



**HAL**  
open science

## Long Life Application dedicated to smart-\* usage

Riadh Karchoud

► **To cite this version:**

Riadh Karchoud. Long Life Application dedicated to smart-\* usage. Other [cs.OH]. UPPA, 2017. English. NNT: . tel-02437285

**HAL Id: tel-02437285**

**<https://univ-pau.hal.science/tel-02437285v1>**

Submitted on 13 Jan 2020

**HAL** is a multi-disciplinary open access archive for the deposit and dissemination of scientific research documents, whether they are published or not. The documents may come from teaching and research institutions in France or abroad, or from public or private research centers.

L'archive ouverte pluridisciplinaire **HAL**, est destinée au dépôt et à la diffusion de documents scientifiques de niveau recherche, publiés ou non, émanant des établissements d'enseignement et de recherche français ou étrangers, des laboratoires publics ou privés.

**Universidad del País Vasco (UPV)**  
**Université de Pau et des Pays de l'Adour (UPPA)**  
**Ecole Doctorale des Sciences Exactes et Leurs Applications**  
**LABORATOIRE INFORMATIQUE – LIUPPA**



## **Long Life Application dedicated to smart-\* usage**

Présenté par

**Riadh Karchoud**

---

Pour obtenir le grade de **DOCTEUR** de l'**UPPA** et l'**UPV**

Spécialité : **Informatique**

Soutenance le 14 Décembre 2017

---

### **Devant le jury composé de**

M. Philippe ROOSE	Directeur de thèse
M. Marc DALMAU	Directeur de thèse
Mme. Arantza ILLARRAMENDI	Directeur de thèse
M. Jean-Louis PAZAT	Rapporteur
M. Noel DE PALMA	Rapporteur
M. Sergio ILARRI	Examineur
M. Alfredo Goni	Examineur
M. Jean-Paul ARCANGELI	Examineur

.

*Long Life Application dedicated to smart-\* usage*

*By*

**Riadh Karchoud**

## . *Dédicaces*

J'adresse mes sincères remerciements au professeur Jean-Louis PAZAT et au professeur Noel DE PALMA pour avoir consacré leur temps pour rapporter mon travail de thèse.

Je remercie également M. Alfredo GONI, M. Jean-Pierre ARCANGELI et M. Sergio ILARRI d'avoir bien voulu faire partie des membres de mon jury. Merci à Sergio pour sa bienveillance, ses conseils et aussi son amabilité.

Mes plus sincères remerciements à Monsieur Marc DALMAU et Monsieur Philippe ROOSE, Maîtres de Conférences (HDR) à l'Université de Pau et des Pays de l'Adour, mes directeurs de thèse, pour leur encadrement et leur soutien. La confiance que vous m'accordez m'a permis de mener à bon bien cette thèse. Vous m'avez donné suffisamment de liberté pour choisir la direction de cette thèse. Je remercie également Madame Arantza ILLARRAMENDI pour son encadrement de valeur et son apport considérable à mon travail. Elle n'a jamais cessé d'accroître ma capacité de produire et en même temps celle qui fut capable de me tirer vers le haut quand j'en avais besoin.

J'ai rencontré pendant la thèse ceux qui sont devenus depuis mes meilleurs amis. J'ai apprécié tout ce qu'on a de commun, mais aussi tout ce qu'on a de différent. L'échange culturel que j'ai vécu avec eux, entre la Chine, le Pérou, le Liban, l'Éthiopie, la Thaïlande, le Venezuela, l'Argentine, l'Espagne et la France, je ne l'aurai jamais vécu ailleurs.

Merci à mon amour Meriem pour son écoute, sa patience, sa compréhension et son support inestimable qui m'a permis d'avancer pendant les moments difficiles.

Merci à mes parents Taoufik et Wassila qui m'ont donné l'exemple de comment aimer sans mesure, donner sans raison et se soucier sans attentes. Je vous dois tous!

À toutes ces personnes qui ne m'ont apporté que du bonheur, merci de faire partie de ma vie!

## . ***ACKNOWLEDGEMENT***

This work was supported by the the embassy of France in Spain and by the TIN2013-46238-C(1/4)-4-R, FEDER/TIN2016-78011-C4-(2/3)-R (AEI/FEDER, UE), FEDER/TCVPYR, and DGA-FSE.

## . *Résumé*

De nos jours, les appareils mobiles hébergent de nombreuses applications directement téléchargées et installées à partir d'un "Store" d'applications mobiles. L'existence d'une telle quantité d'applications pour une multitude d'objectifs impose une énorme surcharge sur les utilisateurs, qui doivent sélectionner, installer, supprimer et exécuter les applications appropriées.

En outre, ces applications ont négligé la prise en compte du contexte de l'utilisateur. Elles proposent des scénarios d'utilisation statiques et non évolutifs. Ces applications servent à des fins spécifiques et sont supprimées ou oubliées, la plupart du temps, après la première utilisation. De plus, ces applications ne tiennent pas compte du monde des objets connectés en raison de leur architecture monolithique mise en œuvre pour fonctionner sur des appareils individuels.

La solution proposée et intitulée "Long Life Application" offre une nouvelle façon de répondre aux besoins de l'utilisateur de façon dynamique et distribuée. Elle propose une évolution continue des applications (encours d'exécution) en ajoutant, supprimant, et déplaçant des fonctionnalités sur les appareils utilisés par l'utilisateur. Elle permet, aussi, de modifier le mode d'interaction en distribuant les exécutions sur plusieurs appareils en fonction des besoins de l'utilisateur.

Pendant que l'utilisateur se déplace dans son environnement, l'application détecte des événements environnementaux et construit des situations contextuellement décrites. Ainsi, ce travail vise à offrir un nouveau type d'applications mobiles capables de détecter, de formuler et de comprendre le contexte des utilisateurs puis de réagir en conséquence.

## . *Abstract*

Nowadays, mobile devices host many applications that are directly downloaded and installed from mobile application stores. The existence of such a large amount of apps for a myriad of purposes imposes a huge overhead on users, who are in charge of selecting, installing, and executing the appropriate apps, as well as deleting them when no longer needed.

Moreover, these applications have mostly neglected to take into account the user's context, as they propose static non-evolving scenarios. These applications serve for specific purposes and get deleted or forgotten most of the time after the first use. Furthermore, these apps fail to consider the, soon coming, connected world due to their monolithic architecture implemented to work on single devices.

The proposed long-life application provides a new way to respond to the user's needs dynamically and distributedly. It evolves at runtime by including/excluding business functionalities, updating the interaction mode, and migrating executions on multiple devices according to the user's preferences.

While he/she moves in his/her surroundings, the app detects the occurring events and builds contextually-described situations. So, this work aims to offer a new type of mobile application able to detect, formulate and understand the users' context then react accordingly.

## . *Contents*

. DEDICACES.....	III
. ACKNOWLEDGEMENT.....	IV
. RESUME .....	V
. ABSTRACT.....	VI
. CONTENTS.....	VII
. LIST OF FIGURES .....	XII
. LIST OF TABLES.....	XV
<b>CHAPTER 1 INTRODUCTION .....</b>	<b>1</b>
1. THESIS CONTEXT .....	2
2. CHALLENGES .....	3
3. OBJECTIVES .....	4
4. MOTIVATING SCENARIO .....	5
5. ORGANIZATION OF THE THESIS .....	7
<b>CHAPTER 2 RELATED WORK.....</b>	<b>9</b>
1. INTRODUCTION .....	10
2. DISTRIBUTION ASPECT IN MOBILE COMPUTING .....	11
2.1. <i>Middleware dedicated to pervasive applications</i> .....	12
2.1.1. Background.....	12
2.1.2. Existing middleware solutions.....	14
2.1.3. Comparison and discussion .....	21
2.2. <i>Cloud solutions for distributed applications</i> .....	22
2.2.1. Background.....	22
2.2.2. Existing cloud solutions.....	24
2.2.3. Comparison and discussion .....	28
3. CONTEXT AWARENESS IN MOBILE COMPUTING .....	30
3.1. <i>Contextual-awareness representation models and approaches</i> .....	31



3.1.1.	Key value models .....	31
3.1.2.	Markup Scheme models.....	31
3.1.3.	Graphical models .....	32
3.1.4.	Object-oriented models.....	32
3.1.5.	Logic-based models .....	32
3.1.6.	Ontology-based models .....	33
3.1.7.	Comparison and discussion .....	34
3.2.	<i>Modeling situation-awareness for Context-aware applications</i> .....	34
3.3.	<i>Platforms dedicated to generating context-aware applications</i> .....	35
4.	USER-CENTERED CONTEXT-AWARE MOBILE APPLICATIONS.....	39
4.1.	<i>Existing solutions</i> .....	39
4.2.	<i>Discussion</i> .....	43
5.	CONCLUSION.....	43
<b>CHAPTER 3 LONG LIFE APPLICATION PROPOSAL.....</b>		<b>44</b>
1.	INTRODUCTION .....	45
2.	APPROACH OVERVIEW .....	46
3.	CONTRIBUTIONS.....	47
3.1.	<i>A rich and user-friendly contextual model</i> .....	47
3.2.	<i>A cross-device context detection</i> .....	48
3.3.	<i>A modular orchestration of services</i> .....	49
3.4.	<i>A collaborative situation injection</i> .....	49
4.	APPLICATION'S GENERAL ARCHITECTURE .....	50
4.1.	<i>The User Domain</i> .....	51
4.2.	<i>Kalimucho</i> .....	53
4.3.	<i>Input</i> .....	53
4.4.	<i>Output</i> .....	53
4.5.	<i>The Injector</i> .....	54
4.6.	<i>The Persistence layer</i> .....	54
4.7.	<i>The LLA Core</i> .....	54
4.7.1.	<i>The Parser</i> .....	54

4.7.2.	The Event Manager (EM) .....	55
4.7.3.	The Condition Evaluator (CE) .....	55
4.7.4.	The Action Orchestrator (AO) .....	55
4.8.	<i>The ACL filter</i> .....	55
5.	APPLICATION'S GLOBAL WORKFLOW AND DISTRIBUTION STRATEGY .....	56
5.1.	<i>The deployment strategy of LLA</i> .....	56
5.2.	<i>The workflow of LLA</i> .....	58
6.	CONCLUSIONS .....	59
<b>CHAPTER 4 SITUATION-BASED CONTEXTUAL MODEL .....</b>		<b>60</b>
1.	INTRODUCTION .....	61
2.	SITUATION-BASED CONTEXTUAL MODEL .....	61
2.1.	<i>Abstract modeling level</i> .....	62
2.1.1.	Concepts .....	63
2.1.2.	Operations .....	67
2.1.3.	Situations families .....	67
2.1.4.	Representations .....	68
2.1.5.	Complexity and data formats .....	69
2.2.	<i>Service level</i> .....	71
3.	CONCLUSIONS .....	71
<b>CHAPTER 5 - CROSS-DEVICE SITUATION DETECTION .....</b>		<b>72</b>
1.	INTRODUCTION .....	73
2.	CROSS-DEVICE SITUATION DETECTION MECHANISM .....	73
2.1.	<i>The Input Component (IC)</i> .....	74
2.1.1.	Frequency Manager (FM) .....	75
2.1.2.	Extractor .....	77
2.1.3.	Trigger .....	77
2.2.	<i>The Event Manager (EM)</i> .....	78
2.2.1.	Dispatcher Component (DC) .....	79
2.2.2.	Axes Management Components .....	79
2.2.3.	Situation Manager Component (SMC) .....	80

3.	CONCLUSIONS .....	84
<b>CHAPTER 6 – SITUATION CONTROL AND REACTION STRATEGY .....</b>		<b>86</b>
1.	INTRODUCTION .....	87
2.	SITUATION CONTROL AND REACTION STRATEGY .....	87
3.	CONDITION EVALUATION (CE) .....	88
3.1.	<i>The situation priority model and constraints</i> .....	88
3.2.	<i>Condition Evaluator module's components</i> .....	93
3.2.1.	The User Constraints Component (UCC) .....	94
3.2.2.	The Situation Holder Component (SHC) .....	94
3.2.3.	The Priority Component (PC) .....	95
3.2.4.	Example .....	95
4.	ACTION ORCHESTRATOR (AO) AND ACCESS CONTROL LIST (ACL) DEVICE FILTER .....	98
4.1.	<i>Device capabilities</i> .....	99
4.2.	<i>Service composition model and component requirements</i> .....	100
4.2.1.	Service Composition .....	101
4.2.2.	Component requirements .....	102
4.3.	<i>Matching services to situations</i> .....	105
4.4.	<i>Orchestration and control components</i> .....	106
4.4.1.	Situation Tracker Component (STC) .....	107
4.4.2.	Orchestration Component (OC) .....	108
4.4.3.	Device Management Component (DMC) .....	108
4.4.4.	Example .....	109
5.	CONCLUSIONS .....	117
<b>CHAPTER 7 – SITUATION INJECTION MECHANISM .....</b>		<b>118</b>
1.	INTRODUCTION .....	119
2.	SITUATION INJECTION MECHANISM .....	119
2.1.	<i>User's Injection Process</i> .....	120
2.2.	<i>Collaborative Social Environment's Injection Process</i> .....	121
2.3.	<i>External Providers' Injection Process</i> .....	122
2.3.1.	Government providers .....	123

2.3.2.	Businesses and private companies .....	123
2.3.3.	Institutions/Organizations/Associations.....	124
3.	CONCLUSIONS .....	125
<b>CHAPTER 8 – PROTOTYPE AND VALIDATION.....</b>		<b>126</b>
1.	INTRODUCTION .....	127
2.	ESTABLISHING AND TESTING THE SCENARIO .....	127
2.1.	<i>Pre-Conditions</i> .....	127
2.2.	<i>John’s travel scenario</i> .....	130
2.2.1.	John sets-up LLA.....	131
2.2.2.	LLA injects the necessary data .....	137
2.2.3.	John starts the journey .....	141
3.	RESULTS AND VALIDATION .....	153
3.1.	<i>Performance validation</i> .....	153
3.2.	<i>Time and storage gain</i> .....	155
4.	CONCLUSION.....	156
<b>CHAPTER 9 – CONCLUSIONS AND FUTURE WORK.....</b>		<b>157</b>
<b>BIBLIOGRAPHY .....</b>		<b>160</b>
<b>APPENDIX 1.....</b>		<b>168</b>

## . List of Figures

Figure 1 – Computing evolution towards ubiquity [65].....	10
Figure 2 – Relationship between sensor-networks and IoT [82].....	11
Figure 3 - Middleware basic architecture [34] .....	13
Figure 4 - Reference model of WSN middleware [104].....	14
Figure 5 - The XMIDDLE architecture [13].....	16
Figure 6 - Aura's system [58] .....	16
Figure 7 - The architecture of MUSIC [86] .....	18
Figure 8 - Overview of the MuScADeL process [12].....	19
Figure 9 - The Osagaia component [32] .....	20
Figure 10 - Cloud layered Architecture .....	23
Figure 11 - CHOReOS architecture [8].....	24
Figure 12 - BlueMix Architecture [38] .....	25
Figure 13 - Flybits workflow [36].....	26
Figure 14 - Context-aware Provisioning Architecture [66] .....	27
Figure 15 - Computation architecture for context-aware citizen services for smart-cities [64].....	28
Figure 16 - Context and Context-aware provisioning [66] .....	30
Figure 17 - Class hierarchy diagram for [47] context ontology.....	33
Figure 18 – Cyberdesk’s runtime architecture diagram [27].....	36
Figure 19 - Care droid's architecture [30] .....	36
Figure 20 - WildCAT's logical model [25].....	37
Figure 21 - Class diagram of the application Places2Go and its relationship [26] .....	38
Figure 22 - LLA PROPOSAL OVERVIEW.....	46
Figure 23 - LLA's General Architecture.....	51
Figure 24 - User's domains .....	52
Figure 25 - LLA running across devices .....	56
Figure 26 - Deployment strategy for starting LLA .....	57
Figure 27 - Deployment strategy for stopping LLA .....	58
Figure 28 - Situation representation model .....	62

Figure 29 - Situation's projection axes ..... 65

Figure 30 - Exception's representation model ..... 66

Figure 31 - First-level situation representation ..... 67

Figure 32 - Second-level situation representation ..... 68

Figure 33 - Third-level situation representation..... 68

Figure 34 - House alarm situation representation..... 69

Figure 35 - Situation branching ..... 70

Figure 36 - Cross-device situation detection component architecture..... 74

Figure 37 - The input component internal process..... 75

Figure 38 - Situation identification process ..... 78

Figure 39 - The dispatcher component..... 79

Figure 40 - Time Manager Component ..... 80

Figure 41 - The Situation Manager Component..... 81

Figure 42 - Filtering layers of situations ..... 89

Figure 43 - Lock zones and priorities ..... 90

Figure 44 - Graphical representation of lock zones ..... 91

Figure 45 - Morning Busy Zone representation ..... 92

Figure 46 - Work Busy Zone representation ..... 92

Figure 47 - Sleeping Dead Zone representation..... 93

Figure 48 - Condition Evaluator's internal architecture ..... 93

Figure 49 - User Constraints Component ..... 94

Figure 50 - Situation Holder Component..... 94

Figure 51 - Priority Component..... 95

Figure 52 - Example scenario representation ..... 96

Figure 53 - Service composition architecture ..... 101

Figure 54 - Video chat service composition graphical representation..... 104

Figure 55 - Monthly Work Meeting full representation ..... 106

Figure 56 - AO and ACL internal architecture ..... 107

Figure 57 - Situation Tracker Component..... 107

Figure 58 - Orchestration Component ..... 108

**Figure 59 - Device Management Component..... 108**

**Figure 60 - Scenario portion..... 109**

**Figure 61 - Situations service layers ..... 111**

**Figure 62 - The Injector's workflow ..... 119**

**Figure 63 - Concert event situation ..... 122**

**Figure 64 - Border closing situation ..... 123**

**Figure 65 - Parking situation ..... 124**

**Figure 66 - Training situation ..... 124**

**Figure 67 – Authentication UI in LLA..... 128**

**Figure 68 – Defining the encryption key ..... 128**

**Figure 69 – Defining home location using LLA ..... 129**

**Figure 70 – Adding a new situation using LLA’s UI..... 130**

**Figure 71 – John’s travel scenario steps..... 131**

**Figure 72- John's defined locations ..... 131**

**Figure 73 – News Situation and Wakeup Alarm Situation graphical representations ..... 133**

**Figure 74 - House Alarm Situation graphical representation ..... 133**

**Figure 75 – Morning Preparation Situation graphical representation..... 133**

**Figure 76 – LLA web application for injecting situations from external sources ..... 137**

**Figure 77 - Print screens of LLA's output for step 1..... 142**

**Figure 78 - Print screens of LLA's output for step 2 and 3 ..... 143**

**Figure 79 - Print screens of LLA's output for step 5..... 145**

**Figure 80 - Print screens of LLA's output for step 6..... 146**

**Figure 81 - Print screens of LLA's output for step 7..... 148**

**Figure 82 - Print screens of LLA's output for step 12..... 151**

**Figure 83: Overtime performance of LLA (10 situations)..... 154**

**Figure 84: Overtime performance of LLA (100 situations)..... 154**

**Figure 85: Overtime performance of LLA (1000 situations)..... 154**

# List of Tables

<b>Table 1: Comparing middleware .....</b>	<b>21</b>
<b>Table 2: Comparing Cloud platforms .....</b>	<b>29</b>
<b>Table 3: Comparing context modeling approaches.....</b>	<b>34</b>
<b>Table 4: Comparing context-aware end-user applications.....</b>	<b>42</b>
<b>Table 5: Time primitives .....</b>	<b>63</b>
<b>Table 6: Location primitives .....</b>	<b>64</b>
<b>Table 7: Activity primitives.....</b>	<b>64</b>
<b>Table 8: Time*Activity primitives .....</b>	<b>64</b>
<b>Table 9: Time*Location primitives .....</b>	<b>65</b>
<b>Table 10: Location*Activity primitives .....</b>	<b>65</b>
<b>Table 11: Situation analysis by the Event Manager's components .....</b>	<b>83</b>
<b>Table 12: Situation filtering by the Condition Evaluator's components .....</b>	<b>97</b>
<b>Table 13: Samsung Gear S3 capabilities .....</b>	<b>100</b>
<b>Table 14: Example of User-Domain .....</b>	<b>112</b>
<b>Table 15: Situation analysis by the Event Manager's components .....</b>	<b>114</b>
<b>Table 16: John's locations data.....</b>	<b>132</b>
<b>Table 17: John's external injectors.....</b>	<b>132</b>
<b>Table 18: John's defined lock zones .....</b>	<b>134</b>
<b>Table 19: John's user-domain.....</b>	<b>135</b>
<b>Table 20: LLA's core modules on step 1 .....</b>	<b>141</b>
<b>Table 21: LLA's main modules results for step 2 and 3 .....</b>	<b>142</b>
<b>Table 22: LLA's core modules on step 4 .....</b>	<b>144</b>
<b>Table 23: LLA's core modules on step 5 .....</b>	<b>144</b>
<b>Table 24: LLA's main modules results for step 6.....</b>	<b>146</b>
<b>Table 25: LLA's main modules results for step 7.....</b>	<b>147</b>
<b>Table 26: LLA's main modules results for step 8.....</b>	<b>147</b>
<b>Table 27: LLA's main modules results for step 9.....</b>	<b>149</b>
<b>Table 28: LLA's main modules results for step 10.....</b>	<b>149</b>



<b>Table 29 : LLA's main modules results for step 11 .....</b>	<b>150</b>
<b>Table 30 : LLA's main modules results for step 12 .....</b>	<b>150</b>
<b>Table 31: LLA's main modules results for step 13, 14, and 15.....</b>	<b>151</b>
<b>Table 32: Measurements of performance, accuracy, and sustainability .....</b>	<b>154</b>
<b>Table 33: Comparison of LLA and classical mobile store approach.....</b>	<b>156</b>

---

---

*Chapter 1 Introduction*

---

## 1. Thesis context

Nowadays, mobile devices are hosting a large amount of applications for multiple purposes. These applications try, in their own categories (social, work, entertainment, etc.), to fulfill the needs of the user. But the diversity of those needs and the conditions surrounding them makes it a challenge for mobile applications to accurately understand users and respond to their needs.

Since the appearance of the first native mobile application (mobile apps) on the Apple Store in 2008 and the Android OS later that year, the mobile apps world has seen three major transformations [71]. It started, between 2008 and 2010, by the information appliance era where the apps transformed the phone into a mono-purpose device serving as a tool for a specific need (calculator, agenda, emails, etc.). In 2011 came the era of 'Home apps', where applications struggled to gain the focus of the user by being filled with tabs of multiple functionalities and services (news, entertainment, social, etc.) but with no consideration to what the user needs. The third phase of apps as service layers, or "the new age of mobile apps", is the "Era of no apps" where applications are hidden in the background taking advantage of the computing power of mobile devices and waiting for the right moment to manifest. This era started in 2014 but is still transforming the market and pushing the technology towards a connected ecosystem where applications are modular, distributed and intelligent. Apps show up only when necessary, without making the user go to a specific store or install pre-packaged bundles (applications).

Current mobile applications, like the ones we download now, serve for specific purposes and get deleted or forgotten most of the time after the first use. Anindya Datta says that "An app that's retained by 30 percent of downloaders is considered sticky" [108]. When speaking to USA Today, he stated that an estimated 80 to 90 percent of apps are eventually deleted from users' phones for being stale and static. In a more recent study [99], statistics show that only 25 percent of users return to any given application after the first use.

Moreover, in pervasive environments (e.g. smart-homes and smart-cities), the number of devices, sensors, GPS modules, services, and applications are strongly multiplying. This rise is consequently raising a considerable challenge regarding data management and systems heterogeneity. This challenge will provoke a huge multiplicity of applications (to install/uninstall), configurations, redundant data and profiles and duplicated functions.

Finally, the growth of this network of smart connected devices obliges app developers to consider ubiquitous and pervasive computing. Nowadays, many users own more than one mobile device but with the rise of the Internet of Things (IoT) and smart-\* (cities, home,

buildings, etc.), users will be confronted and be expected to handle multiple devices simultaneously (6.58 devices per person in 2020 [24]).

## 2. Challenges

In this context, the need to have mobile applications, able to understand the user and manage his/her daily situations regardless of their nature or categories, arises. Nevertheless, before we propose our solution to these problems, we should understand the nature of everyday end-users needs. The problem comes from the fact that users have repetitive habits that they perform on a regular time basis, and evolving needs, that continuously change and shift according to their physical and social environment. These reasons raise the issue of the relevance of the services that are automatically offered by this type of applications in order to respond to certain situations.

Contextual engagement is the key to overcome this challenge. In the specialized literature, we can find different proposals in the area of context-aware applications. But in general, they only partially cover the users' needs because:

Firstly, they focus their work on understanding his/her context under a specific limited area of expertise (museum guided tours [16], context-aware healthcare, smart-transportation, etc.) in which users and developers, with no expertise in those domains, could not either improve or adapt the application to behave accordingly to the actual requirements of the user.

Secondly, for the lack of dynamicity in the predefined rule-based systems that cannot be either extended to cover wider use cases or enriched to handle more precisely specific personal situations.

Finally, most of the context-aware applications focus either solely on one device (on which they are installed) or on a complex network of sensors that should be installed all around the user in order for their solutions to run correctly.

With a large variety of use cases, diversity of needs and multiplicity of devices, it becomes a necessity to have one solution to manage everything. We call this kind of solutions "Long Life Application" (LLA) or "Eternal Applications" as they run ubiquitously, and evolve constantly by changing their behavior and offering a variety of services according to the user's needs.

### 3. Objectives

Lately, end-users are getting accustomed to a high level of comfort (responsive design, optimized user experience, fast internet, etc.) and expect applications to make their daily life easier. Studies on computer-human interactions lead the developers to optimize and minimize the user's intervention by adapting their applications' design and workflow towards offering the easiest and fastest User eXperience (UX). Therefore, comes the need to focus the attention of the mobile user on one application to manage other applications (services); to offer the widest range of possibilities; to exploit the biggest number of interactions and shared knowledge available to the user.

This proposal combines the strength of two important research areas: Ubiquitous Distributed Computing and Context-Awareness dedicated to the mobile user. For that purpose, we re-think the architecture of applications dedicated to stand-alone devices and target liquid applications [4, 7]. We reconsider also the dynamicity and reactivity of mono purposed applications and aim towards situation-aware applications. Our solution proposes improving the user's mobile experience by overcoming the rigidity of existing mobile applications and by handling the user's multiple expectations in various domains.

Overall, the objective of this proposal is to present a user-centered, context-aware (situation-based) mobile application able to manage everyday situations and react to them by adapting the application to the needs of the user.

Our proposal is dedicated to everyday use. It offers its services to the consumers of mobile applications that until now search, find, install, update and delete their applications on their devices. Therefore, we propose a Long Life Application that would provide the suitable services and applications in a transparent way for the user, according to his/her needs and to the current context.

Our vision of this application is centered on one user in his/her connected environment, that we call user-domain, making it a distributed mobile application by definition. This app needs to give the user a new level of comfort and mobile user experience by replying reactively and proactively to his/her every need and without being confused between the large diversity of apps and devices.

This solution allows the user to properly use his/her soon-coming smart environment (composed by his/her own computing devices and other surrounding devices in the Internet of

Things) without any confusion due to the multiplicity of devices and the heterogeneity of systems available.

Moreover, we cannot ignore the exponential growth of the number of apps, the time spent on apps and the money made by apps [5]. This growth is due to the adoption of the best software practices in engineering, particularly software reuse practices, which contributed to this rise despite the lack of efficiency of mobile app developers. According to [56], 17.109 mobile apps were a direct copy of another app.

This confuses users and pushes them to question the reliability and performance of the downloaded apps. Besides that, this increasing number is unnecessarily overloading app markets, users, and devices. Rather than reinventing the wheel, Android and iOS developers became comfortable turning to the “lazy” work [20] for building blocks for software. This practice made programmers more pragmatic and more focused on app ideas rather than getting all the credit for the software stack on which it’s built. In this scope, our solution proposes to the developers to build their services from a stack of already built components which can be orchestrated, on demand, to provide the wanted experience to the user.

#### **4. Motivating scenario**

Paul Féval said in *Le Bossu* (1857): « Si tu ne viens pas à Lagardère, Lagardère ira à toi!” This citation translates to: if you do not come to Lagardère, he will come to you. It inspired us to make the app go for the user even if he/she does not go for it.

With the rapid growth in the use of smartphones and mobile applications, new ways for the tourism industry to connect with their visitors while traveling has been created [14]. We apply our proposal to this area by presenting the following scenario.

Consider John, a 52 years old History teacher from London, who plans a one-week trip to the Basque Country on the 22nd of November 2017. The main reason for this trip is to take a relaxing vacation and discover the beauty of the region. But John also plans to use this vacation time to treat his thoracic trauma condition by visiting the thermal sources across the area. He plans also to write a paper on the history of these thermal cities and its patrimony.

In order to organize this trip, John needs to do three tasks; He must inform the university (his employer) about this trip and about its academic value and its benefits on his health. The university frees his schedule and informs him of the important meetings and tasks that he should not neglect. He must also contact a travel agency and give them all the details related to this

trip and his preferences (period, preferred accommodations, health status, budget, etc.) in order to have the most optimal and interesting vacation; Finally, John must notify his family and friends.

On Day 1, John will travel from his house to the hotel (in his destination) city while passing by different locations and environments. Upon leaving his house, the application activates the security alarm and shows him the map to the airport on his smart-car monitor. When arriving at the airport, the airport parking services guide John to the nearest empty spot. As he enters the airport terminal, it shows him a map of the building and information about his flight registration/boarding gates. At 11 am (flight time), the application puts the phone into airplane mode and proposes some entertainment services (games, music, reading, etc.). Upon arrival, the application deploys the same services for the arrival airport. John goes to the nearest rental car service to take the car that the agency rented for him. The application allows John to add the car as one of his connected personal devices for those days in order to be used when needed. While driving to the hotel, he receives a notification from the university about an urgent meeting that starts when he arrived at the hotel's parking. When he enters to the hotel, the app launches the automatic check-in service on John's phone. With this service, he can receive all needed information breakfast time, Wi-Fi code, etc. He agrees to the terms and signs digitally to finalize the check-in. He gives his luggage to the hotel and goes immediately outside since it is still early.

John goes to Bayonne's Office of Tourism. He scans a QR code in front of the office which provides the application with information about the nearby events and provides John with a free ticket to the Basque Museum. John decides to go to the museum. When he arrives there, the app provides him with his free ticket and helps him to navigate inside the museum.

On this day, John has his first thermal session recommended by his doctor. He goes to "Cambo-les-Bains", a nearby thermal city, where he does his session. While he is there, the application monitors his health data and stops all other notifications in order to not disturb him. After the session is over, John heads back to the hotel.

When he gets exactly in front of his room, an NFC key service is deployed on his smart-watch to open the door. John takes a shower and stays in his room. He adds the room TV to his devices and uses it to watch his favorite show. Each evening, John usually takes dinner, drinks his medicine, and watches some news and a movie before going to sleep. The application is used to recognize his habits and to give him the needed services to do so. But now it recognizes

that he is in a different place, surrounded by different devices so it adapts accordingly. Finally, it calls his daughter via video chat before he goes to sleep.

This first day gives a clear idea of what to expect from the application. The rest of the days go as planned.

This scenario illustrates the change of needs, multiplicity of devices and evolution of the application. It shows the real need for such kind of application to facilitate most of our redundant tasks and handle new ones all day long. In order to offer these features to John, the LLA should be aware of his situational and physical context. Situational awareness provides John with a clear understanding of his needs and therefore responds accordingly. Physical awareness offers him the freedom and power of using his connected environment and provides him with a full management over his wide range of different devices. This need for awareness raises a number of challenges and requires technological and theoretical competencies related to mobile applications.

## 5. Organization of the Thesis

The chapters of this report are organized as follows:

- **Chapter 2: Related Work**

We need to specify that our related work tackle apps dedicated to single end-users for everyday scenarios. Therefore we study the tools necessary to build these applications and we compare some finished works offering this kind of applications.

- **Chapter 3: Long Life Application proposal**

We define clearly what we mean by Long Life Application and how it improves the limitations of other works. In this section, we describe our approach to implement LLA by describing the workflow and major concepts that will enable the application to respect our objectives and contributions.

- **Chapter 4: Situation-based contextual mode**

This chapter presents our contextual model thoroughly. We redefine clearly what we mean by the situation and how it could represent a big variety of needs and events for an end-user in his daily life.

- **Chapter 5: Cross-device context detection**

Here we present how we extract context from multiple devices in order to detect a situation. We explain the mechanisms behind this detection.



- **Chapter 6: Service control and reaction strategy**

In this chapter, we continue to explain the part of our approach dedicated to managing the running situations, their priorities, and their services by monitoring the user's devices and controlling their accessibility.

- **Chapter 7: Situation injection**

Here we present how we propose to enrich the situations to make the application more dynamic by showing the various sources and examples where this is useful.

- **Chapter 8: Prototype and validation**

In this chapter, we re-introduce the motivating scenario briefly and then proceed to show how we use our proposal to answer to the needs of the user in the presented scenario. We also show the obtained results that demonstrate the validity of our solution.

- **Chapter 9: Conclusion and future work**

Finally, we provide a summary of our work and suggests possible future research directions.

---

---

*Chapter 2 Related Work*

---

## 1. Introduction

The technological advancements, related generally to hardware and more specifically to semiconductors, pushed the computing world to a high-speed evolution (see Figure 1) that gave birth to areas that until a decade ago were considered as science-fiction. From mainframe computing to ubiquitous computing, researchers kept pushing the boundaries in order to achieve higher, faster and better use of these technologies.

Currently, we are living in the era of ubiquitous computing which provided the possibility to have more and more mobile applications on more competent devices. Consequently, the continuous rise of mobile applications opened the door for an unmatched number of diverse possibilities of what users can do and expect to do. Due to the high demand of apps and the unstoppable growth of app stores, the computing world is slowly shifting towards an interconnected, distributed, and context-aware digital ecosystem.

Meanwhile, the hardware is becoming cheaper, faster and more available. The Internet is getting faster and accessible almost everywhere. Cloud is offering more storage, more possibilities, and more flexibility. All these factors combined influenced developers and researchers to re-think mobile applications each in their own vision of a ‘future application’ that will revolutionize the user experience and harness the power of this diverse connected world. The idea of our work tackles the edge of the computing technology as shown in Figure 1 by combining context awareness with IoT.

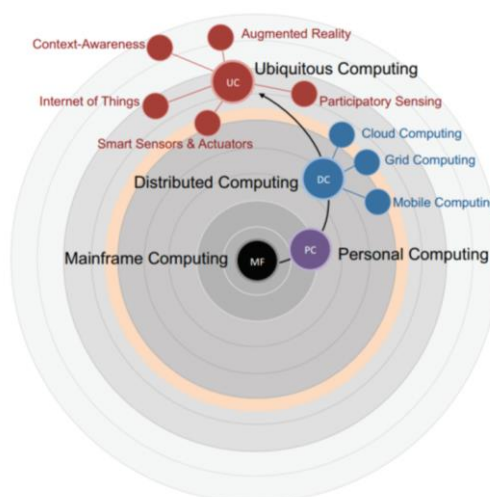

Figure 1 – Computing evolution towards ubiquity [65]

By 2020, there will be up to 50 to 100 billion devices connected to the Internet [81]. This huge number raises the crucial question of how applications can be beneficial for the users in handling the multiplicity of devices and in backward, how these devices might contribute to constructing more efficient applications. Building these applications requires understanding the relationship between the lower levels of sensors and actuators, which construct the main entities of the IoT, the middleware, which provides the management and harmonization of those entities and, finally, the application and service layer visible to users (see Figure 2).

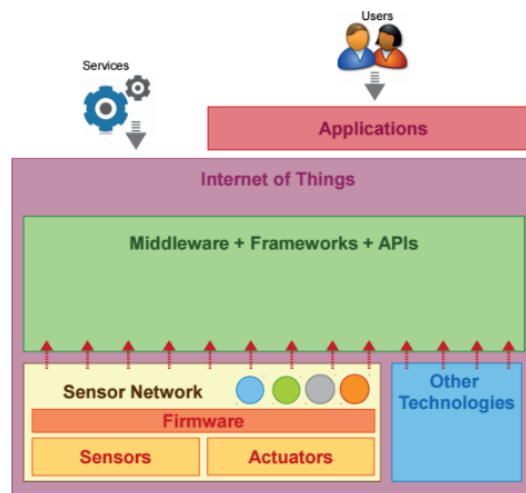

Figure 2 – Relationship between sensor-networks and IoT [82]

## 2. Distribution aspect in mobile computing

The massive use of new technologies has led to a dramatic multiplication of a wide range of applications, different usages, and a huge amount of information. Using many different devices (home and professional PCs, smart-tv, smartphones, etc.) made the user quite confused. Therefore, we have to consider the fact that the user will continuously be using various personal devices, switching from his PC to his phone, from his phone to the TV set, etc.

Thus, the first pillar of our proposal is distribution. The central architectural challenge in supporting computational needs of mobile users is to satisfy two competing goals. The first one is to maximize the use of available resources that is, effectively exploiting the increasingly pervasive computing and communication resources in our environments. The second one is to minimize user distraction and drains on user attention.

Today, a major source of user distraction arises from the need for users to manage their computing resources in each new environment, and from the fact that the resources in a particular environment may change dynamically and frequently.

Moreover, the issue that users face now is that their applications are downloaded/installed/ran on one device. As a Java application, which is compiled as a single JAR file where all the code base is tightly coupled, mobile applications currently follow the same logic. For Android, an app is an APK artifact compiled and installed on only one device with no possibility of being broken into modules that could be distributed and communicated with remotely. This Monolithic Architecture [102] obliges the user to install (duplicate), fully, the same app on all of his devices in order to have an instance of this app everywhere. To answer to this challenge, researchers realized the need to build distributed applications able to run simultaneously on multiple devices regardless of OS, hardware or network. These applications are based on the theory of decomposing features (service/component = feature/purpose).

Distributed Mobile Applications (DMA) are designed, developed and assembled in order to provide the desired final product. Their decomposition ensures that each entity is only used to perform a specific task in a particular context. These entities must comply with a more abstract architecture (Framework) to manifest when they are needed and disappear after having served their purpose. They must be able to communicate in a transparent way and transfer data through the network. DMA trades traditional monolithic architectures with micro-services architectures that allow a complete flexibility, autonomy, and continuity to the overall application. Beneath this DMA, two families arise; the first is cloud distributed computing solutions that offer services reachable from different terminals and the second is Middleware solutions that are dedicated to ensuring the sustainability of pervasive applications. Each has its advantages and drawbacks, but both serve the same purposes (sharing computing power, running regardless of the heterogeneity, sharing data, decomposing the application, fault tolerance etc.).

## **2.1. Middleware dedicated to pervasive applications**

### **2.1.1. Background**

In mobile computing architectures, a distributed platform (middleware) is “a layer of software above the operating system but below the application program that provides a common programming abstraction across a distributed system” [10] (see Figure 3). The network is implemented by the use of the same technique for exchanging information involved in all applications using mobile components. These components provide communication between the involved terminals regardless of the hardware and software features, of network protocols, and

of operating systems. The most common technical information exchange is the exchange of messages, calling remote procedures and manipulation of remote objects.

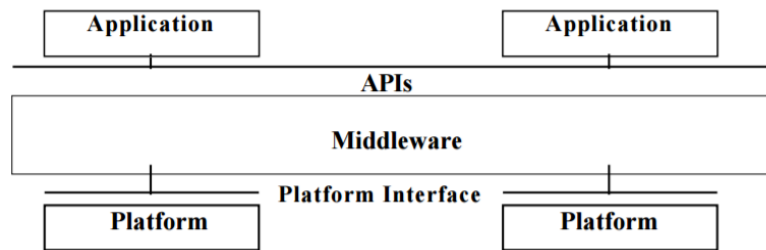

Figure 3 - Middleware basic architecture [34]

Using middleware changes the way how developers construct their applications by considering a new kind of architecture. When working in heterogeneous environment, the modularity of the proposed application becomes crucial. Therefore, the implementation process of the produced applications should respect the paradigm of the middleware on which it is based on.

Thus, the need for Component-Based Software Engineering (CBSE) arises. In software engineering, components are viewed as a part of the starting platforms which are service-oriented. Components are the cornerstone in Service-Oriented Architectures (SOA).

This procedure highlights the separation of concerns in respect of the wide-ranging functionalities available throughout a given software system. This approach reflects the code reuse practice to define, implement and compose independent components into overall applications. This practice aims to bring about an equally to extensive degree of benefits for the software itself and for organizations that support such software.

For this purpose, middleware emerged. Middleware is a software used to bridge the gap between applications and low-level constructs is a novel approach to resolve many Wireless Sensor Network (WSN) issues and enhance application development [50]. As shown in Figure 4, every middleware incorporates four major components:

- **Programming abstractions:** APIs providing the programmer with the tools needed to use the middleware.
- **System/domain services:** Ready-to-use services providing implementations to achieve the wanted abstractions.
- **Runtime support:** Extension allowing the operating system to support the middleware services by providing basic middleware features.

- **QoS mechanisms:** Mechanism ensuring the respect of the quality of services related to the constraints of the system.

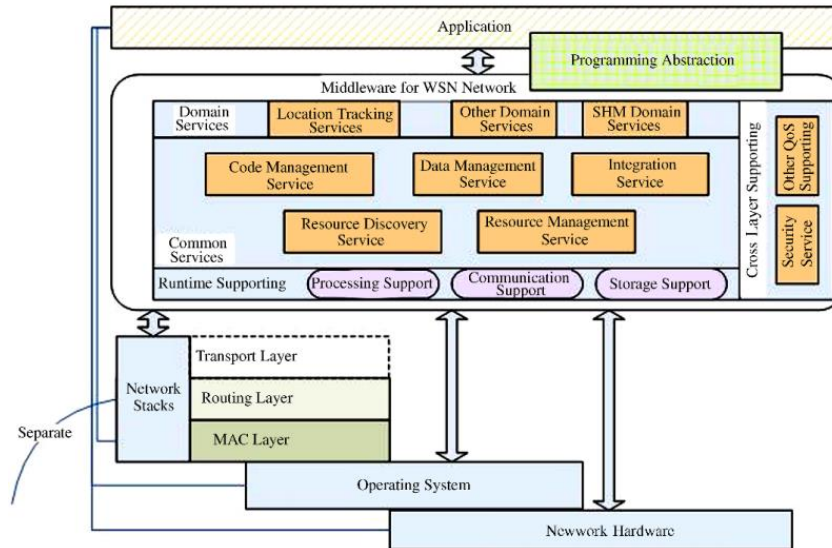

Figure 4 - Reference model of WSN middleware [104]

Adding context-awareness to middleware became a necessity in order to face the new challenges related to the dynamicity of devices' availability and capabilities. The context-aware middleware platforms are an answer to challenges associated with service discovery, mobility, environmental changes and context retrieval [84]. Nonetheless, contextual data retrieval in middleware is usually focused on low-level raw data from devices, sensors, and network (battery level, processing power, network status, etc.).

### 2.1.2. Existing middleware solutions

In this area, researchers took the challenge to propose the middleware of the future that could best unify and harmonize devices, OSs, and networks. Studying these works implies understanding their aim, application domain, advantages, and limitations. In the following, we present the middleware solutions that offer relevant features to our work.

The **Sirac** [85] project, developed at INRIA, provides the needed tools to develop and execute distributed applications. It focuses the developments on two different levels.

The first level considers the distribution aspect of the applications built on this middleware. On this level, Sirac offers the methods and tools to create adaptable distributed applications providing the applications with the needed continuity, maintainability and quality of service in a changing environment (new functions, restructuring, etc.). The second level is the

development of software infrastructure for clustering servers built from interconnected computers. This is relevant when they are used for applications such as Internet data servers.

Even though Sirac has interesting ideas and allows a wide range of possibilities, if the use of clusters grows, because of their cost/performance, it presents a scaling problem and an un-efficient use of global resources.

**SATIN** [110] middleware uses components as the core of its architecture. It proposes a container where various components, or capabilities, of the middleware, are registered. A capability, in SATIN, can take various forms. It can be a library providing some functionalities (e.g. TCP/IP connectivity or compression) or a full application composed of a group of capabilities. Components that contain functionalities that the developer wants to reuse, should be encapsulated in a capability. SATIN also provides a versioning and dependency scheme for capabilities using its capability identifier. Moreover, SATIN is able to dynamically send and receive Logical Mobile Units (LMU), through the use of the Logical Mobility Deployment Capability (LMDC).

SATIN relies on a completely modular architecture. With the exception of the core component, it can be statically/dynamically configured. This allows SATIN to register new capabilities at runtime. In order to develop an application based on SATIN, it is crucial to decompose it into separate capabilities. This decomposition promotes maintenance, code-reuse, and interoperability between applications running on the same or on different terminals. On its domain service layer, SATIN provides applications with multiple useful capabilities like XML parsers and communication paradigms. If not, alternative functionality should be provided in the form of a capability. Its main issue, nonetheless, resides on its dependence on the main core component. If lost, the application could not be sustained. In LLA's case, the sustainability is the most important factor because of dynamic nature of the user, his/her context, and his/her devices.

**Xmiddle** [13] is a data sharing mobile middleware created by the University College of London. It allows mobile hosts a real physical mobility without losing communication threads and information sharing. It does not require, necessarily, the existence of any fixed network infrastructure underneath. Mobile hosts are free to move (physically) at any moment, allowing complicated ad-hoc network configurations in order to recover communication and reconnect to the other hosts in a symmetric (not transitive) way as it depends mainly on distance.

Data is the main focus of Xmiddle, therefore, it allows mobile devices to store their data in a tree-structured and useful way. Tree data models offer a refined accessibility and manipulation



of data thanks to the ability to define; a hierarchy/relation among the different/same level of nodes; a set of primitives for tree manipulation. Figure 5, presents the architecture of Xmiddle.

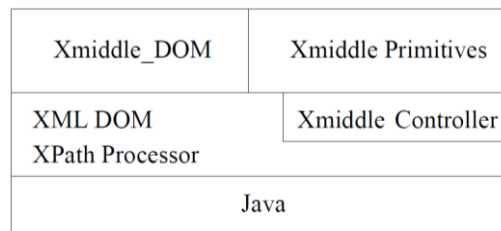

Figure 5 - The XMIDDLE architecture [13]

The contribution that Xmiddle proposes is primarily an approach to sharing that allows online collaboration, offline data manipulation, synchronization, and application dependent data reconciliation. When hosts connect to each other in order to communicate, Xmiddle provides a set of possible access points for the owned data tree needed so that other devices can link to these points to gain access to this information. Basically, the access points link to branches of trees that can be modified and read by other hosts so the host could be able to share data. However, this middleware neglects the four-layered architecture and focuses too much on data without providing sophisticated services or giving developers the possibility to customize their use of this middleware. This work motivated us to give a high importance for the data shared between LLA's components. It also made us consider a collaborative extendable contextual data model (see Chapter 7).

In Project **Aura** [58] at Carnegie Mellon University, they developed a new creative solution based on the concept of personal "Aura". The insight that brought this idea revolves around the idea of personal Aura. This Aura acts as a proxy for the mobile user. In fact, when a user arrives into a new environment, his/her Aura arranges the appropriate resources to help the user to perform the wanted task. Additionally, an Aura comprehends the constraints of the user in the physical context surrounding him/her which relate to the nature of his/her task. Each task may imply/involve different information sources and applications depending on what it is.

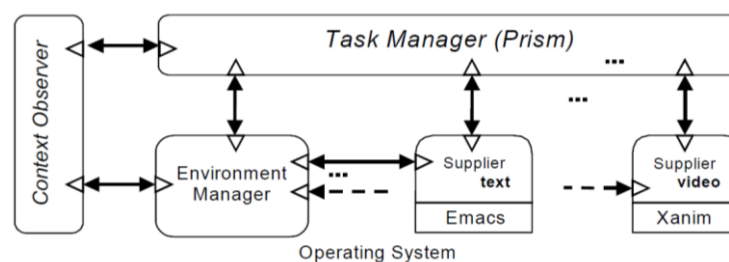

Figure 6 - Aura's system [58]

To enable the action of such a personal Aura, an architectural framework (see Figure 6), that translates the needs to new features and interfaces, is needed. The framework defines placeholders that capture the nature of the user's tasks, personal preferences, and intentions. This information is needed to monitor the environment in order to hide the heterogeneity (OS, network, hardware) from the user and to accordingly build the reaction strategy. This work influenced our proposal by considering the importance of user's tasks while building the context.

The issue of this middleware resides in the lack of modularity of applications. It adapts the way to use the application but not the application itself.

**LIME** [3] is a middleware that follows two principles. It displays physical mobility of hosts and logical mobility of agents, or both when developing applications. LIME adopts a coordination perspective inspired by works on the Linda model [28].

In Linda, processes communicate through a shared tuple space (a multiset of tuples that can be concurrently accessed by several processes) that acts as a repository of elementary data structures, or tuples [3]. This model provides multiple levels of abstractions that allow developers a fast, easy and dependable development of mobile applications. LIME offers control over the context. This context is detected using the mobile units provided by extending Linda operations with parameters (e.g. location) that handle the projections of the user provided by a shared tuple space. Tuple location parameters are expressed in terms of agent identifiers or host identifiers.

Even though LIME is a strong middleware, combining physical and logical mobility it fails to re-adapt to different scenarios. This bounds the number of use cases and applications that could help the user in a fast-changing environment.

The **MUSIC** [86] middleware is an extension of the MADAM [35] planning framework, which supports the adaptation of component-based architectures. MADAM follows an architecture-centric approach that manages the architecture while the application is running. This feature allows the components themselves to be able to control and reason on adaptation aspects in order to provide fully adaptable applications. These applications, built by developers based on the MADAM model, are modeled as component frameworks that give the possibility to dynamically configure functionalities defined by the MUSIC framework (see Figure 7) respecting their implementations.

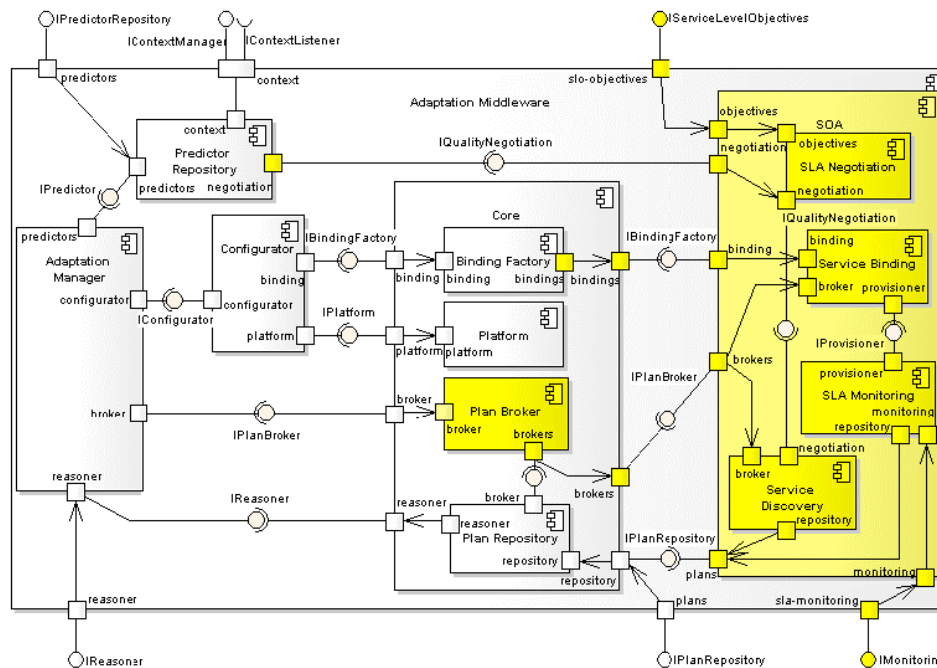

Figure 7 - The architecture of MUSIC [86]

The concept of adaptation-planning frameworks is used to compute and evaluate the utility of alternative configurations in response to context changes and evaluates discovered remote services as alternative configurations for the functionalities required by an application. The MUSIC extension supports self-adaptation of ubiquitous applications to changes in the service provider landscape.

MUSIC motivated our work specifically on the service level of our approach. This means that components and services can be plugged in interchangeably to provide an implementation of functionalities defined by the component framework.

The drawback of this solution is the complexity to build final user-oriented applications due to a large number of parameters that should be taken into account and implemented.

**CARISMA** [63], on the other side, follows a peer-to-peer architecture. It is a mobile computing middleware that uses the principle of reflection in order to build context-aware adaptive applications that install/uninstall services and adaptation policies on the fly. When a contextual change is detected, CARISMA triggers the adaptation automatically for the deployed applications.

In CARISMA, application profiles are used to choose the appropriate plan of action accordingly to the detected context and to select application profiles in order to use utility functions. In the case of a conflict between profiles of different or same application, CARISMA

starts an auction-like procedure to resolve conflicts. The auction-like procedure could present a potential added value when integrated into the MUSIC middleware which provides richer context awareness and therefore a better adaptability. Nonetheless, CARISMA's is limited compared to MUSIC because it does not deal with the discovery of remote services that can trigger application reconfigurations.

**MuScADeL** [12] (Multi-Scale Autonomic Deployment Language) is different from other works because it considers a larger and wider scale of devices. It offers a domain-specific language (DSL) dedicated to building autonomic software deployment of multi-scale systems. MuScADeL focuses on multi-scale deployment properties without exact knowledge of the deployment domain. It gives app designers, who are not necessarily experts in a specific domain, the possibility to build an adaptable application by following their process (see Figure 8) and taking into account the scale and targets of deployments (e.g. servers).

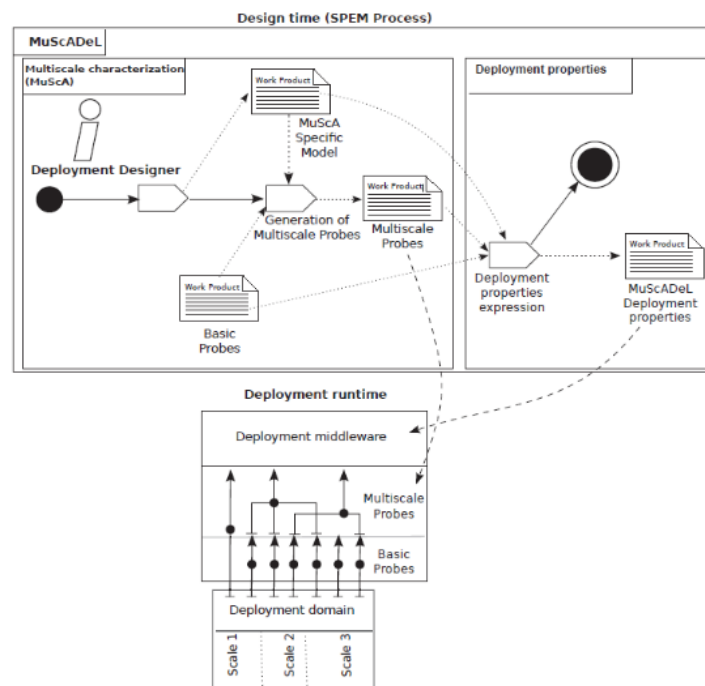

Figure 8 - Overview of the MuScADeL process [12]

Through a model-driven approach, MuScADeL respects a scale awareness foundation called MuScA framework (Multiscale distributed systems Scale Awareness framework). This framework includes a multi-scale characterization process and multi-scale probe generation software. The problem with large-scale systems is that they raise too many challenges and uncertainties related to the quality, relevance, continuity, reachability of deployed services.

Last but not least, **Kalimucho** [23] middleware is a supervision platform that, by being distributed on all peripherals of the application, is aware of the components and connectors deployed and can retrieve context information that they send to it. To do so, it must monitor the operation of the components and circulation of data flows between these components. In order to gather information about these two entities, the use of containers, that provide a solution to managing the hardware and software heterogeneity of peripherals as well as the mobility of peripherals, was chosen.

The Osagaia model [32] suggests separating the business logic contained in a business component from the supervision managed by a container. The Business Component (BC) can receive several input data flows and produce several output flows. Each output flow can be duplicated. The container encapsulates one and only one business component and implements non-functional properties such as lifecycle management, retrieval of data on quality of service and managing communications. This model is presented in Figure 9.

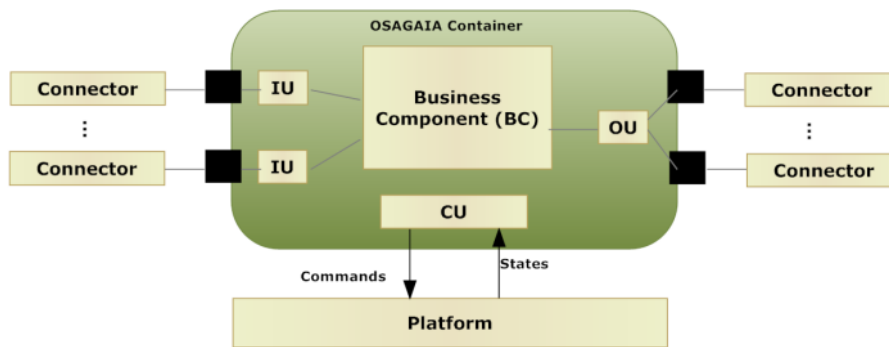

Figure 9 - The Osagaia component [32]

The middleware handles communications between components by supplying the physical medium for information flows. It consists of connectors that the platform sets up between the BCs.

The Kalimucho platform can, therefore, take fully informed dynamic reconfiguration decisions. It can ensure service continuity while taking account of overall sustainability of the application. It is, therefore, necessary to capture all contextual changes, whether they are associated with users' needs for resources or with mobility, and then to interpret these changes to react in the most appropriate fashion. The platform's runtime support is able to reconfigure applications as they are running and to monitor the context. It presents mechanisms to ensure structural reconfigurations (e.g. dynamic redeployments) including functionalities as migration, replacement, etc. It involves modular applications based on distributed software components.

This modularity offers hot-reconfigurable ad hoc solutions guaranteeing the continuity and sustainability of applications over time. Applications based in Kalimucho are designed as a set of interconnected functionalities. Each one is itself made up of a set of software components linked by connectors. These functionalities can be achieved in different ways using different component assemblies. The platform can then manage several functional decompositions corresponding to the various configurations.

### 2.1.3. Comparison and discussion

In table 1, a comparison of the existing middleware is described based on six different criteria. *Application models* represent the key components of these middleware. It is the entity that the platform deploys and controls. The *communication link* is the communication mechanism enabling the components to communicate and exchange data. *Context management* shows the way that these middleware consider context awareness in their approach. As for the *Adaptation* criteria, it describes how the middleware react to contextual changes or other factors (Network status, device capabilities, etc.) by either structurally adapting the application or by making behavioral changes only. Finally, we compare them according to their *strengths* and *weaknesses*.

**Table 1: Comparing middleware**

Middleware	Application models	Communication link	Context Management	Structural/ Behavioral Adaptation	Strengths	Weaknesses
<b>SIRAC</b>	Participants (nodes)	Connection request	Operation context	Static, behavioral	Collaborative work	Rigid architecture
<b>SATIN</b>	Capabilities	LMU	Yes, type not specified	Dynamic, structural	Flexible mobility of services	The dependence on the core component
<b>xmiddle</b>	DOM components	Tree linking via primitives	Location-based	Static	Safe efficient data sharing	Limited context
<b>Aura</b>	Aura components	Aura connectors	Situation recognition proxy	Dynamic, structural	Dynamic Distributed computation	Application composition

<b>LIME</b>	Mobile Agents	Mobile hosts connectivity	Linda tuple space	Dynamic, Structural and behavioral	Combine logical and physical mobility	Adaptability to different scenarios
<b>MUSIC</b>	Components (Web Service, CORBA, or UPnP)	Service proxy binding	Execution status context	Dynamic, structural	Open component environment [33]	Complexity of implementation
<b>CARISMA</b>	Reflections	According to app needs	Policies of app	Dynamic, structural	Resolving conflicts	No service discovery
<b>MuSCaDel</b>	Components	Not specified	Personalized high-level context manager	Dynamic, behavioral	Rich context	No QoS management
<b>Kalimucho</b>	Osagaia components	Korrontea connectors	Runtime Execution Context	Dynamic, Structural	Fully access devices capabilities	Low security level

Upon this study, we notice that every middleware is dedicated to a different kind of application. For example, Xmiddle provides applications focused on data sharing, SIRAC proposes a component-based collaborative work environment for distributed projects, Aura offers a distribution mostly oriented towards sharing the computing power between devices, etc.

In the context of LLA, Kalimucho is the most adequate to the needs of a distributed application dedicated for end users. Kalimucho offers a simple library to implement the component model with capabilities to make fully informed dynamic reconfiguration decisions. Moreover, for mobility and continuity, it serves the true purpose of LLA by providing a full device management and an overall context-aware control of these devices and of the components running within. Lastly, it runs Java code making the portability of the application more efficient and widening the range of possible devices that we can explore (Android phones, PCs, sensors, etc.).

## 2.2. Cloud solutions for distributed applications

### 2.2.1. Background

Cloud computing refers to applications and services that run on distributed networks using virtualized resources and accessed by common internet protocols and networking standards

over different layers (see Figure 10). It is distinguished by the notion that resources are virtual and limitless and that details of the physical systems on which they run are abstract from the user [94].

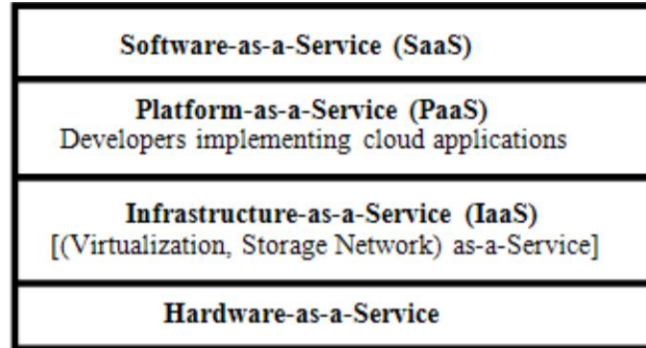

Figure 10 - Cloud layered Architecture

In this scope, we focus on SaaS. Under SaaS, the software publishers/providers run and maintain all necessary hardware and software of their proposed services while users obtain access to these services using the Internet. It uses common resources in order to support different clients simultaneously by providing a single instance of the application's code and data support behind it.

The Economist (2006, p. 61) states simply, "SaaS is quicker, easier and cheaper to deploy than traditional software, which means technology budgets can be focused on providing a competitive advantage, rather than maintenance".

With the exponential rise of mobile apps, Cloud architecture aimed to overlay a new level called Mobile Applications as a Service (MAaaS). MAaaS, Features as a Service (FaaS) or simply Apps as a Service (AaaS) are built with cloud tools and often use both cloud-based and on-device simulators to help the app builder view and test the app prior to deployment. In most cases, the app is built "code-free" or "code-lite" using some form of the object-oriented design process that abstracts most, if not all of the coding from the builder [72].

Once complete, the app is packaged for the target destination by the platform either as completely native code or, in some cases, using a hybrid wrapper. The app is then published from the cloud by the client with their own credentials and with no need to understand complex programming languages.

This concept motivated engineers and researchers to race towards providing their vision of a Cloud platforms and frameworks aimed to facilitate the creation of cloudified applications



dedicated to multiple domains. These frameworks differ in the way they consider the user, their usability, and their application domains.

### 2.2.2. Existing cloud solutions

We studied a number of different platforms that provide the cloud infrastructure to deploy fast, packaged applications on multiple devices for users. These platforms are dedicated to both single end-users and companies. They aim to accompany the soon coming connected smart-cities by delivering orchestrated deployments respecting their programming paradigms and their layered architectures.

CHOReOS [8] implements a framework for scalable choreography development. The goal of CHOReOS is to provide the possibility for app designers, who should be domain experts but with no IT or engineering skills, to develop decentralized Ultra-Large-Scale (ULS) solutions composed of heterogeneous services that are adaptable and QoS-aware.

CHOReOS follows a number of principles for formally grounded abstractions and models (see Figure 11). First, it provides a dynamic choreography-centric development process. Second, it offers a governance and a service-oriented middleware manipulation via an Integrated Development Runtime Environment (IDRE) aimed at overcoming the ULS impact on software system development dedicated to smart-cities.

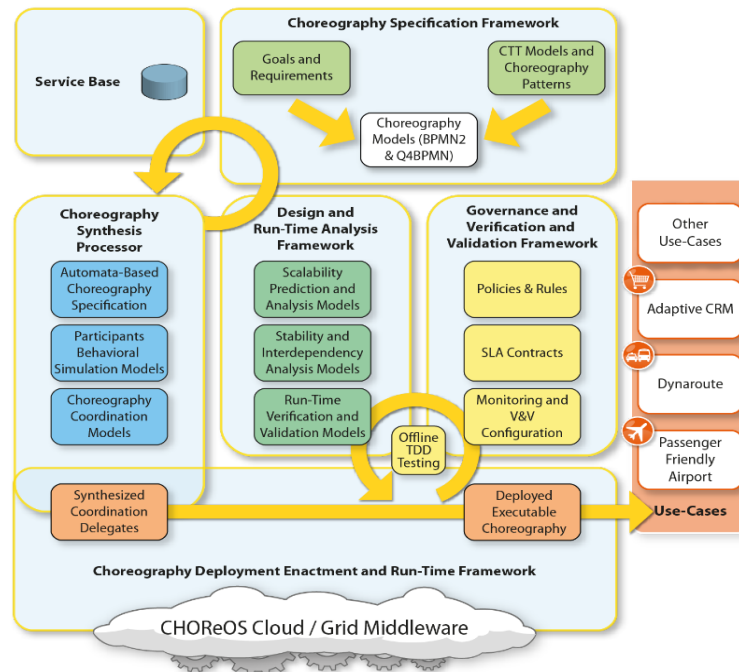

Figure 11 - CHOReOS architecture [8]

Although CHOReOS is a well-designed framework for providing component-based systems, its flaw comes from having centralized service base which makes applications in risk of malfunctioning or missing services due to a problem in reaching that base.

BlueMix [38] is a platform created by IBM dedicated for developers giving them the advantage to create quick small apps for specific needs based on an infrastructure of data and cloud services. The “systems of engagement” concept behind BlueMix is promising. It’s a projection of a new trend that is occurring among solution makers, enterprise software development companies, and complex systems providers.

The IT phenomenon “systems of engagement” represents systems which are used directly by employees/users for redundant uses like emails, collaboration systems, and new social networking and learning systems [65]. They "engage" employees directly by providing services only when needed.

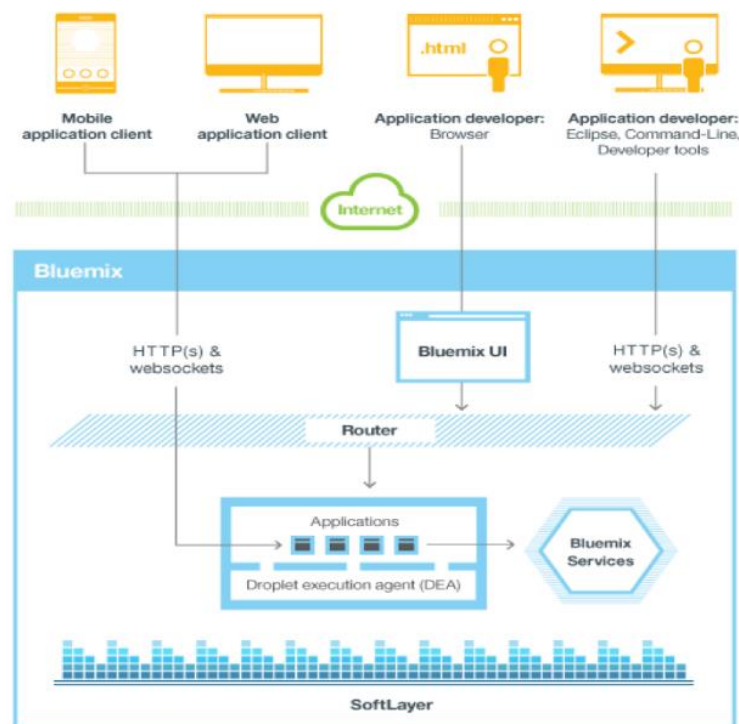

Figure 12 - BlueMix Architecture [38]

IBM mapped the systems-of-engagement model to their own systems providing a high-level layer of applications that relate to specific use cases (see Figure 12). These components/services that compose the app layer, have been implemented in a variety of technologies optimized for performance, safety, and compliance with complex requirements and standards, but they also generate a ton of data that could enable countless user-facing applications. The volume of

streaming data generated by sensors in the telecommunications and automotive worlds cried out for the same kinds of opportunities the cloud offered to app builders in the IT world.

Bluemix stands out from other platforms by giving a lot of options to developers allowing them to easily implement more complex apps. It is built on a big infrastructure of services and data allowing speed deployment of specific need apps. However, it neglects completely the user's point of view.

Likewise, **Flybits** [36] is a cloud-based mobile app creation framework. When a mobile user triggers or enters a Zone, the unique app's content and/or services are deployed based on that context. It is a tool that delivers appropriate applications in the same way as recommendation systems suggest relevant items [105]. Flybits offers an SDK for iOS and Android which simplifies to programmers the process of building context-awareness into their mobile apps without imposing any proprietary development environment or hardware, giving the programmer total freedom of choice in these areas. It provides all of the infrastructure and services needed, so they do not need to build it themselves.

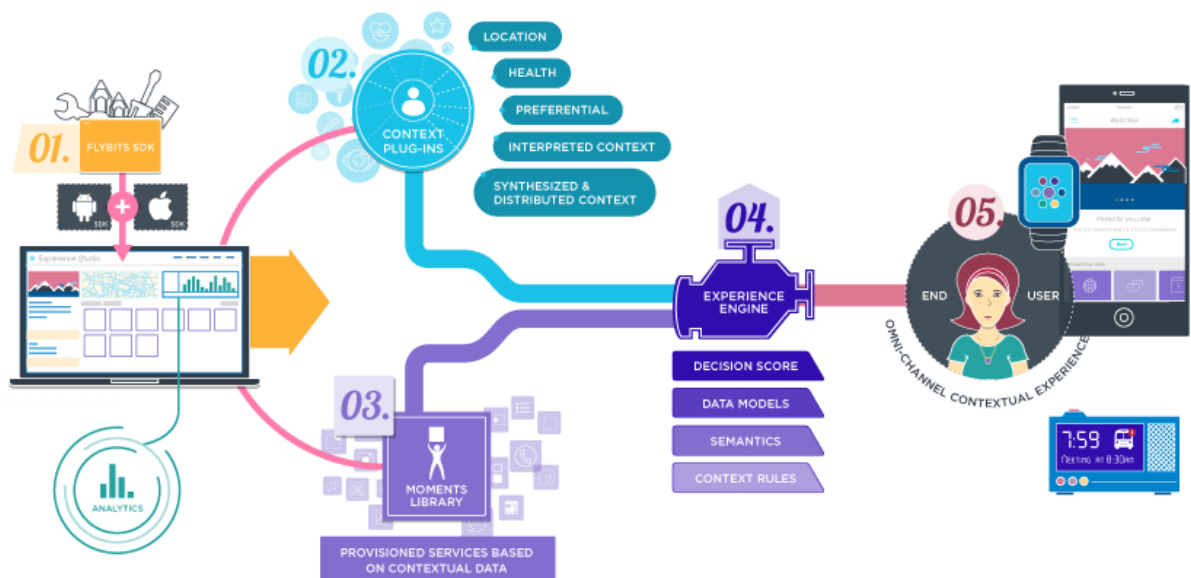

Figure 13 - Flybits workflow [36].

Respecting the workflow presented in Figure 13, programmers can use the Experience Studio to create and change app content and behavior without having to write any additional code.

The limitation of this work is that, although the services are aimed at the user, this platform is dedicated to businesses giving them the hand on what the user should see.

Hyun Jung La and Soo Dong Kim present a different approach in [66] which is more focused on context awareness. The presented framework allows the produced application of firstly capturing context, secondly determining what context-specific adaptation is needed, thirdly selecting and adapting services for the captured context, and finally running the adapted service.

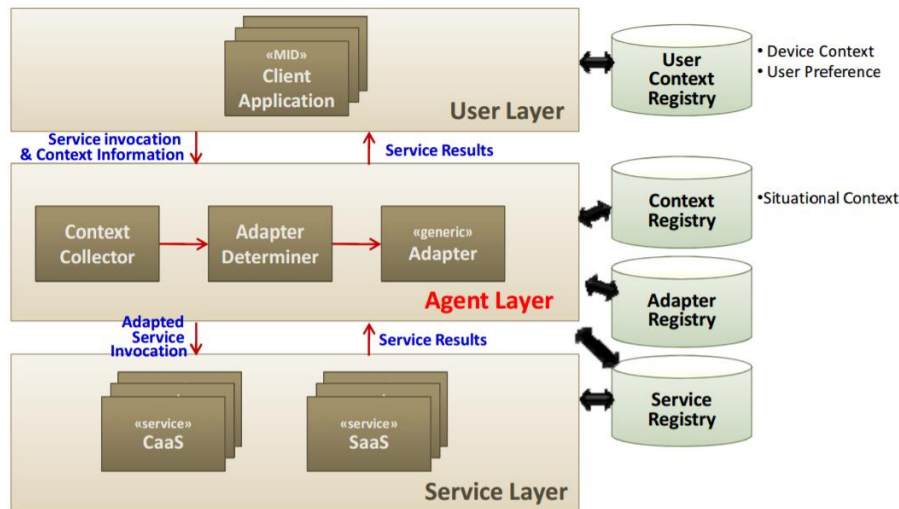

Figure 14 - Context-aware Provisioning Architecture [66]

The architecture of this framework, presented in Figure 14, consists of three layers; User Layer, Agent Layer, and Service Layer. The User layer consists of multiple Mobile Internet Devices (MIDs) on which applications are deployed. The Agent Layer has the task of adapting services by taking into account the preferences of the user and his/her context information. The Service Layer represents the cloud infrastructure running the services contained in the Service Registry used to compose the user's application. They are called on demand after detecting the context and tailoring the services to the specific needs of the user.

Nonetheless, this solution lacks dynamicity as it is dependent on the service registry which can cover a limited range of scenarios and pre-programmed mechanisms of adaptation.

Khan et al. presented the capabilities required in a Cloud environment to acquire integrated intelligence for urban management systems. These capabilities provide a solid foundation to respond to smart cities requirements by developing a context-aware component in a Cloud environment [64].

In [64] the authors present a framework that attempts to define characteristics (what, why, how and who) of the relevant artifacts and associated components. The artifacts are the main

building blocks for the development of cloud-based context-aware services architecture (see Figure 15). This framework adopts, in a generic way, various artifacts, components, standards, and technologies depending on the needs of different applications. It is flexible to provide new artifacts and procedures and also include new technologies and standards for various different users and use cases.

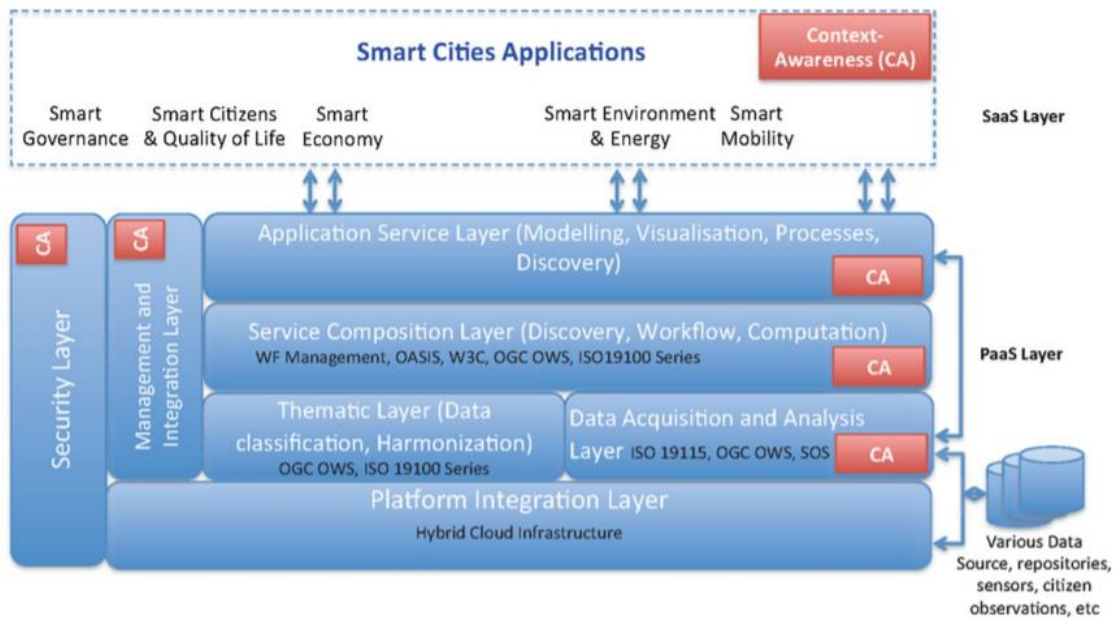

Figure 15 - Computation architecture for context-aware citizen services for smart-cities [64]

Although this framework is built on a multi-layered architecture and provides context awareness to the users, the adaptation of the provided services is generic, which reduces their ability to handle new needs in new application domains.

### 2.2.3. Comparison and discussion

After we studied some solutions, we categorized them according to some criteria that help to show the differences between them. Table 2 summarizes a comparison between the existing frameworks and our proposed Long Life Application.

Table 2: Comparing Cloud platforms

Platform	Architecture	Final product	Strengths	Weaknesses
Choreos	Service Oriented Architecture (SOA)	ULS app deployment choreography	Cover wide range of scenarios on a wide range of devices	Centralized service base
BluMix	Hybrid cloud infrastructure	Event-driven micro services	Fluid and rich engagement system (APIs, services, events, etc.)	Enterprise-oriented with a need of high level of expertise
Flybits	Client/Server	Context-aware user application	Easy to use app creator (Experience studio)	Centralized app provider
[66]	User Layer, Agent Layer, and Service Layer	Context-aware user application	Dynamic context awareness and application adaptation on run-time	Limited scenarios dependent on existing services
[64]	Hybrid cloud infrastructure	Smart-cities Apps	Rich context-aware data extraction	Only generic services offered
LLA	Decentralized	Distributed context-aware mobile application	User-friendly, Dynamic, Reactive Considers multiple scenarios, devices, contexts.	No security management

Compared to other works, LLA is based on a dynamic component architecture able to change continuously in order to keep up with context changes. Thus, it is a dynamic proposal able to detect the context, evaluate the existing conditions, and take action. Although it is a ready-to-use application, LLA is also a framework that can be programmed by both, the final user and other parties, in order to evolve the application and make it more personalized and reactive. It combines the best advantages of the studied platforms. It covers an unlimited range of use cases, it provides an easy way to customize and reshape itself as the app that the end-user needs.

### 3. Context awareness in mobile computing

“Mobile Apps need context to hit the right target” as stated by TechRepublic [88]. Indeed, the main problem with existing mobile apps is their non-consideration for the status (busy, free, working, etc.) of the user needs.

Therefore, these apps need context to aim in an intelligent way their user’s expectancies and to avoid bothering them when no longer needed. The studied middleware and platforms have all shown the potential of context awareness and still try to provide the best solution capable of comprehending, analyzing and reacting to contextual changes, which brings us to the second main pillar of our study: the context awareness.

Therefore, we start by defining the context. According to [17], the context is understood as any information that can be used to characterize the situation of an entity, where an entity can be a person, place, or physical or computation object”. Being aware of the context is termed context-awareness.

In [91] context-awareness is defined as: “Computation is becoming increasingly coupled with the physical world. It is now commonplace for mobile applications and systems to adapt their functionality to user location, connectivity status, device orientation, and remaining battery percentage. This ability for software to sense, react, and adapt to the physical environment has been termed context-awareness”.

The goal of being aware of context is being able to offer the appropriate service accordingly. This step is called context provisioning (see Figure 16) and is the main objective of context-aware applications.

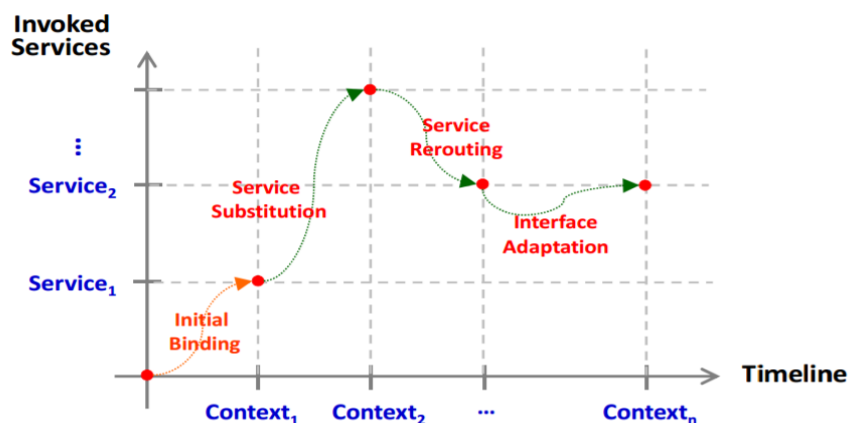

Figure 16 - Context and Context-aware provisioning [66]

### 3.1. Contextual-awareness representation models and approaches

When representing context, there is no shortage of diverse models and approaches. Each researcher proposes their own model and considers different information which relates to the final application that they aim for. Some consider only the location, whereas others focus on sensors. Some use ontologies to represent it, while others propose geometrical-spatial representations. Nonetheless, these representations fall under the specific categories described thereafter. In the literature, several context modeling approaches can be found. Most relevant ones have been classified by Strang & Linhoff-Popien [95] according to the scheme of data structures which are used to exchange contextual information: key-value models, markup scheme models, graphical models, object-oriented models, logic-based models, and ontology-based models.

#### 3.1.1. Key value models

This representation is the most basic model. It pairs a key and value tuple to represent simple context. It uses matching algorithms to detect context when the stored key or value are retrieved. An example of this model is presented in works like Schilit et al. [9]

#### 3.1.2. Markup Scheme models

Like all markup scheme modeling approaches, this is a hierarchical data structure consisting of markup tags with attributes and content. In particular, the content of the markup tags is usually recursively defined by other markup tags.

These models are, usually, based upon a serialization of a more abstract standard called Standard Generic Markup Language (SGML). SGML is the father of all markup languages such as XML. Some of them are defined as an extension to the Composite Capabilities / Preferences Profile (CC/PP) [103] and User Agent Profile (UAProf) [106] standards, which have the expressiveness reachable by RDF/S and an XML serialization. Indeed, these kinds of context modeling methods often extend/complete the basic CC/PP and UAProf vocabulary/procedures to try to better manage complex dynamic contextual information as opposed to more static representations used to represent static data.

An example of this approach is the Comprehensive Structured Context Profiles (CSCP) by Held et al. [51].



### 3.1.3. Graphical models

Graphical models are used to generate a representation derived from an entity-relationship (ER-model) [15]. This approach is efficient in structuring instruments for a relational database in an information system based on context management architectures such as the one described in [55]. Indeed, UML is the most common language used to represent this kind of models. Context Spaces Theory (CST), for example, is a graphical approach for context awareness and situation awareness. CST uses spatial models to achieve a meaningful and easy to understand context representation.

CST aims towards a general context model to help thinking and to describe the context. It offers various design operations for manipulating and utilizing context. The CST concepts use insights from geometrical spaces and the state-space model to guide reasoning about context using geometrical metaphors. The model provides a unified and general way to represent context and enables effective reasoning to be applied over the modeled information.

The foundations of the context spaces theory are provided in the work of Padovitz et al. [17] as an example of how to use this modeling method.

### 3.1.4. Object-oriented models

This representation illustrates the main pillars of oriented programming (Encapsulation, Heritage, and Polymorphism). To describe the context and cover parts of the problems arising from the dynamics of the context in ubiquitous environments, it employs these pillars to its benefit. An example of this use would be shown by the fact that the details of context processing are encapsulated on an object level. It is, therefore, hidden to other components. Therefore contextual information is provided through specified interfaces only.

### 3.1.5. Logic-based models

The notion of context and the contextual logic originally developed by John McCarthy in the field of Artificial Intelligence (AI) aims at providing a solution to the problem of generality, the problem of representing ordinary knowledge and its integration into inferential processes operating on knowledge bases [109].

This kind of representation requires a high level of formality, as the context is defined by a variety of facts, expressions, and rules that need to be checked and validated. Therefore, context

can be managed by being inserted, updated and deleted from a logic based system in terms of facts or inferred from the rules in the system.

An example of logic based context modeling approach has been researched and published by McCarthy et al. [67, 68].

### 3.1.6. Ontology-based models

Ontologies are a promising instrument to specify concepts and interrelations [101, 43]. Context ontology is based on a unified vocabulary allowing representing and sharing context information in a pervasive computing domain.

Ontologies have the advantage of including machine-interpretable definitions of basic concepts in the domain and relations between those concepts. These models are appropriate for describing information, which can be used in our daily life, by a data structure utilizable by computers for wider domains like machine learning and deep learning.

The ontology-based model uses the Web Ontology Language (OWL) to describe the context ontology. OWL is a semantic markup language that can be used to publish and share ontologies on the Internet. A resource in OWL is represented as a class, and the relationship between resources is shown using properties.

Figure 17 is a presentation of a context model based on ontology using OWL to support various tasks in a context-aware middleware. It supports semantic context representation by defining the common upper ontology for context information in general; and providing a set of low-level ontologies which apply to different sub-domains. It models the basic concepts of person, location, computational entity, and activity; describes the properties and relationships between these concepts [47].

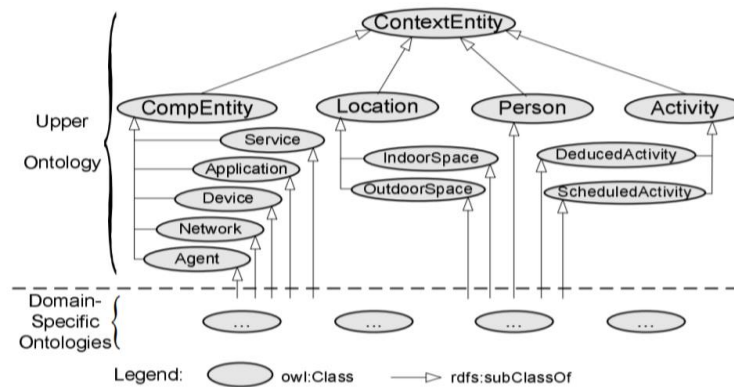

Figure 17 - Class hierarchy diagram for [47] context ontology

The basic concept of this context model is based on an ontology which provides a vocabulary for representing knowledge about a domain and for describing specific situations in a domain.

Ontology-based modeling is considered as the most promising approach, as it enables a formal analysis of the domain knowledge, promoting contextual knowledge sharing and reuse in a ubiquitous computing system, and context reasoning based on semantic web technologies [39].

### 3.1.7. Comparison and discussion

In order to evaluate these approaches, we consider factors that are relevant in the context of LLA. Therefore, the comparison (see Table 3) considers the efficiency of these models regarding the distribution aspect. The composition and administration of contextual models and vary considerably with high dynamics in terms of time, network topology and source.

Moreover, we consider the formality of the model and the richness of data supported by that model. This aspect relates more to the context-awareness aspect of LLA.

Finally, we consider the applicability of these models to user-centered mobile applications for everyday usage.

**Table 3: Comparing context modeling approaches**

<b>Modeling Approach</b>	<b>Distribution efficiency</b>	<b>Formality/richness</b>	<b>Applicability</b>
Key-Value models	-	-	+
Markup scheme models	+	-	+
Graphical models	-	+	+
Object oriented models	+	+	+
Logic models	+	+	-
Ontology-based models	+	+	+

## 3.2. Modeling situation-awareness for Context-aware applications

This modeling approach distinguishes between the concepts of Context and of Situation. Context is the information used in a model for representing real-world situations. On the other hand, situations are perceived as a meta-level concept over context [2]. The process of assessing the association and mapping between context and situations, or in other words, determining

occurrences of situations based on information in a model, is the task of reasoning. This relationship between context and situations is represented in a general way by the concepts of state and space.

Situation awareness modeling is generally used in the command and control domain for situation assessment and decision support. It is based on the Endsley's three-layer structure (Endsley, 1995), but with the addition of a terrain model for the command and control domain.

Incoming data is first represented at the Perception layer (level 1) of the situation model. The Comprehension layer (level 2) then interprets the data and provides an assessment of the current situation. To support anticipatory decision-making, the Projection layer (level 3) predicts future states based on the understanding of the current situation. At present, only some basic projection functions have been implemented for illustration purpose. All three layers of the situation awareness model function concurrently and iteratively.

For an end-user application, this model is the most suitable representation. It combines the advantages of most representations. LLA uses a situation-aware model using the key-value model to match context to services, markup scheme model to textually describe situations, logic models to build Event-Condition-Action approach as a global workflow and graphical models to represent and understand situations semantically. This modeling is a paradigm used by context-aware platforms in order to build their vision of context-aware applications.

### **3.3. Platforms dedicated to generating context-aware applications**

In this scope, many works provide a way to automatically generate context-aware applications for users. These platforms are based on the studied contextual models and approaches. Each of them has its own vision and features for the produced applications. On this study, we focus mainly on mobile applications and services (see Figure 18).

CyberDesk [27] is a component-based framework written in Java that supports the automatic integration of software applications. This framework is flexible and can be easily customized and extended. In CyberDesk, components treat all data, in the same way regardless of the source (PC, PDA, Phone, etc.).

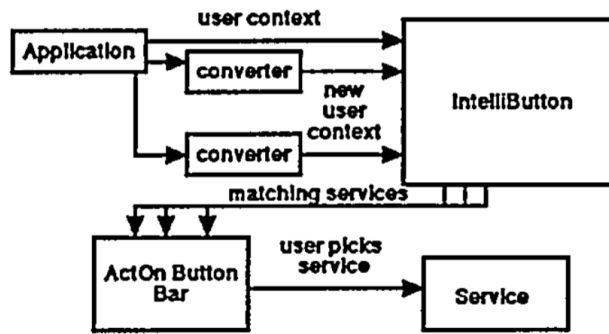

Figure 18 – Cyberdesk’s runtime architecture diagram [27]

CyberDesk’s user applications provide automatically their services to the user by an intelligent interface. It displays, selectively, services that are relevant to the user’s context instead of overloading him/her with unnecessary services. The context, in CyberDesk, includes a wide range of data like the time of day, the user’s physical location, emotional state, social environment, objects in the room, etc. CyberDesk is capable of working with this information regardless of the device.

CAreDroid [30] is a framework dedicated exclusively to Android applications. It produces context-aware applications by setting up an easy development process that separates functionality, mapping, and monitoring and by integrating context adaptation into the runtime. In CAreDroid, context-aware methods are defined in application source code, the mapping of methods to context is defined in configuration files, and context-monitoring and method replacement are performed by the runtime system (see Figure 19).

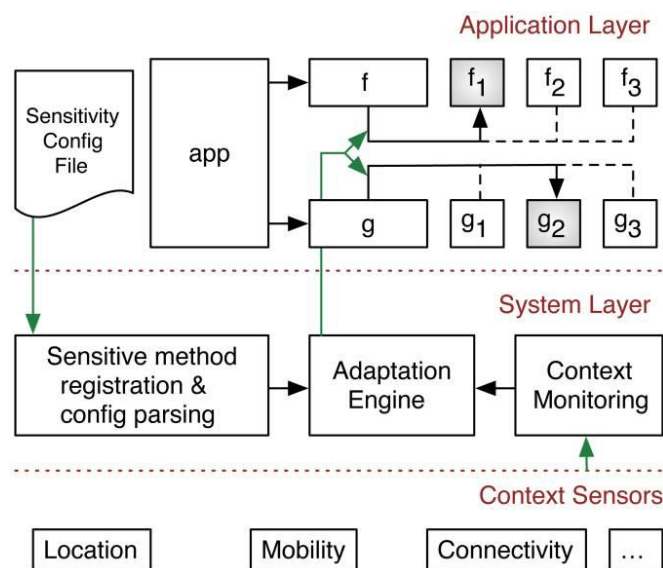

Figure 19 - Care droid's architecture [30]

In order to reduce code volume, applications using CAreDroid do not directly monitor or handle changes in context. CAreDroid introduces context-monitoring at the system level so it avoids the overhead of reading sensor data in the application layer. This approach makes context-aware applications more efficient.

WildCAT [25] system is a lightweight, general and powerful Context-Awareness Java-based Toolkit. It provides a simple API to discover, reason about and be notified of events occurring in their execution context, represented in Figure 20, which makes creating context-aware applications relatively easier to Java developers. It enables the sharing of the low-level code to gather information about the context, in order to reflect the code reuse practice and offer comfort and time gain for application programmers.

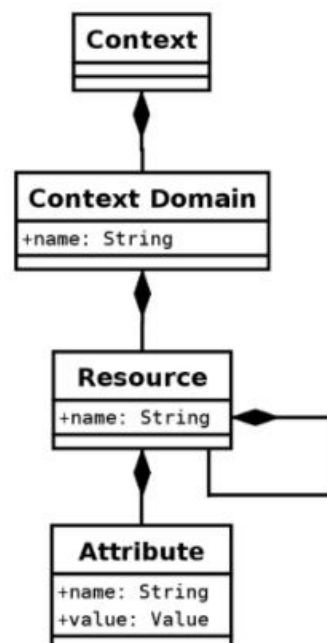

Figure 20 - WildCAT's logical model [25]

WildCAT was created as a part of SAFRAN [52], an extension of the Fractal component model [83] for the creation of self-adaptive applications. It provides a simple interface for programmers to make their applications context-aware, without imposing too many restrictions on the actual implementation of sensors in order to enable the integration of many different kinds of context information like local hardware probes or sensor networks. Although WildCat is a simple to use tool that could be used and integrated easily, it does not introduce groundbreaking ideas regarding context awareness.



## 4. User-centered Context-aware mobile applications

The final goal of our work is proposing an end-user context-aware dynamic context-aware application. After studying all the areas that lead to build and run this kind of applications, we present now both commercial and research applications providing the wanted features for common usage on mobile devices. In the following, we present a set of existing application that provides similar features to what we want to achieve.

### 4.1. Existing solutions

Google is one of the biggest companies putting an effort to aim their work in the area of dynamic applications able to detect context and offer services to their users. Their main application is called ‘Google’ [40] or ‘Google Now’. This application is triggered by contextual changes or voice commands. It detects/gathers relevant data (home location, work location, calendar events, Google+, etc.) about users and saves their Google searches using Google knowledge graph. It uses other Google services (Google Maps, Google Images, and Google Alert, etc.) to provide features like getting updates on sports, movies, and events. In a recent build, Google fully integrated Google Now and combined it with an AI into the Android layer of their first smartphone (Google Pixel). Google also took other interesting initiatives with context-aware applications but in a different format with Google Instant Apps [41, 57]. They offer the possibility for developers to decompose their applications into smaller apps dedicated to specific needs and triggered by, either clicking on a link from the web or by NFC (example: to buy an item on Amazon, the user reaches the item on Google and then when he/she are about to pay, the Amazon payment instant app is launched with no installation required). The parking micro-app is only launched when the user faces the parking machine and places their phone on the machine to trigger the parking app. It uses an approach similar to Micro-apps [96]. The strength of these solutions comes from the fact that they are built on the multiple services of Google. Nonetheless, Google focuses their applications on predictive recommendations that may be interesting to the user in a limited range of situations because they only use their tools to achieve to respond (notification, alerts and Google applications) to the needs of the user.

Grokr [21] is the equivalent of Google Now for iOS focused on context-aware recommendation (predictive search engine) and notification system. It notifies for nearby events (concerts, sports events, and important occasions to the user (birthday, calendar events)). These services are also integrated into applications like Osito [22] and Tempo [97] but with a slight



difference in the way that they are presented and in the mechanisms behind them. The Grokr advantage over Google Now by being able to pull information about the user from social graphs (Facebook, Twitter, LinkedIn, and Google+) while Google links only with Google+. The drawback of this application is that the same as Google Now, it has limited services and doesn't allow flexibility when inputting context.

Easily Do [94], 24me [1] and Tempo [97] are all personal assistants solution to productivity planning and scheduling. Tempo is based on an AI able to pull user contextual information and predict meeting places and attendees. 24me integrates the user's calendar, tasks, notes and personal accounts together in order to customize the application and have automated reminders about paying bills, sending gifts and going to doctor appointments etc. The problem of these application comes from the limitations of AI (redundancy of recommendations, lack of dynamicity, get the control out of the user's hands etc.) and lack of diversity of their services (notifications, recommendations etc.).

IFTTT [80] is another interesting solution. It considers the user domain (devices) and exploits it by using web services able to communicate, link and control remote devices (connected lamps). Although its contextual model is poor, it offers pertinent useful scenarios (turn on lights automatically at 7 pm). Therefore, IFTTT is dependent on those services and is repetitive and not really aware of the user's situations.

The applications, presented so far, are commercial apps created by companies. Now, our focus is on research works tackling this area.

SECE [79] (Sense Everything, Control Everything) is an application for context-aware service composition offering a rule-based approach in a more user-friendly way enabling users to define the expected behavior of a set of web-based services under certain situations. These situations are used to trigger the composed service execution. They are based on basic contextual information like location, time. Even though it is user-friendly, inputting rules in a written manner is always considered a boring task to mobile end-users.

DoTT [44] is another rules-based system using context providers in order to be aware of the user situations instantly. It is built over a reasoning engine able to comprehend the adaptation rules and react to the user's context changes following those rules. As output, it has an interactive interface that can host the services provided by the system. The difference between this approach and other rule-based systems is that the rules in this work are presented in a natural language following a specific grammar (sentences). The drawback of this work is the limit of its basic services (messaging, calls, calendar and social).

Dig-Event [111] is a mashup service that allows the users to define and order activities like trips and meetings by providing them with recommendations of a diversity of relevant services for performing those activities. The service recommendations rely on context-based selection criteria including time, type of activity, budget, etc. Nevertheless, this system lacks flexibility in context acquiring. In this work, the user context is the result of the manually entered information when declaring the activity but it doesn't consider context changes when doing that activity.

The last type of context-aware applications is called trail-based applications [18]. A trail is a contextually scheduled collection of activities and represents a generic model that can be used to satisfy the activity management requirements of a wide range of context-based time management applications. Combining the trails concept with mobile, context-aware technology creates opportunities for innovative activity-based application development. Hermes [19] is a software framework for mobile, context-aware trails-based applications which will support developers by providing generic components containing structure and behavior common to all trails-based applications. It organizes, using a mathematical model, the activities of the user according to his/her previous trails. The problem with this approach is that it is too much focused on travel scenarios rather than everyday situations that can be indoors.

Table 4 compares the existing works to our proposal (LLA) based on different criteria: contextual model variables, the existence of context detection mechanism and its type (distributed or centralized on one device), whether contextual growth is considered and what are the sources of that growth, services offered and finally the ubiquity of the offered services.

**Table 4: Comparing context-aware end-user applications**

<b>Application</b>	<b>Context</b>	<b>Context detection/Type</b>	<b>Contextual growth/Sources</b>	<b>Services</b>	<b>Ubiquitous response</b>
Google Now	Search history, location, calendar, emails	Yes/Distributed	No/None	Alerts, Notifications, recommendations, Google services	No
Google Instant Apps	NFC, link	Yes/Distributed	No/None	Instant apps	Yes
Grokr	Search history, location, social accounts	Yes/Centralized	No/None	Alerts, Notifications, recommendations	No
Osito	Location, calendar, emails	Yes/Centralized	No/None	Alerts, updates	No
Tempo	Calendar, Location, Contact list	Yes/Centralized	No/None	Notifications, Context prediction	No
24me	Calendar, tasks, notes, social accounts	Yes/Centralized	Yes/User	Reminders	No
Easily Do	Location, time, calendar, communication events	Yes/Centralized	Yes/User	Mobile services	Yes
DoTT	Location, time, communication events	Yes/Centralized	Yes/User	Call, Messaging, social, calendar management	No
Dig Event	Location, time, activity, budget, presence	No/None	Yes/User	Widgets	No
IFTTT	Information provided by the web service	Yes/Distributed	No/None	Web services	Yes
SECE	Calendar, time, location, presence	Yes/Centralized	Yes/User	Email, message, call	No
Hermes	Activity, locations, previous trails	Yes/Distributed	No	Optimized activity scheduling	No
LLA	Time, location, activity, Time*Location, Time*Activity, Location*Activity	Yes/Distributed	Yes/User, Social, External providers (Government, Businesses, SHERLOCK)	Kalimucho components, Composed services	Yes

## 4.2. Discussion

To summarize, our proposal called Long Life Applications is anchored in the center of context-aware mobile applications. Our novel contribution is mainly focused on the contextual situation injection (Contextual growth), the modularity and the ubiquity of our proposal. Although some works consider injecting context (by rules, natural language or voice commands), they only consider the user for this task. Our work proposes a richer injection mechanism (see Chapter 7) that allows the user to have a more diverse experience and offers him/her more freedom without having to rely on any programming skills (opposed to traditional rule-based systems). Furthermore, the services offered by our proposal are limitless due to the fact that they are related specifically to the situations. It means these services are specified by the creator of the situation. Finally, our application is pervasive and built on a modular architecture able to run simultaneously on many devices regardless of their capabilities, OS or network.

## 5. Conclusion

Context-aware applications have been the topic of discussion for more than a decade and are still being studied by a lot of researchers. Each of them presented their own views, brought their own contributions and built their own solutions. The depth of this area stems from the diversity of proposals and richness of factors to take into account when trying to offer the needed solution that reflects the expectancies of the usage of this kind of applications.

Proposing a new kind of mobile applications for the future requires having a full understanding of the state of art related mainly to the expectancies of the users and to the technological advancements. Therefore we propose to incorporate context awareness to regain the interest of users in mobile applications by proposing a fluid, dynamic application able to understand their needs and evolve accordingly. We consider also the technological advances by proposing to incorporate the distribution aspect into their applications in order to take advantage of the ubiquity and computing power of the new coming smart connected age of technology.

In summary, in this chapter, we presented a thorough study of the areas surrounding our work. We believed necessary to tackle this domain from its most important aspects that lay the grounds to present our proposal.

---

---

*Chapter 3 Long Life Application Proposal*

---

## 1. Introduction

With so many possible use cases and such diverse user needs, is it desirable to have one application that does it all? Has it become a necessity to have one application able to understand users and eliminate the need for other applications? In order to answer these questions, we first need to clearly define Long Life Application.

LLA is a context-aware distributed mobile application dedicated to everyday users. It offers modular mobile services to the consumers of mobile applications that, until now, search, find, install, update and delete their applications on their devices. This kind of applications is called long-life Applications (or Eternal Applications) as it runs constantly and evolves by changing its behavior and offering a variety of services according to the user's needs.

Our vision of this application is centered on one user in his connected environment, that we call user-domain, making it a distributed mobile application by definition. This app needs to offer to the users a high level of comfort and a better-customized user experience by replying both re-actively and pro-actively to the users' needs without confusing them by the large diversity of apps and devices.

This app needs to be contextually aware of the users and their surroundings giving them the opportunity to be operationally connected entities in their future smart world. In our proposal, the context awareness manifests in situations that represent the current context of the user. These situations are the main entity of our application. They can represent the user's everyday life according to his contextual information (see Chapter 4 and 5).

After understanding the user's situation, the application offers the appropriate services that can answer to his need in the best dynamic distributed way. It deploys/migrates software components on the devices of his smart-domain (his devices) and then deletes them when no longer needed.

Nonetheless, no application can neither predict nor autonomously handle all the possible situations that could happen to the user in all different areas (shopping, work, travel, etc.) due to the infinite possibilities. Therefore, our proposal allows to dynamically add new situations, from both non-experts (e.g. everyday users) and domain experts (e.g. travel agent), into the user's application (see Chapter 7).

In order to achieve these goals, we present in this chapter an overview of the proposed approach and how it answers the raised issues with existing solutions (see Chapter 2). In this

chapter, we also present the novelties and contributions of this proposal in regards to the area of mobile applications dedicated to everyday usage.

## 2. Approach Overview

LLA, as we define it in [59], is basically a transparent application that starts once and continuously (long life) monitors the user's context in order to offer him/her the appropriate services ( a group of software components connected to each other) when needed and on the appropriate device. It changes the classical approach where the user looks for the applications and instead it makes the services come to the user. Therefore, LLA has to be context-aware and distributed on the devices of the user.

In order to offer context awareness, the application needs to be able to detect the context of the user and react accordingly. Hence, the first step would be to collect information about the user and feed it to our application as an input. The application is based on a modular architecture (framework) that is able to detect, understand, and react by offering services related to the users' needs (see Figure 22).

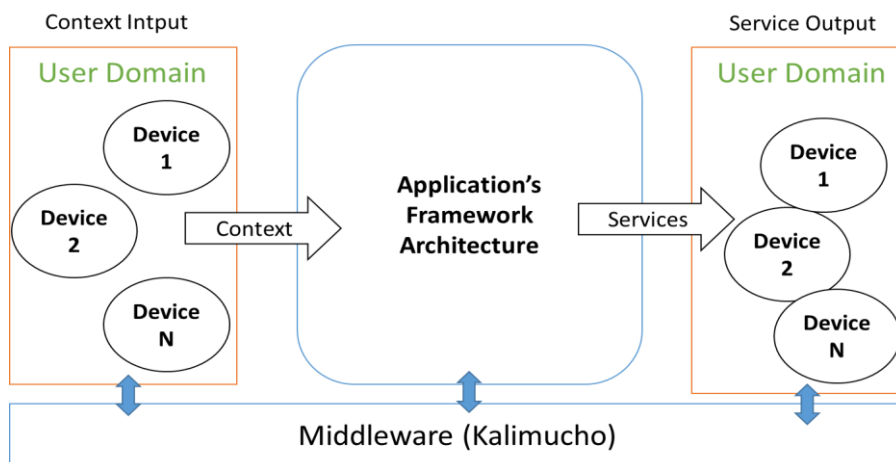

Figure 22 - LLA PROPOSAL OVERVIEW

The architecture that we propose answers to the most critical challenges surrounding contextual awareness in user-centered everyday applications as well as the distribution aspects for this kind of applications (see Chapter 2).

The main components of this proposal are the user-domain, the context collectors, the service output, the middleware, and finally the main core of the application. All these components are built using the Kalimucho [23] middleware in order to manage the distribution aspect of our

proposal. From the user's perspective, the visible part of LLA (front -end) is only the deployed services, the device possesses a screen, LLA provides (in addition to the deployed service) a management UI that allows the user to manage the application (configurations) and use its features. The rest of the components are completely transparent (back-end) but keep running continuously so they can provide the user with the required services.

The general process of LLA starts by extracting contextual information from the user-domain and then inputting it into the core architecture in order to animate it. Inside the core of our proposal, we implement a process respecting the Event Condition Action (ECA) approach [76, 9]. When fed to the core, this contextual information helps to construct an event, to verify if conditions surrounding that event are met and to, finally, deploy services as an action for that event. Through this process, the contextual information respects a defined situation-based contextual model that structures and represents the data extracted from the devices in order to build an entity (Situation), which can be understood by both the application and the users.

After defining the main components of our proposal and describing the workflow process, we evaluate this proposal by comparison to existing solutions. This comparison (see Table 2, 3, and 4) shows that our solution improves on the limitation of existing applications by providing a number of novel contributions on the theoretical and technical level. These contributions are the solutions to the issues raised by the studied works.

### **3. Contributions**

In the studied works, some issues appear to be common between these context-aware distributed applications. These issues are of course related firstly to the awareness of the application and secondly to the distribution aspects.

#### **3.1. A rich and user-friendly contextual model**

When dealing with context, one of the aspects that developers and researchers have to consider is creating a contextual model that can be, on one hand, rich enough to express very specific and detailed situations, and on the other hand, simple enough for users to comprehend (user-friendly). Therefore, we present a user-friendly (for a non-expert), rich (for experts), extendable, and situation-based contextual model [60, 61].

The context of LLA, as we defined it, is a variety of situations that occur to the user while he/she evolves in his/her environment. The totality of these situations shapes the user's



application. The main entity, called Situation, is the element defining the application's behavior. This model will define the rules of our representation of the user's context and our answer for context management challenge.

The situation, presented in chapter 4, in our system is the key component. It combines the best benefits of the context representation models studied in chapter 2. It is an overlapping between schema markup, graphical and logic models. We use scheme markup to textually write these situations so they can be analyzed and parsed by the different modules of the application. The graphical aspects of our model are reflected through the representation of the situations in a multidimensional coordinate system with limits and restrictions. Last but not least, this model follows rules that match the situations to services and reaction strategies.

In chapter 4, our proposed model is described thoroughly by presenting its main constituents and by showing examples that illustrate the way that users and experts can easily exploit this model to represent their needs.

### **3.2. A cross-device context detection**

Context-awareness requires, by definition, a system able to detect the context and understand it. An important drawback of existing applications comes from identifying the user with one and only one device. These applications limit their detection on the user's mobile phone. This issue motivated our work to be oriented to cross-device context detection dedicated to end-users and enabling the application to accurately follow and detect context changes.

LLA allows the user to properly use his/her soon-coming smart environment (composed by his/her own computing devices and other surrounding devices in the Internet of Things) without any confusion due to the multiplicity of devices and the heterogeneity of systems available. For that purpose, we re-think the architecture of traditional applications, dedicated to stand-alone devices, and aim towards liquid applications [6, 100] by implementing a distributed context detection mechanism [78] able to continuously query the user's devices for the contextual data needed in order to detect and evaluate his/her current context.

This mechanism presents advantages for monitoring contextual changes from every angle by incorporating an innovative cross-device context detection in order to draw the bigger picture of the user's context. This support for multiple devices enhances the capability to detect situations, anywhere and anytime, as data captured from different devices and sensors can be

combined. Besides, it is a suitable solution for the common case of a user with multiple devices, as he/she is not obliged to manage only one specific device.

### **3.3. A modular orchestration of services**

In the middle of this rapidly increasing connected world, users will be faced with a huge overhead to manage their devices. Besides managing these devices, users are looking forward to having a rich user experience that spans on multiple terminals making him/her feel as the center of his/her environment.

Existing context-aware applications that consider distribution propose only generic services that run specifically if a set of sensors and/or devices is present and fully functional. For example, YouTube has distribution features that allow the user to project the videos on his/her TV. Nonetheless, that requires having a Chromecast [107] device connected to the TV. Moreover, the use cases of the distribution aspects are limited to streaming or sending simple data between devices. This is due to the fact that current mobile applications are installed as an enclosed runnable bundle (.apk, .ipa, .cab, .ipk, etc.) that contains all the compiled code base which makes the modules of that application tightly-coupled.

In our work, we use a different more flexible approach. We consider a service as a set of atomic, independent and connected mobile components able to run, stop, migrate, and communicate with each other.

The benefit of this approach is the number of possibilities of different user experiences that the application will provide for the user. By decomposing the services into software components, LLA is able to target the deployment of these components to the best fitting device that possesses the hardware capabilities required to run these components in an optimal and useful way. Moreover, this approach ensures the continuity, sustainability, and scalability of the application by being able to move components freely between devices at run-time if the host is for example overwhelmed with the component processing requirements or if it has a low battery level and about to go offline soon.

### **3.4. A collaborative situation injection**

From a mobile application's point of view, what users expect is an application that understands what they expect and most importantly application that is dynamic and non-repetitive. Therefore, we propose a semi-automatic collaborative injection mechanism to ensure

the growth of the user's application in order to continuously provide the user with richer contextual awareness, better-adapted user experience, and more adequate services. The real motivation behind this mechanism is to overcome one of the most common limitations of context-aware applications. This limitation is their dependence on knowledge about a certain domain (hospitals, museums, supermarkets, etc.). This knowledge is usually provided by those domains experts to the researchers or developers in order to build their applications rules and/or ontologies that represent that specific knowledge base. This makes these applications consider a limited area of expertise with limited pre-defined use cases and generic services.

LLA breaks that limitation by externalizing the definition of situations to enable the experts of those domains to input their descriptions of their users' needs following our situation contextual model and providing the most fitting services for those needs.

Mainly, the injection mechanism [62] enables the application to keep evolving and be customized exactly to what the user's needs, likes and does. Using this approach, the application is able to always enrich the user experience by adding, deleting or modifying the users' situations. This mechanism (see Chapter 7) is based on our user-friendly situation model in order to make the injection an easy and understandable mechanism that can be performed even by end users with no understanding of context awareness. Consequently, the collaborative injection makes context detection richer, more accurate and user-centered by giving him/her the possibility to create his/her own situations or extract them automatically from his/her social environment (Facebook, Calendar, Twitter, etc.). The user can also receive nation-wide situations provided by the government (e.g., closing borders, hurricane alerts, and elections). Moreover, he/she trust external developers, companies or businesses (shopping centers, suppliers, restaurants, etc.) to inject new situations.

#### **4. Application's General Architecture**

After defining the overall approach and the main contributions of this work, we introduce, in this section, the global architecture of LLA. This architecture displays, in a general presentation, the main modules constituting the application and running in the background (back-end). Accordingly, these modules reflect and respect the claimed contributions.

Due to the distribution requirements of this kind of application, all the building blocks (modules, components, files, etc.) are dynamic, functionally independent, and controlled by Kalimucho middleware. This aspect ensures the continuity of the application in case one of the

core components faces some issues while running. In Figure 23, we present the global core architecture of our back-end application.

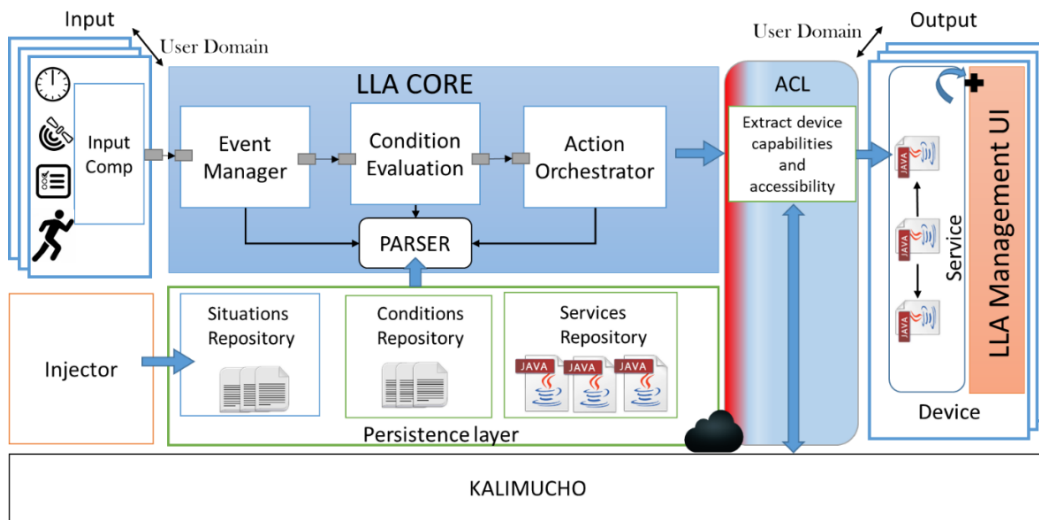

Figure 23 - LLA's General Architecture

As described in Section 2, the process of the application starts by collecting contextual information from different devices (user domain) as input, evaluates this data, determines the current situation of the user, and ends by providing a distributed component-based output.

Each module of this architecture has its own internal architecture and workflow. They interact with each other by exchanging data on runtime. Once started, these modules are deployed on the user's devices following a defined distribution strategy (see Section 5). After that, they keep running continuously (thus the term "Long Life") in order to go together with the user in his/her fast changing everyday context and react accordingly.

#### 4.1. The User Domain

The User-Domain is used to collect data for building contextual situations and host the adequate services. This concept defines the list of the user's **available** devices that **host** an instance of LLA and which are **accessible** to the user.

- **Hosting LLA:** The device needs to have LLA installed on an Operating System (OS) able to run the Java Virtual Machine (JVM). This requirement does not mean that the application will run entirely (in the same way) on all the devices. The deployment strategy of the application (see Section 5) organizes the modules

between the devices that have an instance of LLA. This solves the issue of duplication of current mobile applications on users' devices.

- **Availability:** In order for the application to function properly on these devices, it needs to recognize the other devices. This means that when the user wishes to use the application the device should be turned on, connected to any network (Wi-Fi, 3G, 4G, Wired-networks, etc.) and allowing data-exchange on those networks.
- **Accessibility:** In LLA we define two types of accessibility level in order to organize the user-domain, avoid confusion between the devices of different users and ensure the security of the user and the protection of his/her data (see Figure 24). The user has the possibility to fully manage the devices surrounding him/her. Using the LLA Management UI, he/she can add new devices, delete existing devices, monitor connected devices, modify accessibility and configure security preferences.

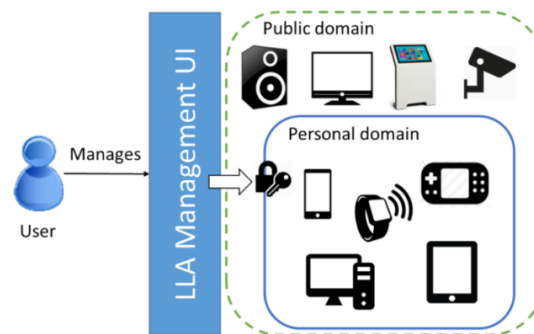

Figure 24 - User's domains

- **The Private Domain:** This level of accessibility represents the user's own personal devices that are accessible only to him/her. This means that no other user is able to extract data from or deploy component on those devices. In order to securely use this domain, the user defines a Shared Secure Key (SSK) between all his/her private devices in order to have a closed and protected domain.
- **The Public Domain:** These devices are accessible to any user at any time. The motivation of adding this layer comes from the multiplicity and availability of this kind of public devices everywhere (e.g. airports, bus stations, hospitals, etc.). Nonetheless, these terminals are solely used to deploy services. It makes no sense to extract contextual data from these devices since they do not represent the personal context of the user (except the location).

The User-Domain enables LLA to keep the user's devices organized and categorized. In respect to the stated contributions (3 and 4), the User-Domain helps LLA to clearly identify the devices, surrounding its user, in order to properly extract relevant context and optimally run the expected services.

## **4.2. Kalimucho**

In order to manage the devices in the user-domain, LLA needs to use software components able to communicate regardless of the differences between these devices. Thus comes the need to use a middleware offering a component model suitable for the requirements of LLA (see Chapter 2).

## **4.3. Input**

The first step of detecting context is extracting relevant data from the user's devices. Therefore, we introduce on the input level a cross-device contextual data extraction. This mechanism, continuously and optimally, provides LLA with pertinent information about the current context of the user from multiple sources (User Private Domain) simultaneously. It is the starting point of the workflow.

The data extracted on this level is used to verify the occurrence of the user's situations respecting the situation-based contextual model defined in Chapter 4.

## **4.4. Output**

The goal of context awareness is to offer adequate services when the right context is verified. Therefore the final output of LLA (front-end and/or back-end) are the services that it deploys/stops/migrates in response to detecting a situation.

Consequently, the services are a group (or single) of Kalimucho components (see Chapter 6) able to run, communicate, stop, and migrate to any device on the domain. If the output requires running/stopping a new component, that component could be either ran/stopped on the background (with no UI) or added to/removed from the main LLA management UI (with UI). Migrating components is the process that can be done manually by the user or automatically by the app if the quality of service (QoS) is not ensured. It combines stopping the component on the one device and running it on the other while keeping its status.

## **4.5. The Injector**

The Injector is a mechanism (see Chapter 7) that allows a collaborative dynamic injection of new high-level context (situations described using the proposed situation-based contextual model) into the user's LLA [62].

The main novelty of this mechanism is a cooperative workflow that enables users and other external sources to continuously and pro-actively contribute to the growth of the user's application, in order to improve its understanding and reliability and overcome the lack of dynamicity in current context-aware applications, which causes that only 25 percent of users return to any given application after the first use [3].

Our proposal for situation injection and detection is a hybrid approach that combines both high-level context (top-down approach), by injecting user-related context, and low-level context (bottom-up approach), by inferring it from sensor data.

## **4.6. The Persistence layer**

The persistence layer is a cloud and local storage dedicated to storing data about the user (situations, conditions, mapping, Kalimucho components, and services descriptions). Each device has a local persistence layer that communicates and synchronizes with his/her private cloud storage.

## **4.7. The LLA Core**

LLA's core represents the application's engine. It is based on an Event-Condition-Action [76, 110] approach. This approach is adequate to context-aware applications due to its reactivity and ability to adapt to changing conditions.

The core is the center of our proposal. It receives data from the input, deploys services as an output and communicates with the user's persistence layer.

### **4.7.1. The Parser**

Communicating with the persistence layer requires a module able to parse and construct data into the appropriate situation-based format. This module acts as a monitor and manager for the files in the persistence layer. It notifies LLA if there are any changes in those files. This optimizes the access time and the efficiency of the overall application.

#### **4.7.2. The Event Manager (EM)**

The Event Manager is in charge of receiving the input of current relevant contextual data (e.g. time, location and activity) from different devices, scanning the situations repository in order to find out if the received data triggers a new situation or ends an existing one. Triggered and ending situations are transferred to the next module (Condition Evaluator).

#### **4.7.3. The Condition Evaluator (CE)**

The Condition Evaluator evaluates the conditions, limitations and the priority levels between situations. The CE receives, from the EM, the list of ending and starting situations and filters them by verifying whether they violate any user limitation and by calculating their priority levels.

#### **4.7.4. The Action Orchestrator (AO)**

The Action Orchestrator is the module that will respond to the situations using the available services and devices by consulting the device filter. It orchestrates the deployment of those services following an optimal deployment strategy in regards to the capabilities of the available devices.

It also keeps track of the currently happening situations so it can be able to stop them when they are no longer needed by sending the appropriate commands to the Kalimucho platform in order to run or stop any service in the user's domain through the ACL filter.

### **4.8. The ACL filter**

This layer is a filter mechanism based on the Access Control Lists (ACL) approach [90]. It helps the AO to get information (hardware capabilities, processing power, memory usage, etc.) about available devices in the network considering their accessibility. It handles the user-domain and secures the transference of data between them and hides devices from non-authorized access.

After passing through the Condition Evaluator, Action Orchestrator and Access Control Lists (ACL), the application sends commands to the Kalimucho platform in order to launch or remove the appropriate components.



## 5. Application's global workflow and distribution strategy

Due to the distributed nature of LLA, the key modules defined in LLA's architecture should respect a distribution strategy in order to exploit the user's environment and keep the continuity, relevance, and sustainability of the application. Figure 25 shows the status of the application across four different devices.

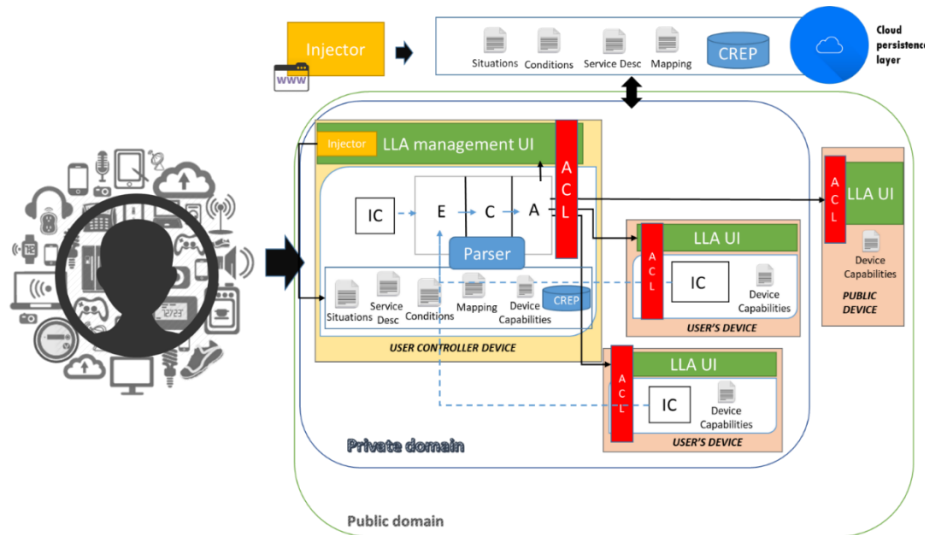

Figure 25 - LLA running across devices

The strategy and workflow illustrate the stated contributions. They allow the cross-device context detection, the collaborative contextual injection and the modularity of services. Therefore, clear definitions of the workflow and the distribution strategy are needed.

### 5.1. The deployment strategy of LLA

The deployment strategy is the plan that organizes how, when, and where the key modules of LLA (Input, EM, CE, AO, ACL, and Injector) must be deployed. It ensures mainly that the application is well-aware of the user-domain and that there is neither redundancy nor concurrency between the modules of LLA.

When the user starts the application on any of his/her devices, the LLA management UI (front-end), the ACL and Input modules (back-end) are always launched first. After that, two scenarios could occur (see Figure 26).

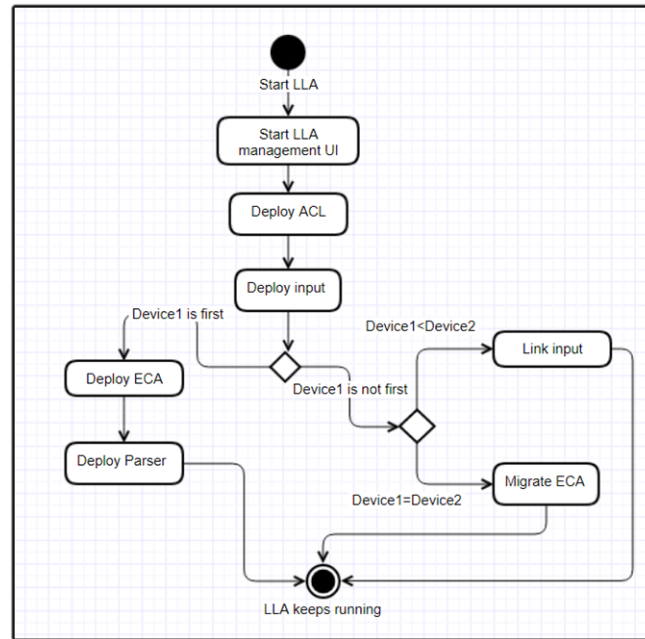

**Figure 26 - Deployment strategy for starting LLA**

The first scenario happens if that device is the first device (Device 1), which is private, available on the network and meets the requirements (see Section 4.1), that started LLA. This means that no other device (Device 2) has an instance of LLA already running. In this case, LLA deploys all the modules on Device 1. Device 1 becomes, for now, the user's controller device. After that, this device keeps running LLA and monitoring the user's domain for new devices to join in.

The second scenario happens when the device is not the first one to start LLA. This means that when the user starts the application on this device (Device 1), there is another instance of LLA already running on another device (Device 2). In this case, two things can happen. If Device 1 has better hardware capabilities than Device 2 ( $\text{Device 1} > \text{Device 2}$ ), LLA migrates the architecture, already running on Device 2, to Device 1. Otherwise, Device 1 links its Input to the EM of Device 2.

When stopping (see Figure 27) the application on one device, LLA verifies if that device hosts the whole architecture (ECA) and asks the user whether he/she wants to fully stop the application on all devices or just on this one. If the user chooses to stop it just on that device the architecture is migrated to the best available device and reconnects the inputs from the rest of the devices. In case the architecture is hosted on another device, LLA simply stops on that device by stopping the ACL and the Input making that device unavailable for the User's Domain.

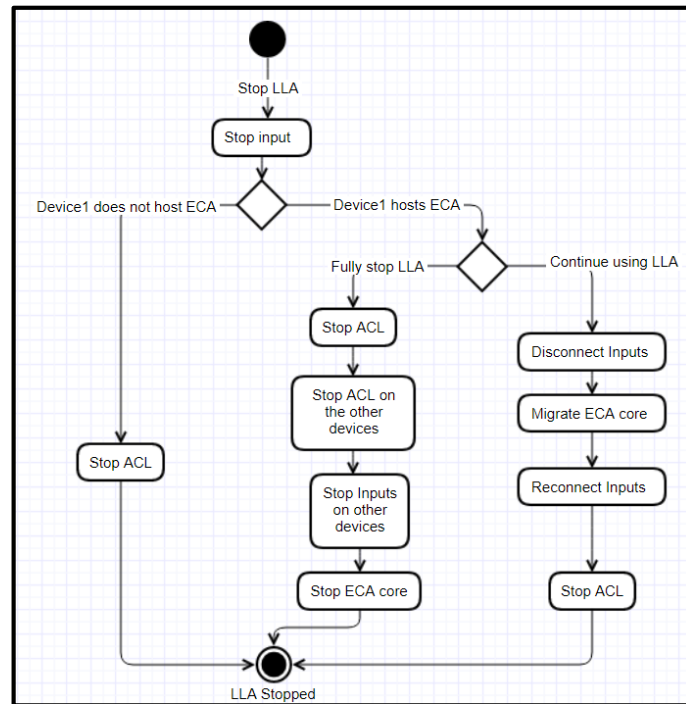

Figure 27 - Deployment strategy for stopping LLA

## 5.2. The workflow of LLA

LLA is the application that replaces all the other existing applications by assisting the user continuously. Therefore, after all, modules are running (on one or multiple devices), LLA keeps running in the background until the user chooses to stop it manually.

When LLA is newly installed on a device, the user chooses (using LLA management UI) the Shared Secure Key (see Section 4.1). This key will allow LLA to join that device to the user's Private Domain. The user could also choose to offer that device as a public device that could be used by other users.

When LLA starts, the Parser extracts the situations from the user's Persistence Layer in order to start evaluating them according to the detected contextual data. The Parser is also used to synchronize with the Persistence Cloud Layer and refresh the situation repository in case of any new changes (coming from the Injector).

Once running, LLA's workflow starts by monitoring the user's context. To do so, the distributed Inputs keep feeding the ECA core with relevant information about the user. Specifically, every time that one of the Input modules send data to the EM, the ECA core evaluates the situations in order to determine the ones about to start and the one about to end.

If LLA needs to start a new service to respond to a newly detected situation, the AO looks for the needed service and deploys it on the best fit devices available. LLA looks for the services (a group of executable jar files) first in the Local Service Repository (LSR), then on the LSR of other available devices, and finally on the Cloud Service Repository (CSR) (see Figure 25). Once it finds the needed services, the AO consults the ACL filter about the accessibility and capabilities of the available devices on the network in order to run those services on the most adequate devices. If the services have a visible UI, they are added to the LLA management UI of their respective devices. Otherwise, they run on the background of those devices.

Ending situations trigger the opposite process. When LLA detects the end of a situation, which is already active, it looks for the services that are related to that situation in order to stop them on their respective devices. Stopping those services stops consequently the components by removing their UI from the LLA UI or simply stopping them transparently if they run in the background.

## 6. Conclusions

When dealing with context-aware distributed mobile applications, the challenges are multiple and the solutions are different. In our proposal, we tackled those problems by presenting the idea of LLA.

To summarize, LLA is a modular distributed mobile application that spans across a network of connected devices in order to understand its user's context and provide him/her with the most adequate services while offering an open user experience that could be enriched continuously. Following the distribution strategy and workflow, LLA is able to work harmoniously on the user-domain and changes the way that he/she interacts with his/her applications, devices, and overall experience.

LLA modules, interactions, rules, strategies, and mechanisms embody the stated contributions. These contributions are the solutions to the limitations of current mobile applications. Therefore, the next chapters are dedicated to showing a detailed presentation of the modules constituting LLA. These modules are all composed of sub-modules, components, and mechanisms that reflect our contributions and the behavior of the application.

The next chapter is dedicated to present the first contribution of this work. It focused on the modeling aspects of situation-based context.

---

---

*Chapter 4 Situation-based contextual model*

---

## 1. Introduction

The fundamental objective of context-awareness is to provide services not only to people at any time, anywhere, with any media but specifically to communicate the right thing at the right time in the right way [53]. To achieve this, applications should be aware of their context [48, 49, 74].

All context-aware applications have their own ideas, methods, and techniques to represent and understand the user's context. The common factor between all of them is that they all follow the same patterns. They, first, select the type and source of relevant data needed to build the context of the user. They categorize and normalize that data. They build their rules/representations/models which will later be used to evaluate and react to the user's current context.

All things considered, the context representation is the first step and the determining factor in how context-aware applications react to changes and adapt to the user's needs. In LLA, it is crucial to be aware of the user's behavior and the environment surrounding him/her. Consequently, LLA needs a contextual representation model centered on the user and considering his/her needs in all circumstances.

When LLA succeeds in obtaining the data it needs at the time it needs them, the challenge of extracting actionable intelligence out of that raw data appears. We need to find a simple way to extract useful knowledge out of basic data, so as to construct different contexts of usage for the application to react. Defining the context rules and the associated actions is our main goal. The main question is whether this should be automatically learned by the system (based on the user's actions) or specified by the user by using a rule-and-action language.

Our focus is offering a user-friendly, understandable, concise yet open model able describe the daily needs of users over multiple scenarios.

## 2. Situation-based contextual model

Situation awareness is commonly defined as the perception of environmental elements with respect to time or space, the comprehension of their meaning, and the projection of their future behavior (e.g. Endsley, 1988, 1995).

The *situation* is the key component in our system [78]. According to the Cambridge dictionary, a situation is: «The set of things that are happening and the conditions that exist at a particular time and place».

- The set of things = Activity -- What are you doing?
- Time -- When?
- Location -- Where?
- Conditions = Exceptions -- What are the exceptions?

Besides, for the context-awareness to be effective, we need to answer another question to know what the user expects when this situation happens:

- Service -- What do you expect to happen?

Figure 28 represents the building blocks of the situation representation model in our application.

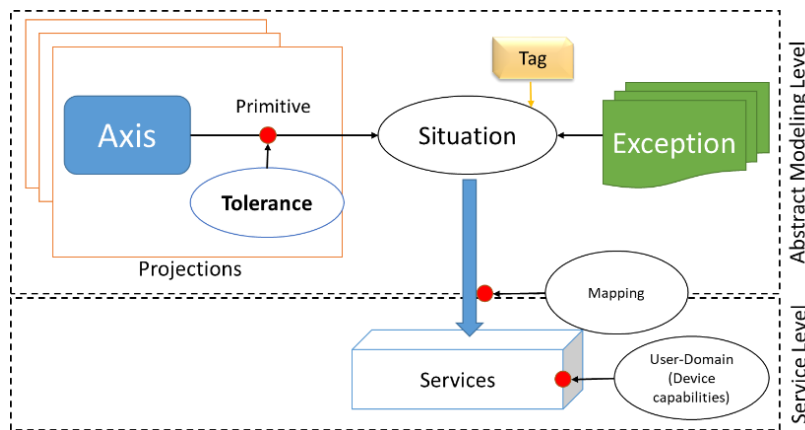

**Figure 28 - Situation representation model**

In our proposal, a situation is represented on two different levels. The first level is the abstract modeling level where the rules that build any situation are defined. The second level is the service level in which the reaction strategy to those situations is defined.

### **2.1. Abstract modeling level**

On the abstract modeling level, the situation is represented by a combination of data and concepts. A situation, in LLA, is a combination of multiple projections on different axes. Each projection is a combination of times, locations, and activities projected using binary describers (primitives). Besides, there may be exceptions, which follow the same axes and primitives. The only difference is that an exception can be another situation entirely.

Before getting into describing a situation, we need to define our key concepts and variables. The following variables are related to the axes of our situation:

### 2.1.1. Concepts

**Tag:** The tag represents the information related to the priority and source of this situation (see Chapter 6).

**Projection:** It represents the set of primitives (on axes) that combined together trigger the situation. For example, the house alarm of the user is activated if he/she is outside the house or if the time is after 10 pm. These are two different projections using different axes for the same situation (see Figure 29).

**Tolerance:** It represents the accuracy of a certain value related to the primitive. This tolerance can be interesting in scenarios where the user is not precise about his/her situations. For example, if the user wants his/her garage door to open if he/she is more or less about 10 meters from his/her house, then the tolerance, in this case, would be 10 meters related to his/her house.

**Axis:** Axes represent the dimensions of our situations (see Figure 29). For example, the time axis is one of the dimensions that can represent a situation.

**Primitive:** It is an atomic operation on a given axis (e.g., before, while, and after, for the time axis). The result of this operation is a Boolean value. For example, to represent a situation where the user is inside a location we use an inside primitive on the location axis. Tables 5, 6, 7, 8, 9, and 10 describe the primitives related to each axis. Since primitives are atomic, their output should be unique, therefore, they cannot be derived from more than two axes simultaneously. A primitive derived from three axes is the situation itself.

Table 5: Time primitives

Primitives	Parameters	Abbreviation	Description
Before	Date-Time, DTPrecision	B	Returns true if the date-time given in the parameters is before the current date-time.
After	Date-Time, DTPrecision	A	Returns true if the date-time given in the parameters is after the current date-time.
While	Date-Time, DTPrecision	W	Returns true if the date-time given in the parameters is equal to the current date-time.



Table 6: Location primitives

Primitives	Parameters	Abbreviation	Description
Inside	Location, LPrecision	I	Returns true if the user is inside a given area.
Outside	Location, LPrecision	O	Returns true if the user is outside a given area.

Table 7: Activity primitives

Primitives	Parameters	Abbreviation	Description
Free	TaskList, Activity	F	Returns true if the user is free (no tasks or activities).
PlannedTask	TaskList, Activity	PT	Returns true if the user is doing a planned task.
UnplannedTask	TaskList, Activity	UT	Returns true if the user has an opportunity to do an unplanned task.

Table 8: Time\*Activity primitives

Primitives	Parameters	Abbreviation	Description
AlmostStart	Date-Time, DTPrecision, Task	AS	Returns true if the date-time is near the start time of the task.
AlmostFinish	Date-Time, DTPrecision, Task	AF	Returns true if the date-time is near the end time of the task.
+ The rest of Time and Activity primitives combined (BF, BUT, BPT, etc.)			

Table 9: Time\*Location primitives

Primitives	Parameters	Abbreviation	Description
Closer	Location, Date-Time, DTPrecision, LPrecision, Speed	C	Returns true if the user is getting closer to a certain location in a given time frame.
Further	Location, Date-Time, DTPrecision, LPrecision, Speed	F	Returns true if the user is getting further from a certain location in a given time frame.
+ The rest of Time and Location primitives combined (BI, BO, WI, etc.)			

Table 10: Location\*Activity primitives

Primitives	Parameters	Abbreviation	Description
Opportunity	Location, LPrecision, Task	Op	Returns true if an opportunity to do a certain task in a certain location arises.
+ The rest of Location and Activity primitives combined (IF, OF, IUT, etc.)			

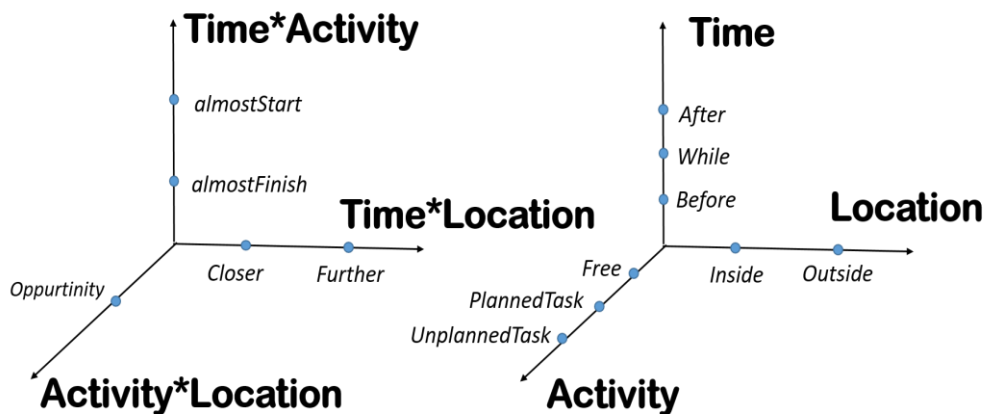

Figure 29 - Situation's projection axes

**Value:** Values are used to evaluate if the required primitives are verified (i.e., the conditions are evaluated to true) by comparing them to the current user context values (i.e., values for the time, location, etc.). For example, we consider that for the primitive After (Time axis) and the current time of the user 11 pm, if the value given to the primitive is 10 pm then the primitive returns true.

- *DTPrecision*: It is the accuracy of the time and date that will allow primitives to leave a margin of tolerance. It must be provided in the same form as the date, in order to ensure time calculations.
- *LPrecision*: It is the tolerance for the localization.
- *TaskList*: It is the schedule of the user, that contains all the tasks planned (or unplanned).
- *Date-Time*: It is the date and time value.
- *Location*: It is the physical location (coordinates, address, etc.).
- *Activity*: It is the task (meeting, sleeping, running, etc.) that the user is doing. There is no precision tolerance value for the Activity because it not a continuous axis, compared to time and location.

**Exception:** Exceptions can be related to the axes of the situation or can be represented by a whole situation. They follow a similar logic as situations, as they can be represented by (axes) primitives (see Figure 30). The difference lies in the fact that they can be represented by complete situations. This helps the application to handle multiple situations happening at the same time, by verifying if they are exceptions for each other.

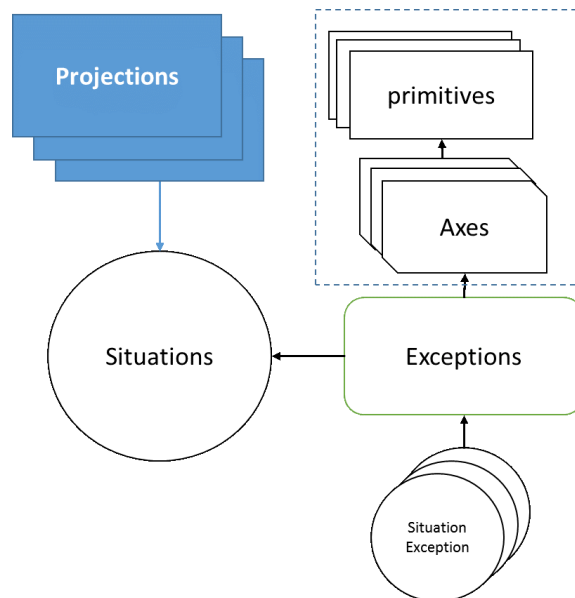

Figure 30 - Exception's representation model

For example, in an everyday scenario, we can imagine a user having a breakfast situation every day at 7 am except on Sundays.

### 2.1.2. Operations

**Combination:** Combines two concepts (projections, axes), through a logic AND operation. For example, combining two axes (Axis\*Axis) allows us to extract new primitives related to that combination. This operation applies also on primitives and exceptions. For example, if we combine Time and Location we obtain a Time\*Location axis that allows the user to express situations related to speed and relativity to a location. For example, the user can use this to express a situation that can be detected if he/she is getting closer to his/her house.

**Selection:** Acts as an OR operator (i.e., it verifies whether at least one of the variables is true). Our model uses it in order to represent a situation with multiple independent different projections or multiple different exceptions. For example, considering an aged user, the doctor can create a situation that sends him an alert when the user comes to his/her medical weekly check-up OR if he/she runs out of medication.

### 2.1.3. Situations families

**First-level Situations:** In this level, the most basic and general situations, that involve only one of the axes are represented (see Figure 31).

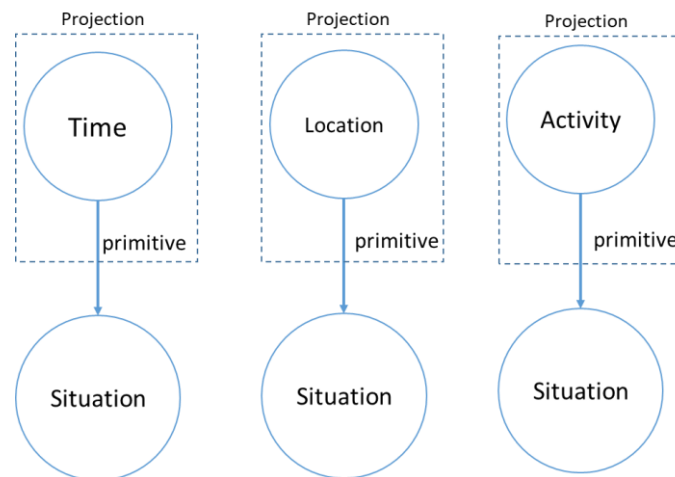

Figure 31 - First-level situation representation

**Second-level Situations:** It combines two axes to represent a situation. In fact, combining axes generates richer situations (see Figure 32). The combination is produced by using basic primitives like, for example, Before (B) and Outside (O), combined to produce BO, which returns true if the user is before a given date/time & outside a given location. The combination produces also new primitives related to the combination of the combined axes.

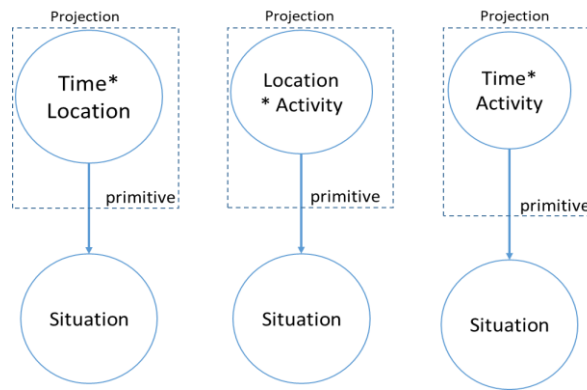

Figure 32 - Second-level situation representation

**Third-level Situations:** In this level, the richest situations are considered. A situation can be built as the combination of all the axes at once in order to position the situation in a precise contextual state. Figure 33 shows how a situation is built using the previously-stated primitives in all their possible combinations. As an example, we consider a user who has a meeting situation where he/she is in the meeting room AND it's between 8 am and 6 pm OR if the date of the monthly department meeting is due.

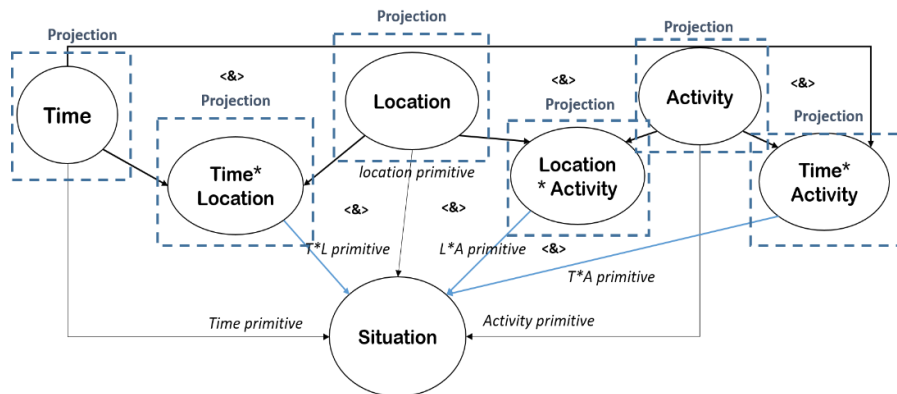

Figure 33 - Third-level situation representation

Furthermore, situations are represented using the presented concepts while respecting at the same time exceptions to those representations.

### 2.1.4. Representations

**Graphically:** Using operations and variables, a situation is represented through the defined concepts. The graphical representation is used to have a clearer understanding of the situations (see Figure 31, 32, and 33).

**Textually:** A situation S is presented textually in the following format, where P is a projection (the Tag will be discussed in Chapter 6):

*S : Tag ; Pn [ Axis(Primitive(values, tolerance)...); ...] [ ..] .. EXCEPT [Situation/Axis(..)]*

In the persistence layer (see Chapter 3), these textual representations are translated into XML and injected into the user’s application (Situation Repository) in order to define his/her situations.

For example, we present a 3rd level situation S1 (House Alarm Situation) that happens when the user is either outside his/her home with a 20 meters tolerance value (Projection1) or if the time is between 10 pm and 6 am with a 20 minutes tolerance (Projection2). The exception to this is being in only on Sundays. For our example, the graphical representation is shown in Figure 34. Textually it is presented like: *S1: Projection1[ Time( A(22,20) B(6,20) ); Location( I(Home,5) ) ] OR Projection2 [ Location( O(Home,20) ) ] EXCEPT [ ( Time(Sunday) ) ]*

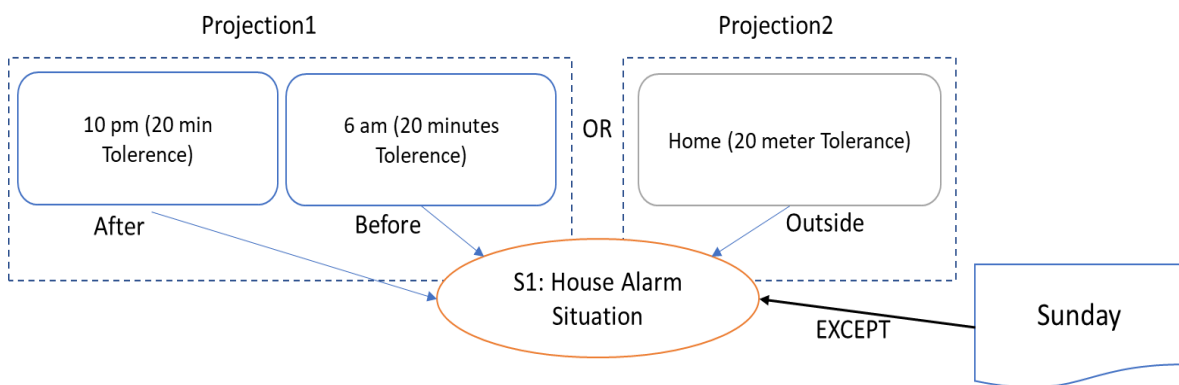

Figure 34 - House alarm situation representation

### 2.1.5. Complexity and data formats

Even though this representation is user-friendly regarding the way it is expressed, its management is complex. The complexity of detecting a specific situation can be estimated by considering the number of primitives involved in its computation by counting the number of projections and exceptions and multiplying the number of axes, primitives, and values involved  $(( \sum \forall p_i \# \text{primitives } p_j ) + \# \text{exceptions})$ . As different data get involved and the application grows, the situations can get detailed and complex. In Figure 35, we show how a situation can branch using all the concepts that we defined. It shows the richness and completeness of this modeling approach.

For the different axes, the data (values) are represented differently:

- Time-related values (*Date-Time, DTPrecision*): These values use the time *DD.MM.YYYY.hh.mm;ss*
- Location related values (*Location, LPrecision*): They are represented through geometrical geographical zones (GZ) delimited by points defined using GPS coordinates.
- Activity related values (Task, TaskList): An entity extracted from the user's calendars.
- Speed: This value is represented in the metric system (KmH).

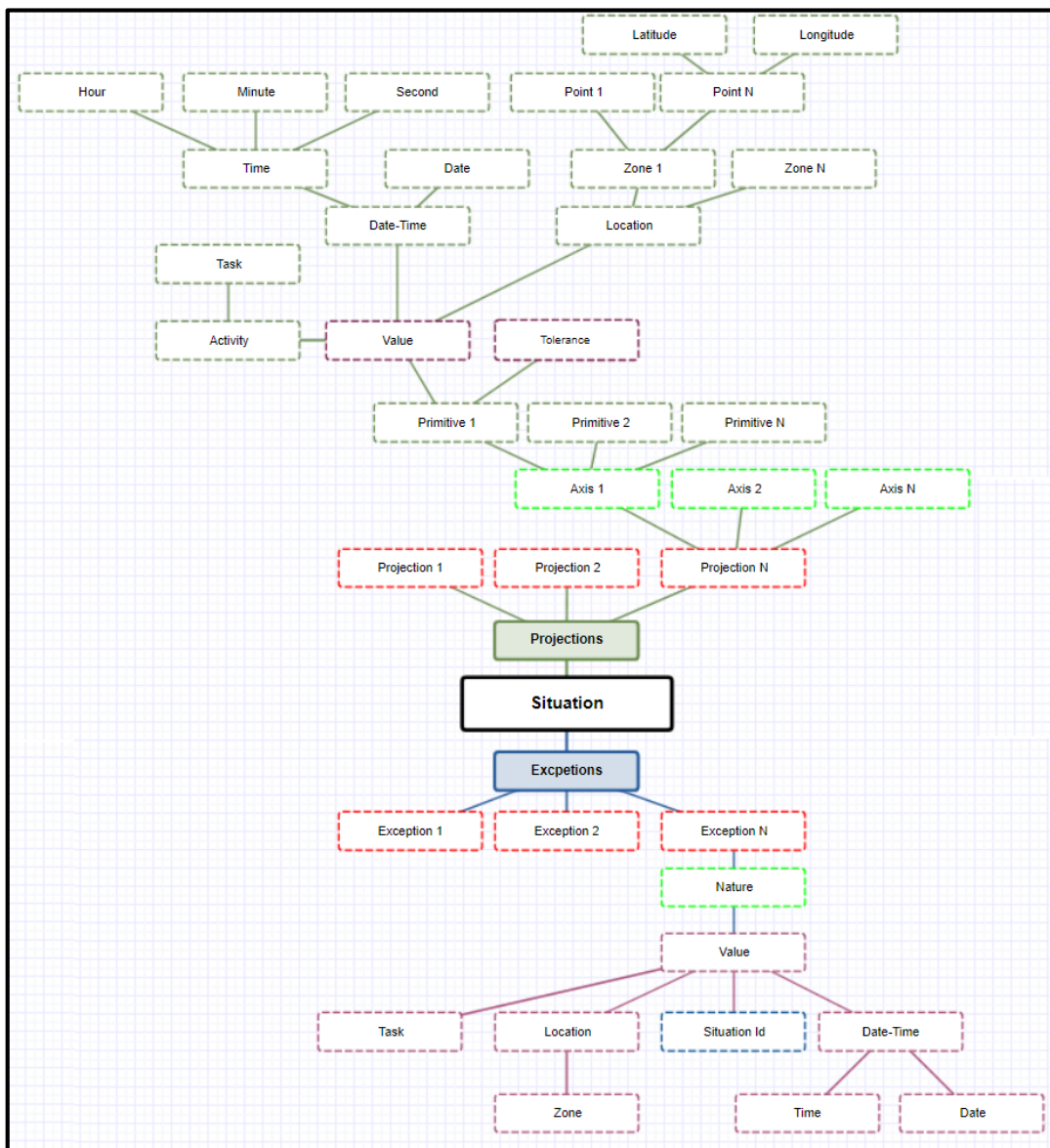

Figure 35 - Situation branching

## 2.2. Service level

On this level (see Chapter 6), our model allows describing the behavior expected when LLA detects situations. In order to react properly to these situations, the application needs to find the appropriate services.

**Service:** Services are the product of the application and its way to respond to contextual changes. They are the way the system responds when detecting that situation.

**Component:** The components are entities composing the service. The components can be divided into 3 categories: Input, Core, and Output (see Chapter 6). These components run simultaneously in a distributed environment composed of the users' devices. Each component serves a specific need and has hardware requirements (CPU load, RAM, camera, etc.) that need to be provided in order to run in an optimal way. Therefore, the representation on this level includes also the capabilities needed for components to run correctly.

**Mapping:** Mappings are associated with each situation. The mapping, (stored in the persistence layer) links the situations to the services. It describes the list of Kalimucho components needed to build the service.

## 3. Conclusions

A relevant aspect of the proposed application is the adequate detection of the context. For that purpose, the Long Life Application incorporates a rich situation model that considers any type of combination of three dimensions (Time, Location, and Activity) to represent different context situations where users can be involved, as well as exceptions for those situations.

For users, defining situations implies a simple understanding of the basic concepts. Therefore, using this model, they can easily define their basic situations and select/download the services adequate to those situations. For more experienced experts, the proposed model allows representing accurate specific situations related to their area of expertise using multiple projections, combined actions, specific tolerances, etc.

The next chapter is dedicated to present the second contribution of this work. It is focused on explaining in details the internal behavior of the cross-device context detection mechanism which is based on our situation-based contextual model.



---

---

*Chapter 5 - Cross-device situation detection*

---

## 1. Introduction

Context detection is the process of detecting changes in the context. In order to capture the context of the user, the application needs to collect the available information (such as time, location, and activity). This information needs to be extracted continuously, mostly by using the devices around the user.

In ubiquitous computing, context is often captured from one or more specialized sensor/device that could be physically close or attached to the user (phone, watch, tablet, etc.) or distributed around the user in his/her smart-environment.

LLA raises some challenges, due to its specific design requirements and the lack of an existing methodology and appropriate tools. The main important difficulties are related to the problem of context detection, software/hardware heterogeneity management, and the need to distribute the application around the available user's devices.

In this chapter, we present our proposal for a cross-device situation detection mechanism dedicated to the user's domain (see Chapter 3).

## 2. Cross-device situation detection mechanism

Context-awareness requires, by definition, a system able to detect the context and understand it. An important drawback of existing applications comes from identifying the user with one and only one device or from a pre-installed sensor network. Also, these applications limit their detection on the user's mobile phone. This issue motivated our work to be oriented to cross-device context detection dedicated to end-users and enabling the application to accurately follow and detect context changes.

In LLA, the context is represented by situations (see Chapter 4). Therefore, the proposed context detection mechanism considers the situation-based contextual model that we defined [78]. In order to detect situations (starting or ending), LLA starts by collecting contextual data input and then identifying situations.

From a technical and architectural point of view, the cross-device situation detection mechanism is composed of two main modules (see Figure 36).

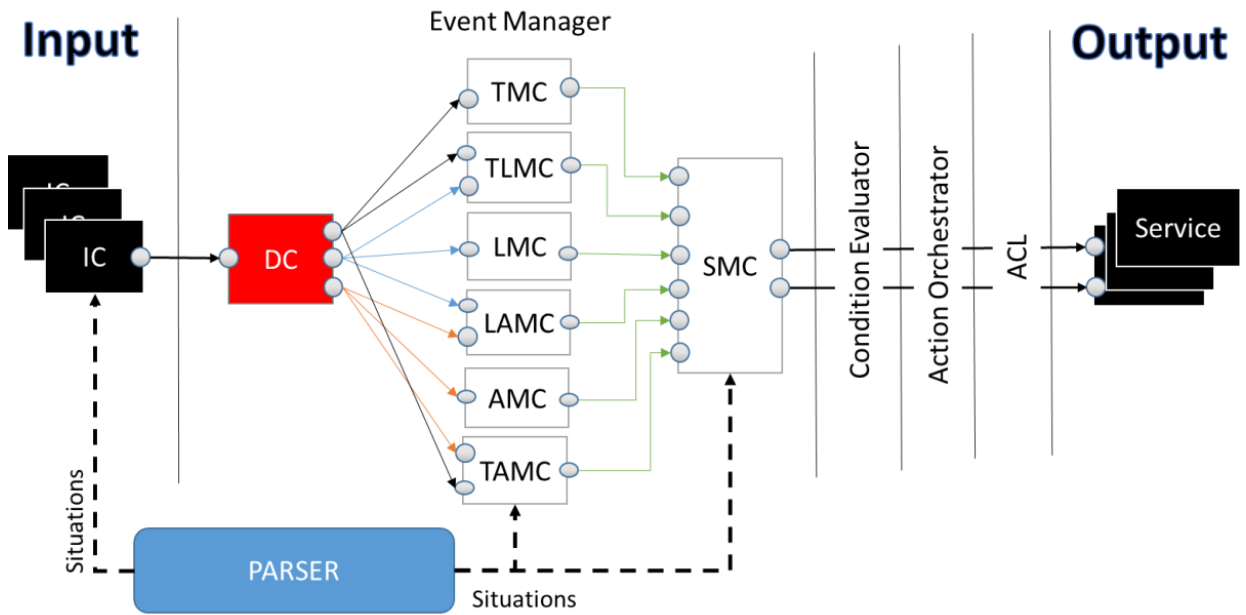

Figure 36 - Cross-device situation detection component architecture

The first module is the distributed Input module which is deployed on the user-domain (see Chapter 3). The second one is the Event Manager which evaluates the received data in order to identify possible situations that started and/or ended.

In Figure 36, the IC is the Input Component, the DC is the Dispatcher Component, the TLMC is the Time\*Location Manager Component, the LMC is the Location Manager Component, the LAMC is the Location\*Activity Manager Component, the AMC is the Activity Manager Component, the TAMC is the Time\*Activity Manager Component, and the SMC is the Situation Manager Component.

## 2.1. The Input Component (IC)

The first step in the process of detecting the context is to extract relevant data from the user's devices. In order to achieve this, LLA duplicates the IC on all the available and accessible devices of the user. The main objective of this component is to collect contextual information (current time, location, and activity) and send it to the Event Manager module.

This component is always running and waiting for contextual changes that can be interesting to trigger and send contextual data to the Event Manager (EM). The problem resides in the frequency at which this component should extract and deliver those data due to the hardware limitations of the device (e.g. battery). The simplest answer would be to perform it continuously

with a high frequency (e.g., every second), but this would require more processing power and drain the battery life faster.

Therefore, we propose a different mechanism, able to optimize its performance and not overload the EM. The modules that constitute the IC are shown in Figure 37.

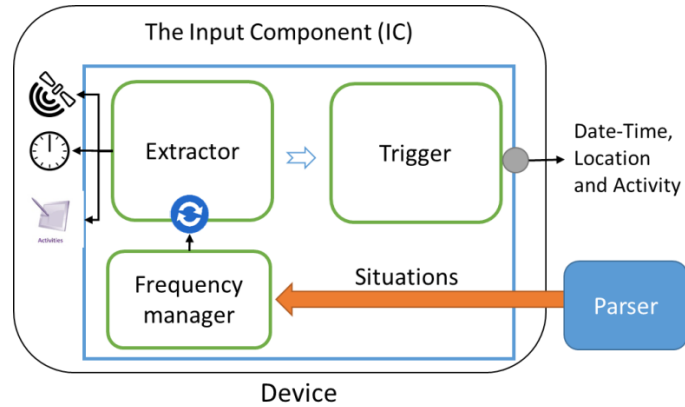

Figure 37 - The input component internal process

### 2.1.1. Frequency Manager (FM)

The IC orders the Extractor to extract data. Therefore, it takes into account the user's situation list. From this list, the FM calculates and optimizes the frequency at which the contextual data should be extracted from each device. In order to achieve this, granularities regarding the situation axes are taken into account by our proposal. Calculating these granularities, which affects the frequency, requires monitoring the situations for each axis separately. Any situation could have projections on each axis (time, place, activity) and must, therefore, trigger the extraction in time.

For the time axis, it is enough to awaken the process at certain well-chosen moments using *awake(S,D,Td)*:

- S = set of known situations for one day
- D = set of start and end dates for these situations
- Td = set of tolerances on these dates

We do not need a frequency because we know the dates. If D is ordered by growth dates and T is ordered in accordance with D, it is sufficient to wake up the process at each extraction time  $E_{Time} = \text{start date} - \text{the associated tolerance}$  and each  $E_{Time} = \text{end date} + \text{the associated tolerance}$ .

For the activity axis, the FM uses the same process used with the time axis,  $awake(S,A,C)$ :

- A = set of activities for these situations
- C = planned and non-planned tasks of the user

When considering planned tasks we need to define any frequency because we know their details (time, location). However, for non-planned tasks, there is no way to predict if the user is potentially interested in doing that task in a specific time/location frame.

For the location axis, we do not have a defined order since we do not know when the user will enter/leave these places (L). All we have are localizations (geographical areas with a tolerance).

- L = The set of places at the beginning and end of these situations
- Tl = set of tolerances on these places

A Geographical Zone (GZ = zone + a tolerance) is a greater geographical area, therefore, one reduces to geographical zones only (L and Tl are combined to form a single set L). These areas may overlap.

It is necessary to monitor the position of the user permanently to know when he/she is coming in / out of one or more of these zones. The extraction frequency, in this case, is complicated to define. Other works, consider a maximum extraction frequency and leave the GPS running all the time.

We propose to sample the accelerometer to detect the beginning of movements and launch the GPS using  $awake(L, Tl)$ . If two position measurements are taken separated by a known delay, it is possible to determine the position and the speed of movement of the user. As the current speed is known, it is possible to calculate the Minimal Time (MT) to reach/leave the geographical zone.

For each of the graphical zones (the shortest distance to get in/out of this zone), the minimal distance is calculated "on the fly" so the user cannot get in/out of that zone faster than the estimated minimum time. A new position and speed sampling will then be triggered within this period to see if this has occurred or not. The result will determine whether the situation begins or ends or a new delay to repeat the operation.

Each time the accelerometer gives a new value, the above process is repeated so that this delay is adjusted according to the new position/speed of the user. If the accelerometer does not

give anything, it means that the speed is constant and that the last calculation (MT) remains valid.

The last issue with this process is to determine the frequency at which the accelerometer is consulted. If it is awoken at a slow rate, we risk missing beginnings/end of movements and thus missing inputs/outputs of zones. Therefore, we decided to consider a high rate frequency because there is no way to predict that the user will move. This choice is justified by the comparison of power consumption of the accelerometer compared to that of the GPS, which proves that the accelerometer uses 7 times less the amount of energy used by a GPS [11].

### **2.1.2. Extractor**

The extractor receives notifications from the FM to retrieve the current time, location and activity on its device. The retrieved data could differ from one device to another. In a scenario where the user is traveling, some of his/her devices might be at home and therefore have a different time set on them.

This is interesting to ensure the continuity of the user situations even when he/she is in a different time zone. Locations are also different from one device to another, which is interesting but raises a problem of knowing where the user is physically located. For activities, the retrieved data will be the same between devices. Finally, the extractor transfers this data to the Trigger.

### **2.1.3. Trigger**

The trigger is the sub-module in charge of sending the data to the EM. Nevertheless, before sending that data, it verifies two important things.

First, it checks the real location of the user and the device with which the user is interacting (the one with which he interacts at that moment or he has lastly interacted with) by verifying if its screen is active or has been active lately.

The reason behind this is due to the fact that the IC is duplicated, and therefore it will be sending multiple times, locations and activities to the EM. This might cause the application to detect a situation without the user being really in that situation. This problem is related to the difficulty of creating a user experience that spans multiple devices [57].

For example, if the user is at work with his/her smartphone but he/she left his/her tablet at home, the context detected from the tablet is irrelevant to the user because of his/her current position. If the tablet detects a situation and reacts to it, the user will not be part of that situation.

The application should be able to understand that the user is actually at work and therefore detect only situations relevant to his/her true context.

In order to achieve this, the Trigger verifies first if the device where it is hosted has changed its position. If the device changed its position it means that it is moving with the user and therefore it is eligible to detect situations.

The second step is verifying whether the device being used by the user (active device). In case we have no position changes and no active devices, the application considers data only from the last used device or the devices in proximity of that device in order to have a relevant context.

Finally, the IC sends the collected relevant data to the EM in order to start the process of identifying the situations that are possibly beginning or ending.

## 2.2. The Event Manager (EM)

The EM is the entry point to our application's core and represents the E in our ECA approach. Overall, this module is dedicated to detecting context changes. For that purpose, it first receives the input coming from the IC and then runs a discovery process on the potential situations. As output, it delivers lists of situations that are about to start and those about to finish.

The Event Manager module (see Figure 36) is in charge of detecting contextual information from around the user (from his/her devices), analyzing these data, and defining a context respecting the situation model.

The situation identification process (see Figure 38), integrated into the Event Manager, is the mechanism that monitors the different axes and creates the appropriate situations by using collected data from around the user and combining them with primitives.

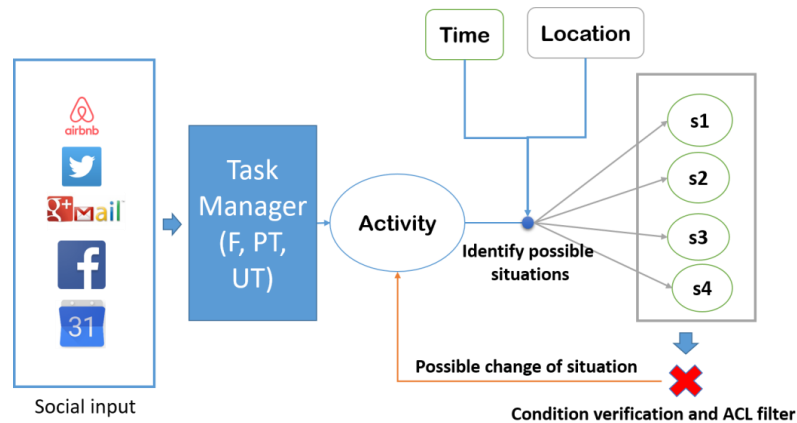

Figure 38 - Situation identification process

The task manager extracts data from social media and rich sources of information available. After organizing the tasks (task list) and finding the users' free time, it feeds the activity axis. Simultaneously, it identifies the possible situations by monitoring the time and locations of the user.

EM is composed of components (see Figure 36) that interact together to achieve the situation detection. These components each have their inputs and outputs.

### 2.2.1. Dispatcher Component (DC)

This component (see Figure 39) considers the importance of the main starting point of distributed architectures. In these architectures, it is necessary to have a component capable of managing the rest of components and communicating with them in order to know their status and workflow.

As its name suggests, this component dispatches the received data to the appropriate components. It represents the entry point to the workflow and the main component of the EM. Besides, it monitors the other components of the EM.



Figure 39 - The dispatcher component

### 2.2.2. Axes Management Components

Time, Location, Activity, Time \* Location, Time \* Activity, and Location \* Activity Manager Components are respectively TMC, LMC, AMC, TLMC, TAMC, and LAMC.

When the ECA core starts, the parser goes through the situations in the persistence layer in order to send to each component the situations related to their specific axis. They apply the primitives related to their specific axis. They start by receiving the current time/location/activity from the DC and then begin to analyze the situations. After identifying the valid situations (situations that verify their primitives on the respective axes), these components send them to the SMC (see Figure 40).



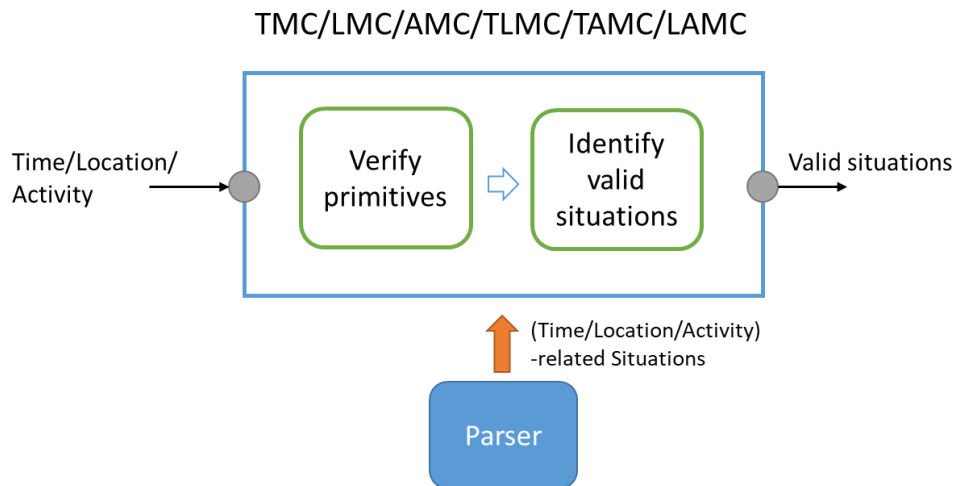

Figure 40 - Time Manager Component

### 2.2.3. Situation Manager Component (SMC)

While receiving a list of valid situations from the other components TMC, LMC, AMC, etc.), the SMC (see Figure 41) constructs one final list containing the situations (received from the other components) according to their occurrences and their projections. In this way, this component delivers two final lists of situations as a final output of the EM. These situations could be either situations that will be starting or situations that are no longer valid and need to end.

In order to identify the starting situations, the SMC calculates for each received situation the number of projections and axes represented in that projection and compares them with the input of the other components (TMC, TLC, etc.). If the number of incoming instances of a situation (verified by the primitives) matches one of the projections, it is considered as a possible situation to start (to start a situation, it should verify at least all the primitives of one projection). For example, if a situation  $S_0$  happens when the first projection is verified (user is home at 5 pm), the SMC should receive 2 instances of  $S_0$  coming from TMC and LMC.

For ending situations, the SMC uses the opposite mechanism: if at least, one occurrence is not sent to the SMC, it considers that situation as a stopping situation (to break the situation, it is enough that one primitive verification fails). Using the same example of  $S_0$ , if the user leaves the house and the SMC receives only one instance (coming from TMC), it means that the projection of  $S_0$  is no longer verified then it should be stopped.

Then, the SMC verifies the exceptions related to situations about to start. If they violate any of the exceptions they are retracted from the starting list. For ending situations, the exceptions can expand the lifespan of a situation as long as that exception is valid.

This component has also a list of Active Situations, which represents situations that are already running (still verify the primitives of their projections). A possible starting situation will not necessarily be an active one, as it might be filtered later by one of the next modules (CE, AO, or ACL). For ending situations, however, they must be already active in order to be stopped.

Finally, the final lists of situations are transferred to the Condition Evaluation (CE) module.

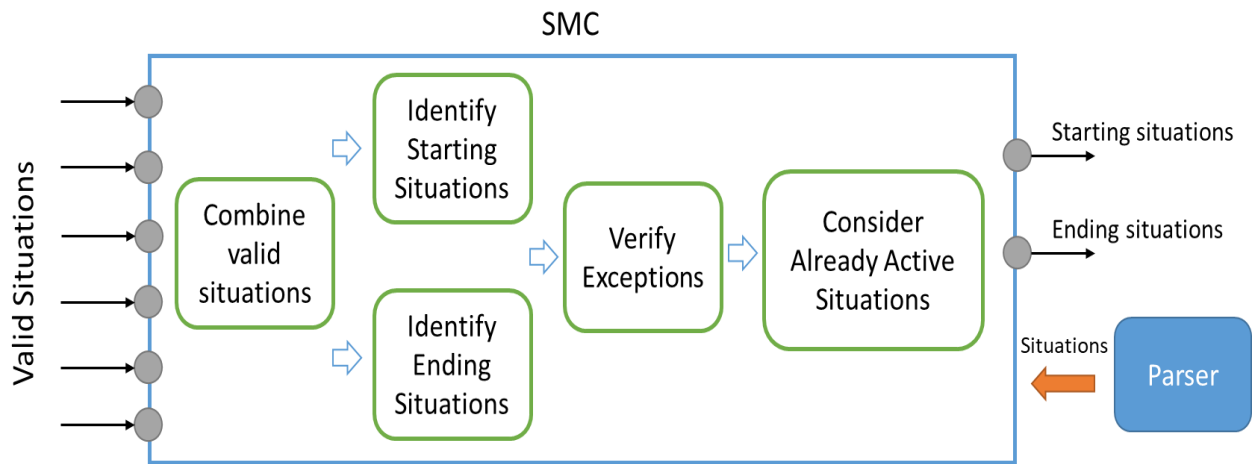

Figure 41 - The Situation Manager Component

In this example, we consider the previously described House Alarm Situation (see Figure 34). We describe below a number of various situations that could happen to the user daily.

```

** House Alarm Situation(S0): P1[ Time( After(22,20) Before(6,20) ); Location( Inside(Home,5) )
] OR P2 [ Location( Outside(Home,20) ) ] EXCEPT [ ( Time(While(Sunday,0)) ) ]
**Sleep/Wakeup situation(S1): P1[ Time(While(7,10)); Location(Inside(Home,50))] EXCEPT [ (
Time(While(Sunday,0)) ; Location(Outside(Home,10))]
**Breakfast situation (S2): P1[ Time(After(7,10)Before(7:30,10)); Location(Inside(Home,50))]
**Way to work situation (S3): P1[ Time(Before(9,30));
Time*Location(Closer(Office,9,10,100,25))] Time(While(Sunday,0))
**First Work shift Situation (S4):P1[ Time(After(9,10)Before(12,10));
Location(Inside(Office,50))]
**Lunch Situation (S5): P1 [Time (While (12, 30))]
**Second Work shift Situation (S6): P1[ Time(After(14,10)Before(17,10));
Location(Inside(Office,50))]
**Massage session situation (S7): P1[ Time(While(Monday/18,10));
Location(Inside(MCenter,20))]
**Shopping situation (S8): P1[ Time(After(19,30)); Location*Activity
(Opportunity(Carrefour,100, "Shopping")); Activity(Free(TL,PA))]
**TV night situation (S9): P1[ Time(After(20,20)); Location(Inside(Home,50));
Activity(UnplannedTask("FavoriteShow",PA))]

```

In Table 11, we present an example of a user having the situations described above. In this example, the user has three devices where LLA is installed. We follow him/her on three steps where the user changes time, location and activity over the day. We consider that the IC only extracts data those three times. Initially, we propose that S0 (House Alarm Situation in Figure 34) is an active situation, the time is 6 am; the day is Monday and he/she is at home.

In table 11:

- T: Time;
- L: Location;
- A: Activity;
- Sits: Situations;

Table 11: Situation analysis by the Event Manager's components

		Device 1 (Smart-Watch)			Device 2 (Tablet)			Device 3 (Smart-Phone)											
		Input			Input			Input			Event Manager								
		T	L	A	T	L	A	T	L	A	DC	TMC	LMC	AMC	TLMC	TAMC	LAMC	SMC	
t e p 1	Data	07:00	home	free	08:00	home	free	07:00	home	free	→	07:00	home	free	07:00, home	07:00, free	home, free		
	Valid. Sits											S1, S2	S0, S1, S2, S9	S8	--	--	--	→	
	Activ. Sits																		S0
	Start. Sits																		S1, S2
	End. Sits																		S0
t e p 2	Data	10:00	Office	work	10:00	home	work	10:00	Office	work	→	10:00	Office	work	10:00, Office	10:00, work	Office, work		
	Valid. Sits											S4	S4, S6	--	S3	--	--	→	
	Activ. Sits																		S1, S2
	Start. Sits																		S4
	End. Sits																		S1, S2
t e p 3	Data	18:00	MCenter	free	18:00	home	free	18:00	Mcent	free	→	18:00	MCent	free	18:00, MCent	18:00, free	MCent, free		
	Valid. Sits											S7	S7	S8	--	--	--	→	
	Activ.Sit																		S4
	Start.Sit																		S7
	End. Sits																		S4

In Step 1, the data extracted from all the devices is the same (07:00, Home, Free). The DC distributes the data to the rest of components (running on the Smart-Phone). We considered that S0 (House Alarm Situation) was already active. After all, components send the valid situations to the SMC, it calculates the starting and ending situations. It decides to stop S0, because one of its primitives (*Before(6,20)*) is no longer verified, and to start S1 (Sleep/Wakeup) and S2 (Breakfast Situation) because all the primitives in their respective projection are verified.

In Step 2, the user left home but left his/her tablet there. Therefore, the data extracted from that tablet will not be sent to the EM. The data considered comes from the Smart-Phone and Smart-Watch (10:00, Office, Work). The DC distributes the data to the rest of components. After all, components send the valid situations to the SMC, it calculates the starting and ending situations. It decides to stop S1 and S2 (already active), because their primitives are no longer verified, and to start S4 (First work shift situation) because all the primitives in its projection P1 are verified.

In Step 2, the data considered still comes from the Smart-Phone and Smart-Watch (18:00, MCenter, Free). The DC distributes the data to the rest of components. After all, components send the valid situations to the SMC, it calculates the starting and ending situations. It decides to stop S4 (already active) and to start S7 (Massage session situation).

This example presents the workflow of the cross-device detection mechanism. The output (Starting situations, Ending situations) of this mechanism is sent to the rest of the architecture (CE, AO, ACL) in order to finish the rest of the process.

### 3. Conclusions

To summarize, our proposal provides a mechanism able to detect, formalize and understand the user context. The EM provides a set of components working simultaneously and independently in order to detect events and understand situations regardless of the source. However, detecting situations is not our main goal. In related works, most application use rule-based languages to detect events and to understand the context, others use information collected from sensors in order to formalize a context from that raw data.

Our approach differs in the way we address context detection as we aim our model to be centered on the user daily needs in a connected environment. This means that our mechanism can handle both basic and complex representations of everyday situations. It considers high-

level context understandable by the user and that does not need necessarily the presence of, a sensor network or a huge set of complex rules.

Our approach provides a light, dynamic and open to growth contextual model. The second phase of responding to the contextual change is handling this change on the service layer of the application. Therefore, the next chapter presents the situation control and handling strategy which is integrated into LLA and dedicated to offering an improved user experience.

---

---

*Chapter 6 – Situation Control and Reaction strategy*

---

## 1. Introduction

After defining the modules specialized in modeling, understanding, and detecting context, we present in this chapter the way that LLA handles the contextual changes.

In context-aware applications, handling contextual changes comes in various and different ways and forms (see Table 4). The common aspect between these applications is that they offer services in response to contextual changes. Using the same logic, LLA translates situations to use cases that are submitted to conditions and that could trigger a change in the service layer if needed.

Nonetheless, when it comes to reacting to context, applications struggle to provide the adequate services that users expect because they limit their architectures to pre-packaged features that are already coded inside the applications. This limitation bounds their application and narrows the range of use cases that could be handled.

Moreover, they do not usually consider the user's preferences, constraints, and priorities when it comes to overlapping situations and handling priorities. Works like [31] use preset goal hierarchies that they deem relevant and interesting to their users.

In this chapter, we present the rest of the architecture (see Figure 23), discussed in chapter 3, by showing the interactions between the modules dedicated to offering a response when the context of the user changes.

## 2. Situation control and reaction strategy

This part represents the reactive aspect of our proposal. It is the combination of different mechanisms and modules that work simultaneously inside the main application. The main goal of these modules is to respond to the detected situation in the best way possible for the user.

The process of reacting to these situations starts by evaluating them. The Condition Evaluator (CE) acts as an organizer and a filter for new situations. It considers the user's constraints and restrictions (e.g. the user does not want to be bothered between 5 and 10 pm) and manages the concurrency of situations by following a defined priority model.

The second level is the Action Orchestrator (AO) module. It takes as input both starting and ending situations and launches/stops the appropriate services for that specific situation by using the Kalimucho platform commands (see Appendix 1). Nonetheless, before launching/stopping the services on the user domain, the AO needs to be aware of the available and accessible devices in the user-domain.



Therefore, the last module is a domain management filter based on ACL [89] which scans the environment continuously for new connected devices, secures the data transfer, and keeps monitoring the user-domain.

### **3. Condition Evaluation (CE)**

Condition evaluation is the second constituent of the ECA core. This module is required to consider the user as the main interest of his/her application by giving him/her the upper hand (control) and making him/her define the constraints that bind LLA.

As he/she is constantly moving and evolving in his/her surroundings (Time, Location and Activity), multiple situations could be detected simultaneously which will trigger the application to react automatically in order to respond to those situations.

Thus, the user could be overwhelmed with situations and deployed services. In order to remedy this problem, the Condition Evaluator module respects a priority model that calculates the situations' priorities in order to filter the least important ones or put the other ones on hold until LLA detects a change in context.

Moreover, it considers constraints described by the user in order to stop, filter, hold situations if the user does not want to be disturbed. In our vision of LLA, it is necessary to consider the status of the user. The status represents if the user is free, busy or wants to not be disturbed at all. Most users have different schedules through the day. For example, a person with a daily job in an office is usually busy working from 9 am to 5 pm and does not want to be disturbed at night. This motivated us to implement the CE module that takes into account all these parameters. This module complements the contextual awareness of our proposal.

#### **3.1. The situation priority model and constraints**

Context-aware applications are, most of the time, dynamic and autonomous. LLA is centered on the user and dedicated to his/her needs and constraints. Therefore, our proposal implements the CE module in order to consider the user's constraints and give him/her the ability to fully control what happens.

In order to achieve this, the CE follows the constraints and priority model expressed by the user. Expressing this information is done following three steps:

- Tagging the situation with an importance level. This tag is defined when injecting the situation for the first time. The Tag is described textually in this format: *[priority=P(x); source="Source"]*. It serves as the default priority value of a situation. This value could be altered for specific conditions (see Figure 42). LLA considers three different importance levels:
  - *Casual situations*: Situations with the least priority (1) representing the user's everyday situations.
  - *Important situations*: Situations with medium priority (2) representing use cases related to work, travel, etc.
  - *Urgent situations*: Highest priority situations (3) representing urgent use case that need to be handled immediately.
- Creating and activating “lock zones” (see Figure 43) that allow filtering situations considering their level of priority. These zones can be described only on Time and Location axes because they define the status of the user (free, busy, to not be disturbed) and this status cannot be linked to the human activity of the user. This means that a zone can be timely or geographically defined. We defined three levels of zones:
  - *Free zone*: This zone is the default level where any situation is equal and able to be handled. If no other zone is defined, this zone will be considered as the default state if no other zone is active.
  - *Busy zone*: This level allows only important and urgent situations to be handled.
  - *Dead zone*: This is the highest level zone where only urgent situations are allowed. It represents the zone where the user does not want to be bothered with anything unless it is urgent.

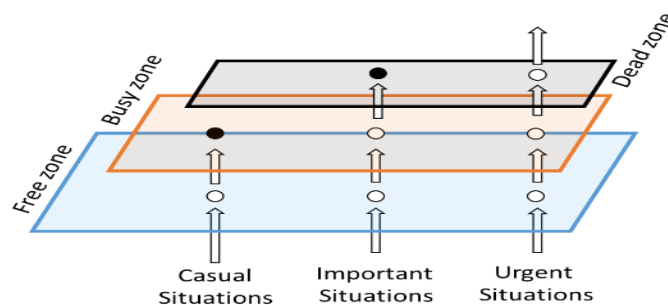

Figure 42 - Filtering layers of situations

- Defining the priority level for the different sources (see Chapter 7) of situations. These values are needed to calculate the relative importance of any given situation to the user of the application. As every user is different, these values will reflect how he/she presents his/her understanding of the importance of his/her situations. In Chapter 7, we introduce the concept of situation sources (User, Social, and External). The Situation Source Priorities shown in Figure 43 are the default values used if the user does not specify any different values. The calculated priorities help the CE to manage situation concurrency when and if it happens. In figure 43, we show the relation between priorities, dynamicity, and privacy. When going from the free to the dead zone we gain in privacy. In the other way, the user gains in dynamicity and reactivity. By implementing this concept we allow the user to choose the way he/she wished his/her application reacts.

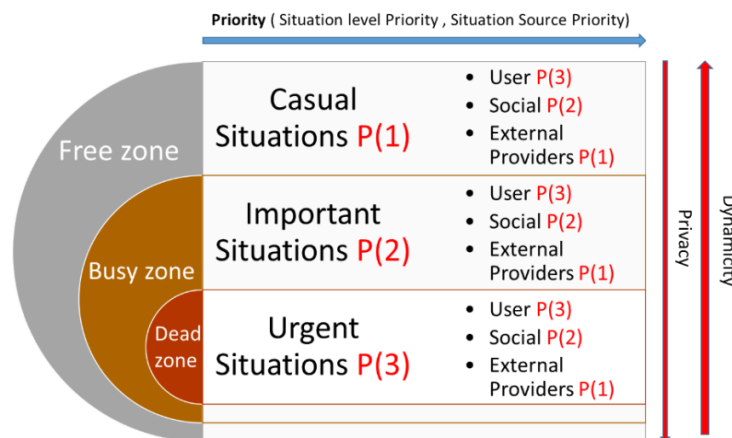

Figure 43 - Lock zones and priorities

Inside the conditions repository of LLA, all information related to zones and priorities are stored into a *Conditions* file that is synchronized with his/her cloud storage. Using the LLA management UI, the user can, at any time, modify/delete/add/activate/de-activate lock zones. He/she also can redefine any priority for any specific situation or injection source inside a defined zone. These zones and priorities (conditions) are described using the same rules, primitives, and operations as the contextual model (see Chapter 4) in order to keep the coherency of the approach. Therefore, conditions can be described both graphically and textually, except for the free zone because it represents the default state where no description is needed and LLA is freely running.

- Graphically:** This representation (see Figure 44) shows that for each zone, except the free zone, the user could redefine the priorities regarding his/her sources and situations.

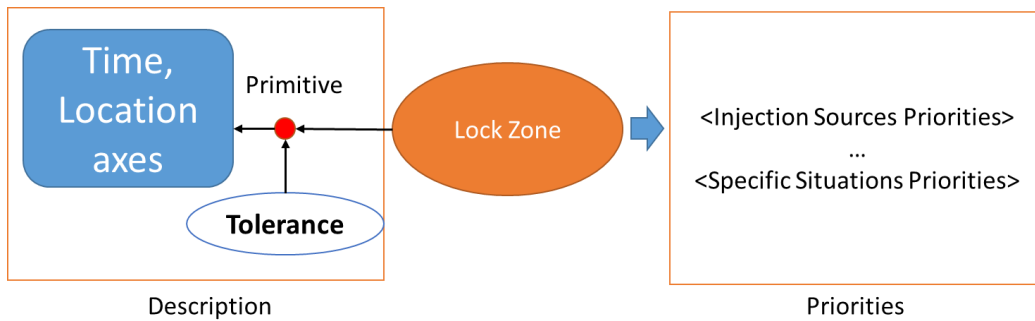

Figure 44 - Graphical representation of lock zones

- Textually:** The lock zone could be also defined textually using the following representation where Z is a zone, D is a description, ISP is Injection Sources Priorities, SSP is Specific Situations Priorities, and P is a priority:

**Z: [Time/Location (Primitive (values, tolerance)...)]; [ISP [(Source, P)...]; SSP [(situation, P)...]]**

The constraints and situation model helps LLA fully understand the user’s preferences and filter situations in order to only consider pertinent ones.

An example for this could be shown by a user who represents his/her constraints in order to reflect his/her habits. Let’s consider that this user splits his/her day into four zones. In the following paragraph, we describe these zones graphically and textually.

- The first zone (see Figure 45) is a busy zone defined on the time axis starting from 6 am to 8 am with 10 minutes tolerance. In this zone, the user wants to prioritize situation injected by himself/herself and his/her social environment and related to his morning habits.

*Morning Busy Zone: [Time (After (6am, 10m); Before (8am, 10m))]; [ISP [(User, 3); (Facebook, 3); (Google, 2)]; SSP [(Coffee Situation, 3); (Weather Situation, 3); (Email Situation, 2)]]*

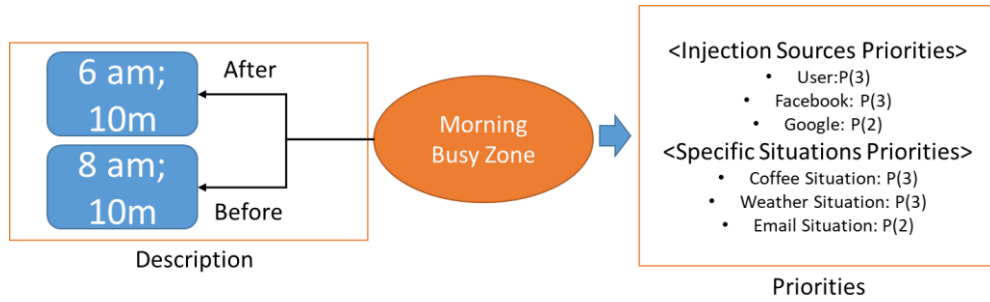

**Figure 45 - Morning Busy Zone representation**

- The second zone (see Figure 46) represents his work environment. It is represented using the location axis (workplace) with 50 meters tolerance. In this zone, he/she prioritizes work-related situations injected from his/her employer.

*Work Busy Zone: [Location (Inside (Workplace, 50m))]; [ISP [(User, 1); (Boss, 3); (Google, 1)]; SSP [(Work Situation, 3); (Meeting Situation, 3); (Email Situation, 2)]]*

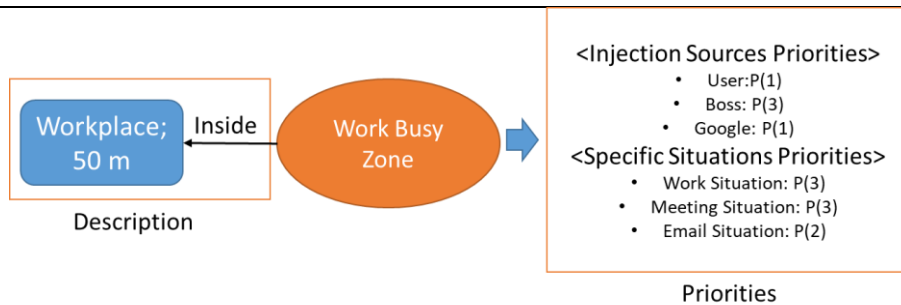

**Figure 46 - Work Busy Zone representation**

- The third zone is a dead zone (see Figure 47) that highly limits and filters situations in order to not disturb the user unless something urgent happens (Government). This zone is defined from 10 pm until 6 am at the user’s house.

*Sleeping Dead Zone: [Time (After (10pm, 10m); Before (6am, 10m)); Location (Inside (Home, 50m))]; [ISP [(User, 1); (Government, 3); (Security Company, 3)]; SSP [(Alarm Situation, 3); (Wakeup Situation, 3); (Email Situation, 1)]]*

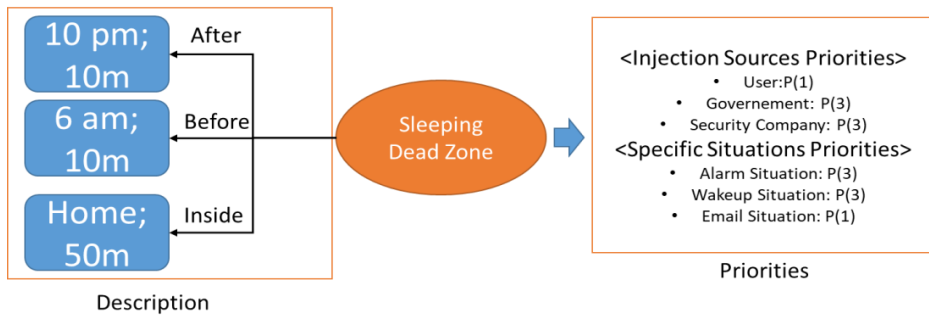

Figure 47 - Sleeping Dead Zone representation

- The fourth zone represents the rest of the day. It is, by default, a free zone. According to what the user has defined, in a free zone, situations coming from social and external sources are prioritized.

### 3.2. Condition Evaluator module’s components

This CE, presented in Figure 48, is composed of three kalimucho components running simultaneously in order to provide the wanted result.

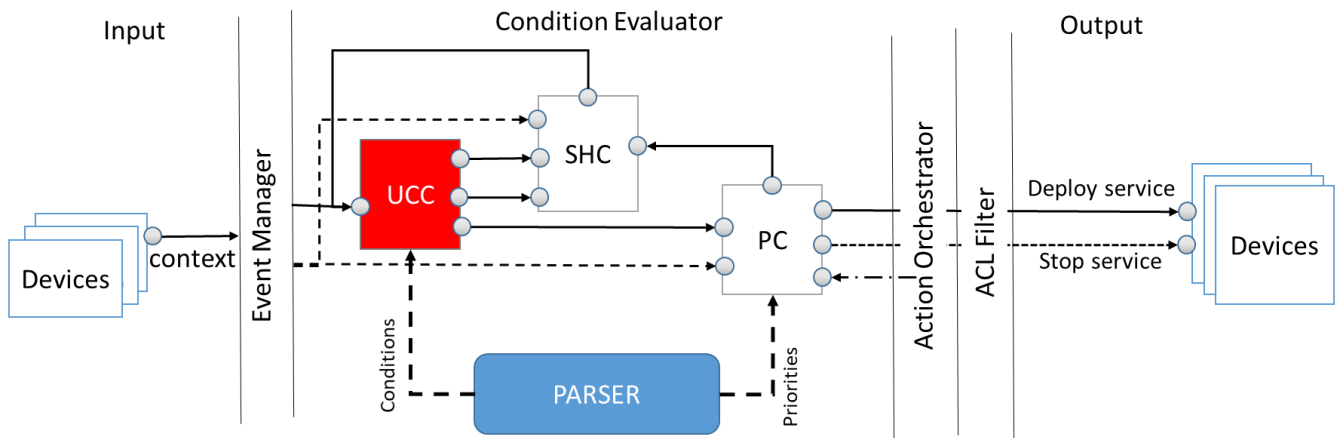

Figure 48 - Condition Evaluator's internal architecture

The process of evaluating conditions starts by the User Constraints Component (UCC) which monitors if the detected situations (from the Event Manager) violate the user’s constraints then transfers them either to the Situation Holder Component (SHC) or the Priority Component (PC).

If the situation has the needed priority and does not violate the user’s constraints, it is transmitted to the Action Orchestrator in order to deploy the appropriate services. This module

follows the condition repository where the application stores the user’s constraints and priority model.

### 3.2.1. The User Constraints Component (UCC)

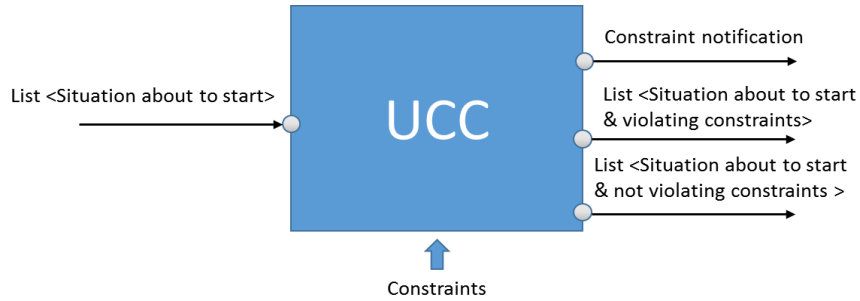

Figure 49 - User Constraints Component

The UCC (see Figure 49) has one input which consists of a list of situations that are detected and that are about to start (coming from the Event Manager). This component verifies that these situations do not violate the user’s zones (see Figure 42). It ensures that only situations that are eligible to start are transferred to the PC. The ones violating these zones are sent to another component that keeps them on hold (see SHC). This component also notifies the SHC when there is a change in the current lock zone (e.g. from Free to Busy) so the SHC can re-send the held situations to be re-evaluated by this component.

### 3.2.2. The Situation Holder Component (SHC)

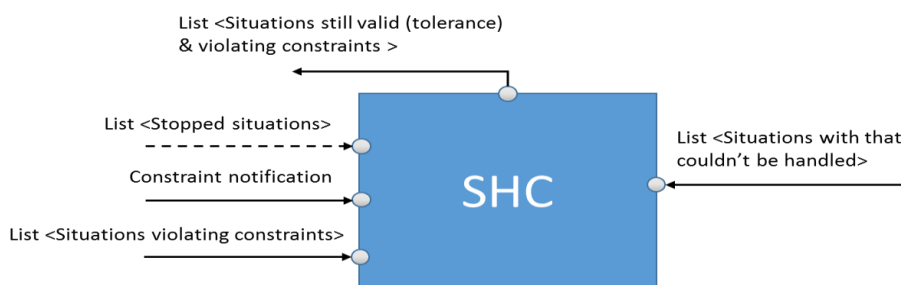

Figure 50 - Situation Holder Component

This component (see Figure 50) acts as a holder for two types of situations: Situations violating constraints; Situations that are valid but could not be handled due to the lack of a required resource (camera, micro etc.). This component is a thread continuously verifying if the held situations are still valid, which means that those situations didn’t overflow their respective projections.

If it receives a constraint notification from the UCC, it sends back all the held situations to the UCC in order to re-verify if they do not violate the constraints. If it receives a list (or single) of situations to stop it removes them from the list of situations held.

### 3.2.3. The Priority Component (PC)

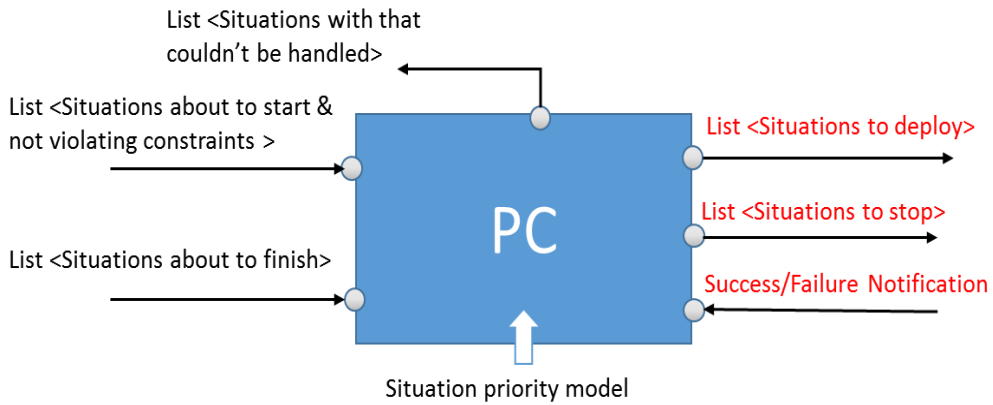

Figure 51 - Priority Component

This component (see Figure 51) is in charge of managing priority aspects for the user’s situations. Using the defined priority model, this component calculates, according to the urgency level of that situation and its source, the level of priority it has. It receives 2 types of situations: Situations about to finish, which it will transfer to the next module without any changes; Situations about to start (from SHC and UCC) for which it calculates the priority levels. When multiple situations (starting and stopping) are detected and sent to this component at the same time, it sorts them according to their priority and then transfers them to the AO. In order to have a better chance of deploying the needed services, this component prioritizes stopping already running situations if they have higher priority than the situations that are about to be handled. When a situation is successfully handled it sends back a Success Notification to tell the PC to send the next situation. If it fails it sends a failure notification so that situation is transferred back to the UCC.

### 3.2.4. Example

In order to illustrate how the Condition Evaluator works, we study the example described in Figures 52. The user is in a busy zone before 6 pm, on a free zone from 6 pm to 10 pm, and on a dead zone after 10 pm. An interesting use case is presented in this scenario. When sleeping, unexpectedly, a terrorist attack happened in Paris. To check that people are safe, the police



urgently notify anybody near the attack location to change their direction, Facebook also sends their safety verification service to check if people around the attack area are safe. At the same time, the app detects that there is an important situation to John, injected by his boss, but cannot handle the situation because the situation is not urgent.

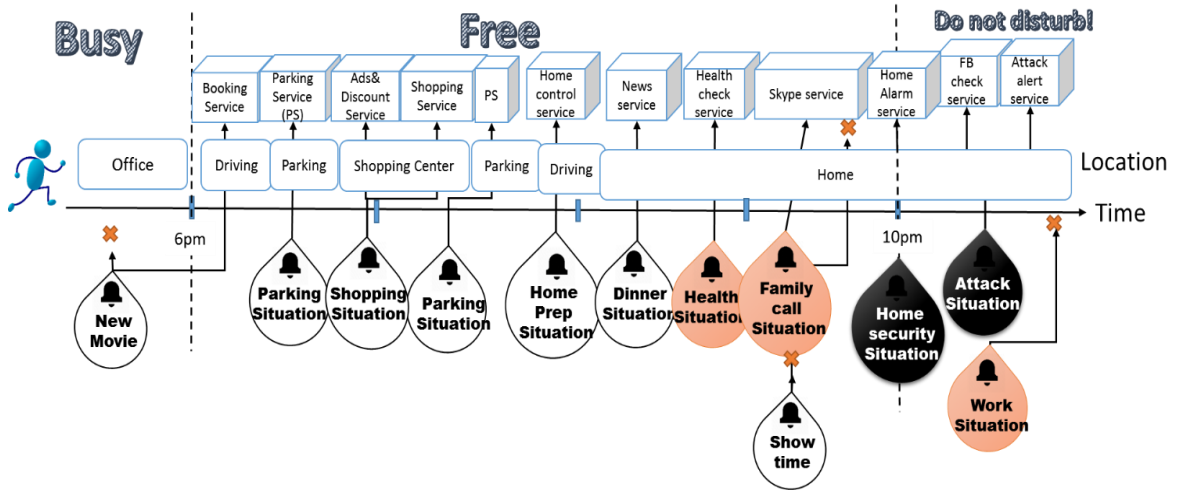

Figure 52 - Example scenario representation

For the purpose of focusing on condition evaluation, in the textual description below, we only show the default tag of priorities and sources (see Chapter 6) of situations (no textual contextual representation).

- \*\* *New Movie (S0): [priority=P(1); source=External/cinema]*
- \*\* *Parking situation (S1): [priority=P(1); source=External/Carrefour]*
- \*\* *Shopping situation (S2): [priority=P(1); source=User]*
- \*\* *Home preparation situation (S3): [priority=P(1); source=User]*
- \*\* *Dinner situation: S4: [priority=P(1); source=User]*
- \*\* *Health situation (S5): [priority=P(2); source=External/Doctor]*
- \*\* *Family call situation (S6): [priority=P(2); source=User]*
- \*\* *Showtime (S7): [priority=P(1); source=External/Netflix]*
- \*\* *Home security situation (S8): [priority=P(3); source=External/SecurityCompany]*
- \*\* *Attack Alert situation (S9): [priority=P(3); source=Social/Facebook]*
- \*\* *Work situation (S10): [priority=P(2); source=External/Boss]*

Table 12 presents the evolution of the user’s situation and priorities relative to his/her current lock zones. It shows the inputs and outputs of the CE components.

Table 12: Situation filtering by the Condition Evaluator’s components

			Busy zone	Free zone				Dead zone		
			--6pm	6pm-7pm	7pm- 8pm	8pm-9pm	9pm-10pm	10pm--		
UCC	Inputs	Starting situations	S0	S1, S2	S1, S3	S4, S5	S6,S7		88   S9, S10	
	Outputs	Constraint notification	--	Free	--	--	--	Dead zone		
		Starting Situations violating constraints	S0	--	--	--	--	--	S10	
		Starting Situations not violating constraints	--	S1,S2	S1, S3	S4, S5	S6, S7		S8   S9	
SHC	inputs	Stopping situations	--	--	S0, S1 (first)	S1, S3	S4, S5		S6, S7	
		Starting Situations violating constraints	S0	--	--	--	--	--	S10	
		Constraint notification	--	Free	--	--	--	Dead zone		
		Situations that cannot be handled	--	--	--	--	-	S7	--	
	outputs	Situations still valid	--	S0	--	--	-	S7	--	
PC	inputs	Starting Situations not violating constraints	--	S0,S1,S2	S1, S3	S4, S5	S6, S7		S8, S9	
		Finishing situations	--	--	S0, S1 (first)	S1, S3	S4, S5		S6, S7	
		Success notification	--	S0,S1,S2 success	S1, S3 success	S4, S5 Success	S6 success S7 failure		S8, S9 success	

	<b>outputs</b>	<b>Situations that cannot be handled</b>	--	--	--	--	- -	S7	--
		<b>Situations to deploy</b>	--	S0 then S1 then S0	S1 then S3	S4 then S5	S6 then S7		S8, S9
		<b>Situations to stop</b>	--	--	S0, S1 (first)	S1, S3	S4, S5		S6, S7
<b>AO</b>			--	S0, S1, S2	S1, S3	S4, S5	S6, S7		S8, S9

The most interesting output of this module comes from the PC, which decides the order of the situations eligible to be handled and those that will be stopped. This output is linked to the action module of the ECA core.

#### 4. Action orchestrator (AO) and Access Control List (ACL) device filter

After detecting the user’s context and considering his/her constraints and conditions, the process of LLA comes to the final step. This step is focused on the devices instead of the user in order to illustrate our fourth and final contribution of this work (see Chapter 3).

In this part, we present two mechanisms that work simultaneously to exploit the user-domain (see Figure 26). These modules allow LLA to react to the detected situations in the way that the user expects.

LLA handles the received situations (to start or to stop) by deploying or removing services on/from the devices in a user-centered yet distributed way. This approach guarantees the continuity, sustainability, and scalability of the services integrated into LLA by being able to move their components freely between devices at run-time. In order to apply this approach, LLA needs to implement the concepts of the service level of the situations (see Chapter 4).

Thus comes the need to categorize and specify the capabilities of the devices that will host the services of the user. This also helps LLA in the matching process which links situations to services expected by the user. Moreover, we need a modular service composition allowing the needed dynamicity for LLA and providing a clear definition of the requirements and goals of the components. Finally, we present the components composing the AO and ACL filter by defining their inputs/outputs and workflow.

### 4.1. Device capabilities

The distributed nature of LLA imposes that we consider a great number of devices simultaneously. These devices are usually different in terms of hardware and capabilities. This factor is very important for LLA because it affects directly where and how services run inside the user-domain.

Therefore, for each device, LLA should have a clear full description of its capabilities and accessibility (see Chapter 3). To do so, every device on the domain must provide to the rest of the devices its description (capabilities and accessibility). This information is stored into the “DeviceCapabilities” file when LLA is first installed. This file contains three categories of information.

- *Dynamic capabilities*: These capabilities represent the hardware specifications that have different states (Status). For example, the Battery level is a changing value that could be interesting to be monitored on the run in order to sustain LLA and have no interruptions. This is represented by the “Status” column.
- *Static capabilities*: These capabilities represent hardware specifications that cannot evolve (Model, Power, Unit, Returned data type). A camera with 12MG, for example, will always retain that feature all the time.
- *Concurrency capabilities*: The concurrency (Availability) represents the availability of the resources that cannot support multiple usages or be shared between different services. The Microphone, for example, is a resource that requires being used only by one process (component) at a time.

This information is presented in a structured way that helps the AO to know the full status of the device and decide if it is eligible to deploy the component.

Capability	Model	Power	Unit	Returned data type	Status	Availability
------------	-------	-------	------	--------------------	--------	--------------

As an example, we consider a Samsung Gear S3 [45] (smart-watch) that has LLA installed and running. Table 13 represents its capabilities at a random time when the user is making a phone call using it.

Table 13: Samsung Gear S3 capabilities

Capability	Model	Power	Unit	Returned data type	Status	Availability
Microphone	--	--	--	Sound	--	Taken
GPS	GLONASS	--	--	GPS coordinates	--	Free
Accelerometer	--	--	--	Acceleration	--	Free
Gyroscope	--	--	Degrees	Angular position	--	Free
Heart-rate sensor	--	--	BPM	Heart frequency	--	Free
Barometer	--	--	Pa	Atmospheric pressure	--	Free
Battery	Li-Ion	380	mAh	Charging Level	35%	Free
Processor	Dual-core	1.0	GHz	Processing power	80%	Free
RAM	--	768	MB	Memory usage	300	Free
Storage	--	4	GB	Storage capacity	1.5	Free
Network	Wi-Fi	802.11	--	Bandwith	--	Free
Display	Super AMOLED	1.3	inches	--	--	Free
Audio	--	--	--	Sound	--	Taken
Vibration	--	--	--	--	--	--

#### 4.2. Service composition model and component requirements

LLA services are expected to run on connected rich environments. Therefore, they should be mobile, adaptable, and most importantly modular. The mobility aspect is ensured by the Kalimucho middleware. The adaptability aspect comes from the awareness of the devices that host these services. The modularity aspect is ensured by the de-composition aspect that we propose. Indeed, LLA services, are composed by Kalimucho components that are mutually exclusive and atomic and who communicate only by exchanging relevant data.

Furthermore, each component has hardware requirements in order to run as expected. These requirements are related to the nature of the task and the category of the component.

#### 4.2.1. Service Composition

Using the same logic as the global architecture of LLA, the service is composed of three main categories of components (see Figure 53).

**Input Components:** These components act as extractors of data from devices, sensors, or from the user's physical input (keyboard, click). They can either run in the background if no interaction is needed or be joined to LLA's UI if the user's input is needed (back-end/front-end).

**Core components:** These components require usually heavy processing because they coordinate the service's overall workflow and execute the most important tasks. These components always run in the background (back-end) never to be seen by the user.

**Output Components:** These components are what the user expects to see (front-end) when his/her context changes. They are the interface of the service and they join the LLA's main UI as an incorporated feature into the application. They are removed from the interface when the context changes or when the user stops the service manually. Stopping them manually will stop the entire service.

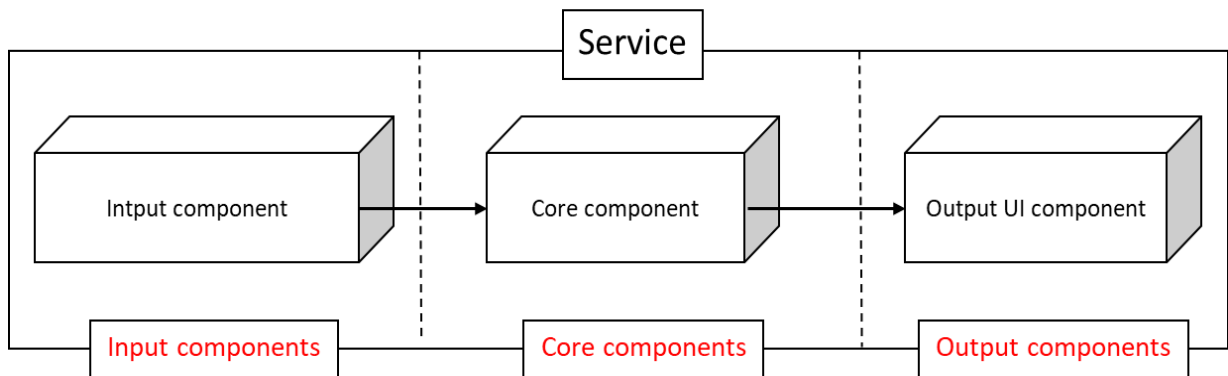

Figure 53 - Service composition architecture

Nonetheless, it is not mandatory to have all three kinds of components in the same time for the service to be able to run. Some services, like reminders and notifications, for example, require only an output.

### 4.2.2. Component requirements

Due to the different tasks performed by the components, the hardware requirements vary greatly. For each category of components, LLA focuses on a specific set of requirements. In order to present this into LLA, the general query rule is:

- **!Resource**: This query means that the component request and needs the presence of a specific resource. For example, “!GPS” means that the device should have a GPS in order to run that component.

We use the following query rules for static capabilities:

- **S!Resource = “M”**: This query means that the component request and needs the presence of a specific resource with the specific model M.
- **S!Resource >, <, >= or <= Power unit**: This query means that the component request and needs the presence of a specific resource and preferably with a power value greater than a value (Power unit). For example, “(S!Processor = ARMv7) > 1.5Ghz” or “S!DISPLAY < 12inch” .

For dynamic resources, which can change their status during runtime, LLA understands the following rules:

- **D!Resource >, <, >= or <= Status unit**: This query means that the component request the presence of a specific resource that has the required status. For example, “D!Ram>200MB” means that the device should have a RAM which has more than 200MB of free memory.
- **D!Resource is Free**: This query means that the component needs a resource which is either free or taken.

These rules consider binary “&” and “||” binary operations. For example, if the component requires the presence of a camera and 4GB RAM, the rule is defined like: ((!Camera)&(s!RAM > 4GB)). The different categories of components have a variety of requirements.

Firstly, input components focus on extracting data from devices which makes them require the presence of a specific set of resources. The data could be in any format (video, sound, text, etc.) and extracted from any device meeting the requirements. Therefore, we identified 2 categories of hardware requirements:

- *Service related:* Camera, Microphone, Keyboard, Mouse, Fingerprint scanner, and GPS.
- *Sensor related:* Accelerometers, Gravity Sensors, Gyroscopes, Rotational Vector Sensors, Barometers, Photometers, Thermometers, Orientation Sensors, Magnetometers, Heart rate, etc.

Secondly, core components focus on running the heavy calculations and handling the most important components of the service. Therefore, they consider, most importantly, the hardware specification related to calculation time and space. For these components, we identify the following requirements:

- *Battery:* Even though having a battery is not mandatory for all devices (e.g. computer), for portable devices this feature is useful in knowing the level of charge and therefore knowing the state of the device.
- *Processor:* These components ask the device for their processor's type, capacity in terms of processing power and current status.
- *RAM:* For components that require an important amount of memory usage, this resource is very important.
- *Cache:* This requirement represents the ability to store data so future requests for that data can be served faster; the data stored in a cache might be the result of an earlier computation or the duplicate of data stored elsewhere.
- *Storage:* Some services might require storing data on the device thus the need for a physical memory storage.
- *Network:* This feature presents the connectivity options on the device.
- *Graphics:* For components with 3D animations, like video games, for example, this feature could be required and helpful.
- Finally, output components focus on running UI and other forms of feedback like sound and vibrations. Since LLA is running in a distributed environment that might be filled with different devices, choosing the best form of feedback is an important factor to ensure a fluent and interesting user experience. For these components, we identify the following requirements:
- *Display:* This is the main feature for interacting with the user. The devices possessing a screen will host the UI of LLA and the services.



- *Audio*: For components that require an audio output, this requirement is very important.
- *Vibration*: Most devices, nowadays, are able to vibrate. Therefore, this is considered an important type of feedback.
- *LED*: This is the most primitive, yet still used, type of feedback. Illuminating a led in a different color could be a good indication of the type of feedback.
- *OTHER*: This category is for any other non-conventional format of output like, for example, temperature coming from a connected heating system.

The service composition and requirements are specified by the developer of the service and added in the description of the service in the *Services description & requirements* file in the persistence layer (see Chapter 3). The description is presented both textually and graphically.

**Graphically**: The graphical representation is used to have a clearer understanding of the composition strategy for the service (see Figure 53).

**Textually**: A description for service is presented textually in the following format.

**Service**: [*Input* [*Component* (*Component requirements &,||...*); ...]; *Core* [...]; *Output* [...] | *Links* (*ComponentN -> ComponentN+1;...*)]

For example, a video chat service (see Figure 54) that uses our modular composition would contain 5 components: Picture feed component, Sound feed component, Text feed component, Video chat core component, and Video chat UI component.

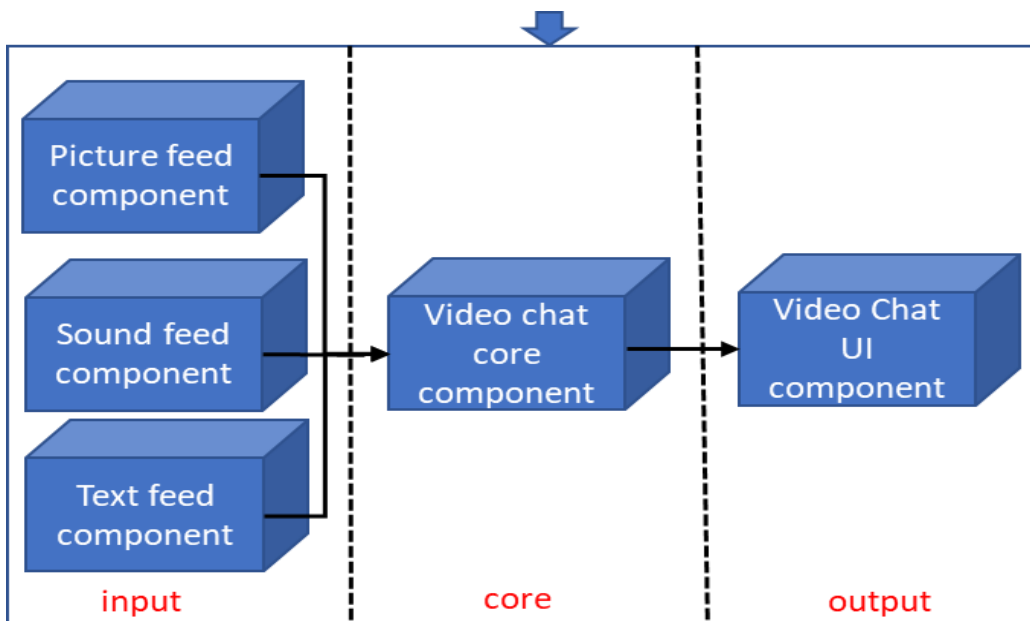

Figure 54 - Video chat service composition graphical representation

Textually, this service is presented as follows:

*Video chat service: [Input [Picture feed component (!Camera); Sound feed component (!Microphone); Text feed component (!!Keyboard)||(!Display)]; Core [Video chat core component (D!RAM>1GB)]; Output [Video chat UI component (S!Display>10inch);] | Links (Picture feed component -> Video chat core component; Sound feed component -> Video chat core component; Text feed component -> Video chat core component; Video chat component -> Video chat UI component;)]*

These components are linked to each other, via Kalimucho connectors, yet work separately on their specific tasks in order to form the overall behavior of the service. Naturally, these components have hardware requirements that the devices need to provide in order for the service to be executed in a functional state.

### 4.3. Matching services to situations

In LLA, for each situation, a mapping is considered. The mapping matches situations to services in order to respond to contextual changes when needed. Using the service composition and component requirement concepts, the matching defines clearly the needs of the service in terms of optimal distribution. A mapping M is presented textually in the following format, where P is a projection and Sn is a situation.

$$M : S_n [ P(1..n) [ Service; ...]]$$

In the persistence layer (see Chapter 3), these textual representations are translated into XML and injected into the user's application (Mapping) in order to define his/her responses to the detected situations.

Having defined the service layer (see Chapter 4), we have the full description of the situation (context and service). For example, in figure 55, a graphical full description is shown. This representation shows an example of an important (P(2)) monthly work meeting situation done remotely using a video chat service.

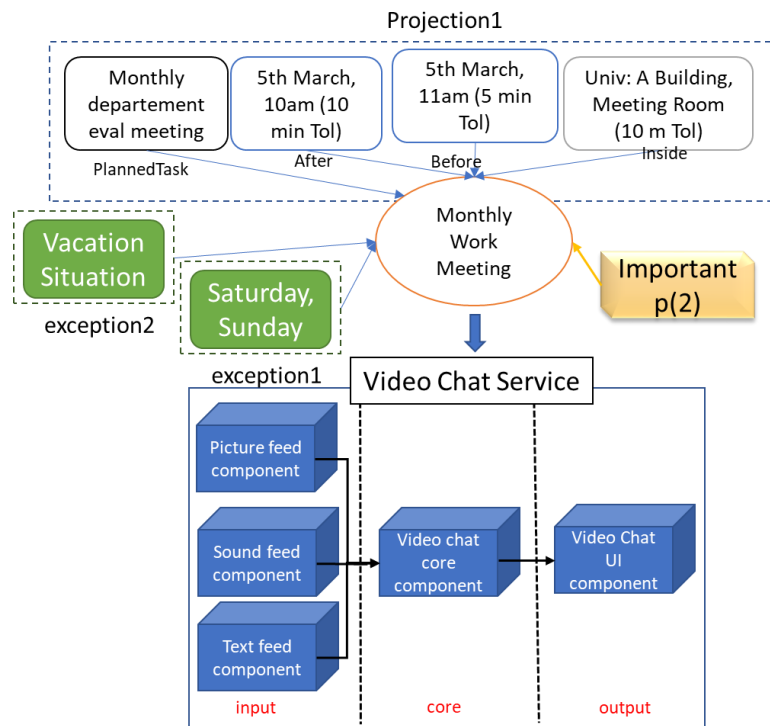

Figure 55 - Monthly Work Meeting full representation

Using the same video chat service example (see Figure 55), the textual representation of the mapping is as follows:

*M1: Monthly work meeting [Projection1 [Video chat service]]*

This indicates that when the Monthly Work Meeting situation is detected and is about to start, LLA will deploy the video chat service. If the situation is ending, LLA stops the service by stopping all its components.

#### 4.4. Orchestration and control components

After explaining the concepts related to service composition, situation mappings, and device capabilities, the focus of this part is to define the internal components that work inside the Action Orchestrator and ACL filter. These components use the defined concepts (Mappings, Service descriptions, Requirements, Device capabilities, and User-Domain) in order to launch or stop the services needed in the best way possible while taking into account their requirements and the status of the user-domain.

This internal architecture, represented in Figure 56, is composed of multiple components each performing a task separately and simultaneously while communicating the results to each

other. The Parser is the module enabling these components to access the data stored in the files in the persistence layer.

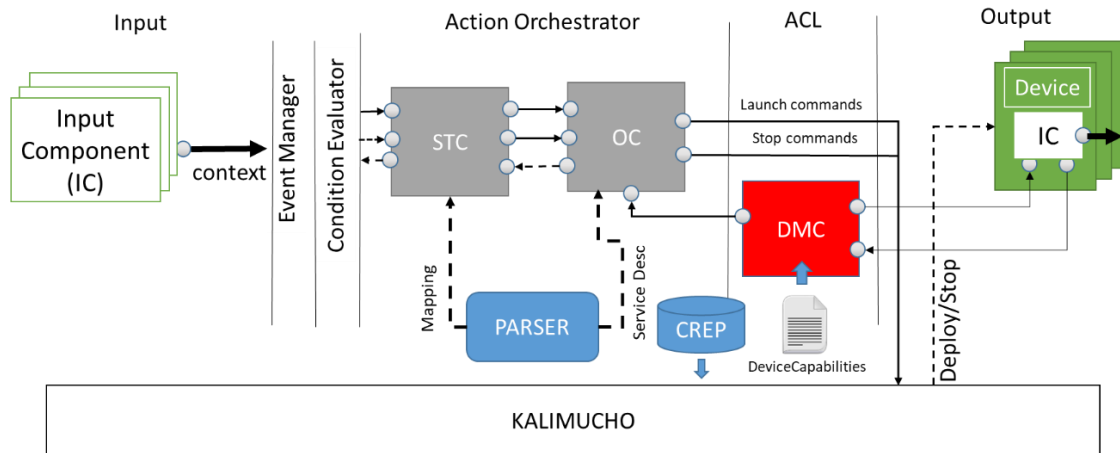

Figure 56 - AO and ACL internal architecture

The process of orchestrating services starts by receiving the results of the previous module (CE). Using these results, it adapts LLA to the needs of the user by stopping and starting services.

#### 4.4.1. Situation Tracker Component (STC)

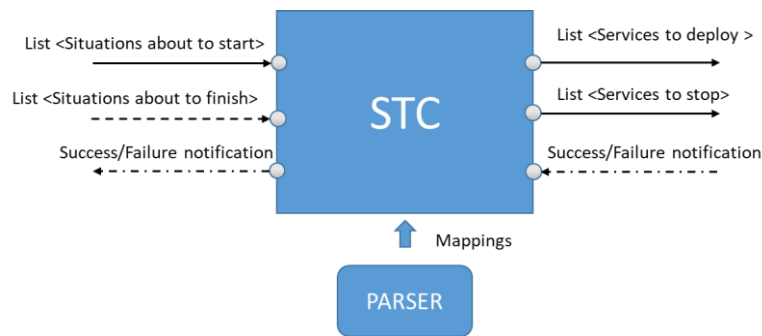

Figure 57 - Situation Tracker Component

This component (see Figure 57) keeps track of all the situations that are currently running. It consults the mapping file in order to know how to respond to a certain situation.

It takes as input the list of situations that are able to start (organized according to their priorities). It receives also from the Situation Manager component a list of ending situations. It consults the mappings, received from the Parser, and then identifies the service that needs to be started and stopped. For each starting services that this component sends to the Orchestrator component, it receives a success/failure notification indicating if that service was successfully

deployed on the user’s devices. When this notification is received, this component sends it to the previous component, which is the Priority Component (CE module).

#### 4.4.2. Orchestration Component (OC)

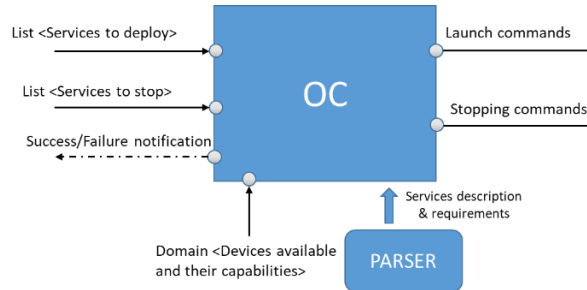

Figure 58 - Orchestration Component

This is the main component (see Figure 58) that will shape LLA into the application that the user requires and expects. It orchestrates how the application will run in the user-domain (devices). It takes the list of components to deploy and those to stop. It also takes in the list of available devices, their capabilities, and their accessibility.

According to the requirements of the components about to be launched, it chooses the best fit device to host that component. These choices make the orchestration of the application around the user optimal. As output, it sends deployment and stopping commands (see Appendix 1) to the Kalimucho platform.

For launching commands, Kalimucho fetches the required component firstly in the local CREP (Component Repository), Secondly in the CREP of the other devices accessible to the user (domain) and finally on the cloud layer. For stopping commands, Kalimucho simply stops the components.

#### 4.4.3. Device Management Component (DMC)

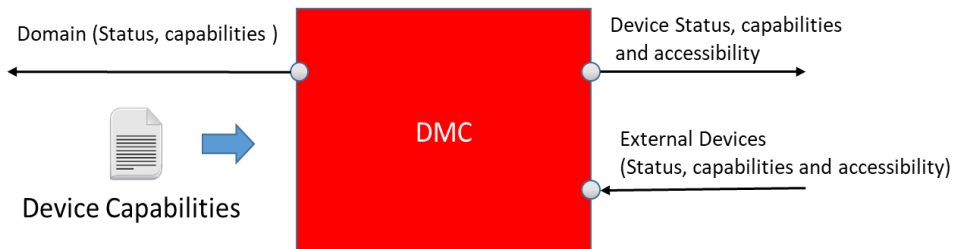

Figure 59 - Device Management Component

This component (see Figure 59) scans the domain and receives the status, capabilities, and accessibilities of all the other devices around the user. It considers the same things for the internal device hosting this instance of the platform. It sends the information about the internal device to the other devices in the domain.

#### 4.4.4. Example

In order to demonstrate how the Action Orchestrator and ACL filter both work, we study a portion of the example described in Figures 60. The focus on this example is to show the evolution of actions of LLA by adding and removing services on multiple devices.

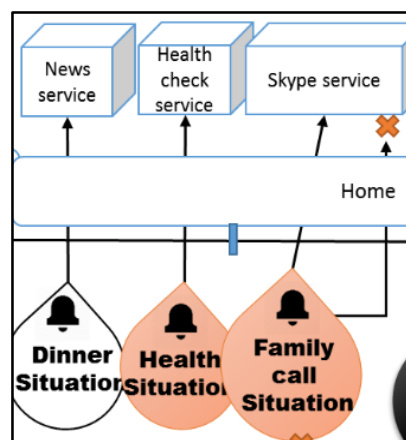

Figure 60 - Scenario portion

The considered situations all happen consecutively while the user is at home. For each one, LLA deploys different services and closes others. The mapping for these situations is textually represented as follows.

```

** M1: Dinner Situation [Projection1 [News service]]
** M2: Health Situation [Projection1 [Health check service]; Projection2 [Medicine
Reminder Service]]
** M3: Family Call Situation [Projection1 [Skype service]]

```

The service description for these mappings is textually represented as follows.

```

**News Service: [Input [Remote Control component ((S!Display>=5inch)&
(S!Network=Infrared\\Bluetooth\\Wifi))]; Core [News Stream component (S!RAM>2GB;
S!Network=Infrared&WiFi)]; Output [Image output component (S!Display>28inch); Sound
output component (S!Audio>50dB)] | Links [Remote Control component -> News Stream
component; News Stream component -> Image output component; News Stream component -
> Sound output component)]

**Health Check Service: [Input [Health data collector component ((!Heart rate sensor)&
(!Accelerometer)&(!Gyroscope))]; Core [Health data analyzer component (D!RAM>1GB)];
Output [Results component (S!Display>5inch)] | Links (Health data collector component ->
Health data analyzer component; Health data analyzer component -> Results component;)]

**Medicine Reminder service: [Output [Results component (!Display;)]]

**Skype service: [(Input [Picture feed component (S!Camera="CMOS-High Def"); Sound
feed component (!Microphone); Text feed component ((!Keyboard)||(!Display))]; Core [Skype
core component (D!RAM>2.5GB)]; Output [Image output component (S!Display>16inch);
Text UI component (S!Display>10inch); Sound output component (S!Audio<40dB)] | Links
(Picture feed component -> Skype core component; Sound feed component -> Skype core
component; Text feed component -> Skype core component; Skype core component -> Image
output component; Skype core component -> Sound output component; Skype core component
-> Text UI component;)]

```

Graphically, the service layers of these situations are represented in Figure 61.

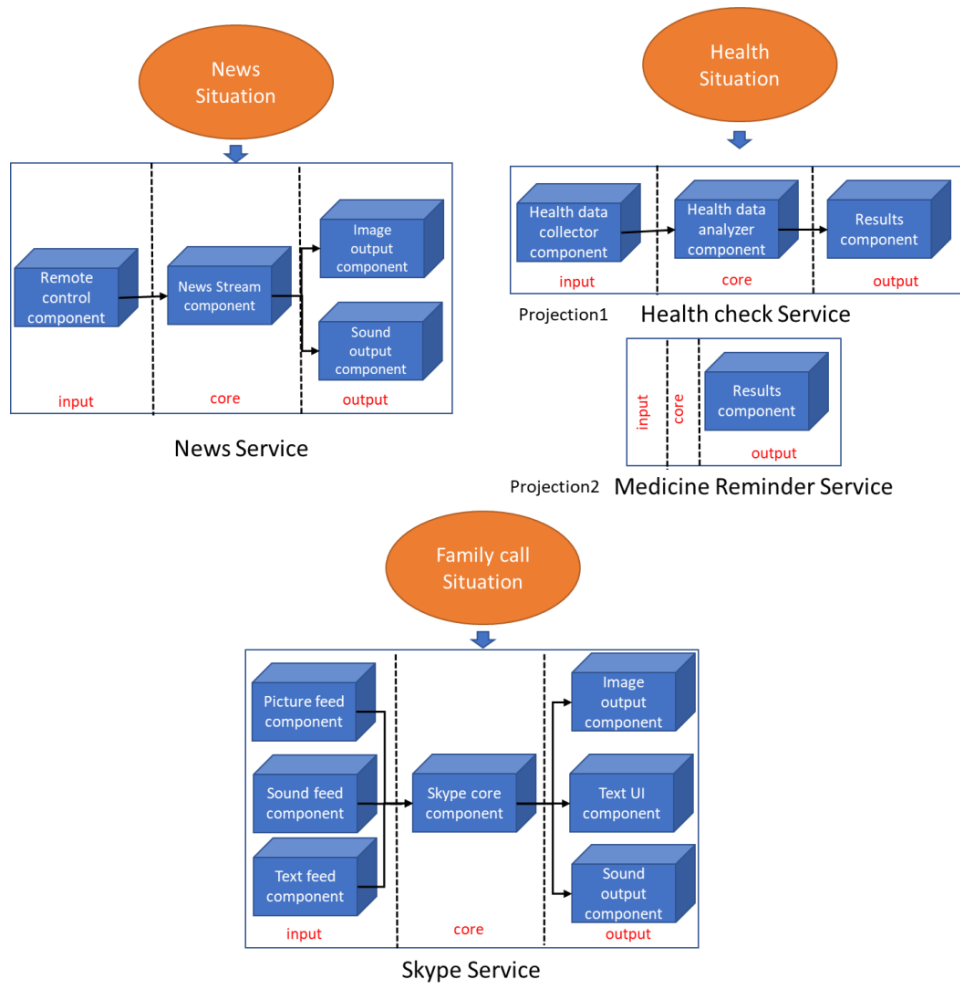

Figure 61 - Situations service layers



Table 14: Example of User-Domain

Device	Capability	Model	Power	Unit	Returned data type	Status	Availability
Samsung Gear S3	See Table 13.						
HP Envy Laptop [54]	Processor	Intel® Core™ i7-7500U-Dual	3,5	GH z	Processing power	90%	Free
	RAM	DDR4	12	GB	Memory usage	6.8	Free
	Storage	SSD	256	GB	Storage capacity	160	Free
	Camera	--	8	MP	Photo/Video	--	Free
	Display	--	15,6	inc hes	--	--	Free
	Keyboard	--	--	--	Text	--	Free
Home audio system [75]	Audio	Pro 7.1Ch 400W	104	dB	Sound	--	Free
	Display	--	2	inc hes	--	--	Free
	Network	Wi-Fi, Infrared, Bluetooth	--	--	--	--	Free
Sony KDL-43W805C Smart-TV [93]	Display	X-Reality	43	inc hes	--	--	Free
	Network	Wi-Fi, Infrared, Bluetooth	--	--	--	--	Free
	Audio	--	40	dB	Sound	--	Free
Microsoft Kinect 2 [69]	Camera	CMOS- High Def	3.5	MP	Photo/Video	--	Free
	Color, Tilt, Depth sensors	--	--	--	--	--	--

	Microphone	--	--	--	Sound	--	Free
Samsung Galaxy S4 [46]	Microphone	--	--	--	Sound	--	Free
	Camera	Back, Front	12, 2	MP	Photo/Video	--	Free
	GPS	--	--	--	Coordinates.	--	Free
	Battery	Li-Ion	2600	m Ah	Charging Level	80%	Free
	Processor	Octa-core (Cortex-A15, Cortex-A7)	1.2&1.6	GHz	Processing power	90%	Free
	RAM	--	2	GB	Memory usage	1,2	Free
	Storage	--	16	GB	Storage capacity	3.2	Free
	Network	Wi-Fi, Infrared, Bluetooth, NFC	--	--	--	--	Free
	Display	Super AMOLED	5	inches	--	--	Free
	Audio	--	30	dB	Sound	--	Free

When these situations happened (initial state), the user is in his/her home where he/she has a user-domain (Domain 1) of devices represented in Table 14. In this table, all the devices are private to the user and we only present the features interesting for the example around the time when the Dinner situation is detected. Table 15 presents the evolution of the orchestration process through the component considering the available devices and required capabilities. It shows the inputs and outputs of the AO and ACL components. In table 13:

- Domain 2 and Domain 3 both contain the devices presented in Table 14. They represent the evolution/changes (new device detected, a device left the domain, etc.) of Domain1 that the LLA started with. These changes affect also the dynamic and concurrency capabilities (see 1. Device Capabilities).
- The success and failure notification row is represented using two columns because of the delay in receiving back the notification

Table 15: Situation analysis by the Event Manager's components

<b>STC</b>	<b>Inputs</b>	<b>Situations about to start</b>	Dinner Situation (projection1)		Health Situation (projection1)		Family call Situation	
		<b>Situations about to finish</b>	--		Dinner Situation		Health Situation	
		<b>Success/failure notification</b>	--	Dinner situation Success	--	Health situation Success	--	Family call Success
	<b>Outputs</b>	<b>Services to deploy</b>	News Service		Health Check Service		Skype Service	
		<b>Services to stop</b>	--		News Service		Health Check Service	
		<b>Success/failure notification</b>	--	Dinner situation Success	--	Health situation Success	--	Family call Success
<b>DMC</b>	<b>Inputs</b>	<b>Other Devices cap, access</b>	Devices in domain 1		Device in domain 2		Devices in domain 3	
	<b>Outputs</b>	<b>Domain (device list)</b>	Domain1 (see Table 14)		Domain 2		Domain 3	
		<b>Device status, cap, access</b>	HP Envy Laptop		HP Envy Laptop		HP Envy Laptop	
<b>OC</b>	<b>Inputs</b>	<b>Domain</b>	Domain 1		Domain 2		Domain 3	
		<b>Services to deploy</b>	News Service		Health Check Service		Skype Service	
		<b>Services to stop</b>	--		News Service		Health Check Service	
	<b>Outputs</b>	<b>Success/failure notification</b>	Dinner situation Success		Health situation Success		Family call Success	
		<b>Launch commands</b>	Commands 1		Commands 2		Commands 4	
		<b>Stopping commands</b>	--		Commands 3		Commands 5	

The most interesting output of this module comes from the OC, which launches the commands that can be interpreted by the Kalimucho middleware in order to start and stop components on the appropriate devices. In the following, we present the commands required in order to orchestrate the services on the user-domain after selecting the best eligible devices.

- Commands 1 (deploying the News Service):

```
SamsungGalaxyS4 : CreateConnector RCC SamsungGalaxyS4 HpEnvyLaptop
HpEnvyLaptop ; CreateConnector IOC HpEnvyLaptop SonyKDL
HpEnvyLaptop : CreateConnector SOC HpEnvyLaptop HomeAudioSystem

SamsungGalaxyS4: CreateComponent RemoteControl
application.BBC.News.Input.RemoteControlBC [null] [RCC]

HpEnvyLaptop: CreateComponent NewsStream
application.BBC.News.Core.NewsStreamingBC [RCC] [IOC SOC]

SonyKDL: CreateComponent ImageOutput
application.BBC.News.Output.VideoPlayerBC [IOC] [null]

HomeAudioSystem: CreateComponent SoundOutput
application.BBC.News.Output.SoundPlayerBC [SOC] [null]
```

Compared to Domain 1, Domain 2 contains the same devices. The first change is that the availability of the Audio capability of the *HomeAudioSystem* is changed to Taken after launching the News service. The second change is on the status level of the *HpEnvyLaptop*'s RAM and Processor capability. After deploying the *NewsStream* component, which takes an amount of memory and processing power, the status values are changed.

- Commands 2 (deploying the Health Check Service):

```
SamsungGearS3 : CreateConnector HDC SamsungGearS3 HpEnvyLaptop
HpEnvyLaptop : CreateConnector HSC HpEnvyLaptop SonyKDL

SamsungGearS3: CreateComponent HealthDataCollector
application.HospitalBayonne.Karchoud.Input.DataCollectorBC [null] [HDC]

HpEnvyLaptop: CreateComponent HealthDataAnalyzer
application.HospitalBayonne.Karchoud.Core.DataAnalyzerBC [HDC] [HSC]
```

```
SonyKDL: CreateComponent HealthStatus
application.HospitalBayonne.Karchoud.Output.ResultsBC [HSC] [null]
```

- Commands 3 (stopping the News Service):

```
SamsungGalaxyS4 : RemoveConnector RCC
HpEnvyLaptop : RemoveConnector IOC
HpEnvyLaptop : RemoveConnector SOC
SamsungGalaxyS4: RemoveComponent RemoteControl
HpEnvyLaptop: RemoveComponent NewsStream
SonyKDL: RemoveComponent ImageOutput
HomeAudioSystem: RemoveComponent SoundOutput
```

The change in Domain 3 happens on the availability level of the Audio capability of the *HomeAudioSystem* is changed back to Free after stopping the News service. The RAM and Processor statuses are also affected accordingly. The *HealthDataAnalyzer* affects also the RAM and Processor of the *HpEnvyLaptop*.

- Commands 4 (deploying the Skype Service)

```
MicrosoftKinect1520 : CreateConnector PFC MicrosoftKinect1520 HpEnvyLaptop
HpEnvyLaptop : CreateConnector SFC SamsungGalaxyS4 HpEnvyLaptop
HpEnvyLaptop : CreateConnector TFC HpEnvyLaptop HpEnvyLaptop

HpEnvyLaptop : CreateConnector TUIC HpEnvyLaptop HpEnvyLaptop
HpEnvyLaptop : CreateConnector IOC HpEnvyLaptop SonyKDL
HpEnvyLaptop : CreateConnector SOC HpEnvyLaptop SamsungGalaxyS4

MicrosoftKinect1520: CreateComponent PictureFeed
application.Skype.Input.PictureFeedBC [null] [PFC]

SamsungGalaxyS4: CreateComponent SoundFeed
application.Skype.Input.SoundFeedBC [null] [SFC]

HpEnvyLaptop: CreateComponent TextFeed
application.Skype.Input.TextFeedBC [null] [TFC]

HpEnvyLaptop: CreateComponent SkypeCore
application.Skype.Core.SkypeCoreBC [PFC SFC TFC] [IOC TUIC SOC]
```

```

SonyKDL: CreateComponent ImageOutput
application.Skype.Output.ImageOutputBC [IOC] [null]

SamsungGalaxyS4: CreateComponent SoundOutput
application.Skype.Output.SoundPlayerBC [SOC] [null]

HpEnvyLaptop: CreateComponent ChatUIOutput
application.Skype.Output.ChatUiBC [TUIC] [null]

```

- Commands 5 (stopping the Health Check Service) :

```

SamsungGearS3 : RemoveConnector HDC
HpEnvyLaptop : RemoveConnector HSC
SamsungGearS3: RemoveComponent HealthDataCollector
HpEnvyLaptop: RemoveComponent HealthDataAnalyzer
SonyKDL: RemoveComponent HealthStatus

```

After Kalimucho runs Command 4 and Commands 5, Domain 3 has the following changes: the availability of the Sound and Microphone capabilities of *SamsungGalaxyS4* is changed to Taken; the availability of the Camera capability of *MicrosoftKinect1520* is also changed to Taken.

## 5. Conclusions

User preferences and user experience are major factors that developers and designers should consider when implementing their applications if they want to keep up with the evolution of the user's connected world and evolving needs.

LLA incorporates a mechanism that enables the user to have a better, distributed, and hands-free experience using a distributed adaptable service layer tailored to his/her specific needs and hardware limitations.

In our proposal, we highly consider the user's status and conditions by incorporating a Lock Zone approach capable of filtering the user's possible situations according to his/her current availability status (free, busy, etc.). We also provide a dynamic priority management feature that handles the concurrency of situations and organizes them while considering their own importance level, the user's status, and their sources importance level.

These sources are presented in the next chapter, which is dedicated to showing how LLA enables furthermore dynamicity by offering a new concept called context injection.

---

---

*Chapter 7 – Situation Injection Mechanism*

---

### 1. Introduction

A major issue with mobile applications in general and context-aware applications, in particular, is their repetitiveness and limitation to restricted application domains or closed spaces equipped with sensors [52].

With the aim of overcoming this issue, the LLA application handles a semi-automatic, collaborative, open injection mechanism that continuously provides the user with richer contextual awareness and more suitable services. In this way, we ensure the continuous growth of LLA by making it able to enhance and enrich the user experience by managing (adding, deleting, or modifying) new situations introduced through the injection mechanism. This mechanism is based on a user-friendly situation model in order to make the injection an easy and understandable procedure that can be performed even by end-users with no understanding of technical issues.

The injection mechanism has multiple sources of injection and communicates directly with the persistence layer of the application.

### 2. Situation injection mechanism

One main novelty of LLA is a collaborative mechanism [62] that enables users and other external sources to continuously and proactively introduce new situations into the user's application, in order to improve its understanding and reliability and overcome the lack of dynamicity in current context-aware applications.

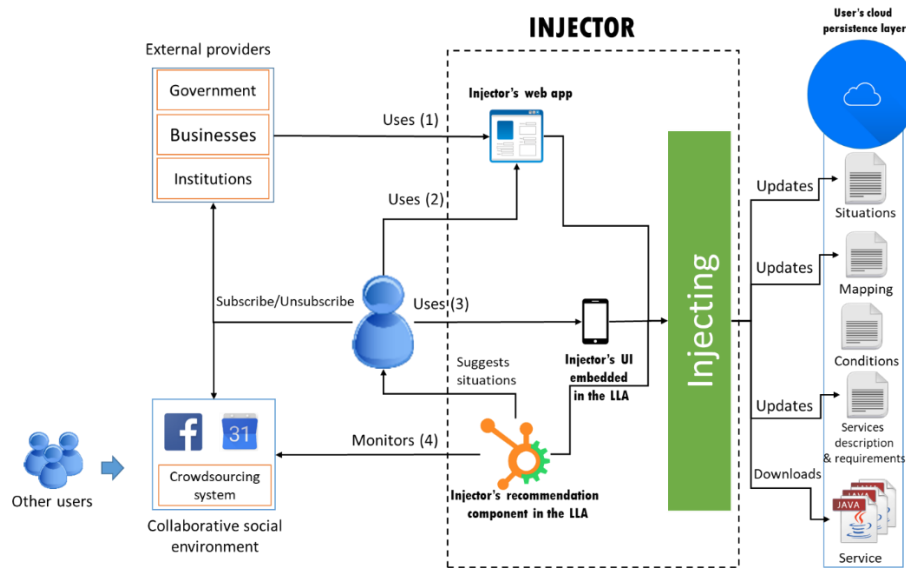

Figure 62 - The Injector's workflow



The injector acts as an input (inserter) dedicated to enriching the context awareness considered for the user from diverse sources. It can inject/modify/delete/update situations and/or services without having to access directly the devices of the user. These sources can inject the situation's description into the user's app by interacting with the persistence layer of the user (see Figure 62). The data of this layer is stored in a cloud storage and is shared among all the user's devices. This solution avoids redundancy and inconsistencies among user devices regarding his/her situations in order to keep the coherence of LLA.

One benefit of using this high-level contextual injection mechanism, which extracts context data from multiple sources, is the capability to provide a way of increasing continuously the repository of monitored situations and thus be more customized to the user.

The LLA needs to be aware of the user's habits, needs, and social environment. Three main categories of context injection sources are considered by the application. Each main source of injection uses a different process to collaboratively update the application of the user in a transparent way that does not require any unnecessary downloads.

The advantage of this mechanism resides in eliminating the time and network usage usually needed, by current existing applications, to do regular heavy updates for even the simplest changes in the code base. Using our approach, the updates will be occasional and probably affect only the situation's file or the mapping file by using already-stored components. Even on the service level, developers will be able to modify components separately and therefore have fewer and lighter updates.

### **2.1. User's Injection Process**

The first source of situations is the user himself/herself, and more precisely his/her needs and habits. What motivated us to propose this is the repetitiveness that users feel while they set their alarm every night or while they open their emails every morning. These habits can be automated in order to help the user to have the same experiences without having to always perform those same tasks again and again.

To do so, the user has the possibility to use either the injector's UI, which is accessible from his/her LLA's Manager UI (mobile version) or the Web Injector. In the first case (see Figure 62 "Uses (2)"), the mobile injector is dedicated to building simple and fast situations by working on only 1 projection and 3 axes per situation.

In the second case (see Figure 62 "Uses (3)"), the web application allows a more precise and rich description of situations and services using multiple projections and 6 axes.

In both cases, the user can either create, delete or modify a situation by inputting/modifying the required values (like the time, location and activity) and then update or create a matching by selecting a service or a set of services to be deployed when the situation is detected. The user can also decide to share these situations with other users.

After selecting the service/services, the user verifies if the components composing the selected service exist in his/her repository. A possible extension from this end would be to have a store for services instead of applications, where users can select services to download into their local or cloud storage in order to use them willingly when needed. Nonetheless, if the user wishes for the required service to not stay on his/her storage space, he/she could specify to trigger the download only when the situation is detected and ask to be deleted when that situation finishes.

Finally, the user has the possibility to subscribe to, or unsubscribe from, other injection sources freely, giving these sources the possibility to provide him/her with new situations, mappings, and services.

## 2.2. Collaborative Social Environment's Injection Process

Social media has become the largest source of information about users' activities, preferences, etc. Moreover, we live nowadays in the age of media sharing.

In this scope, the injector incorporates into the LLA's architecture a transparent component running in the background, which monitors the user's social media (if the user subscribes to it and allows this monitoring) in order to suggest/recommend new situations.

In order to build these suggestions, the injector follows a specific process (see Figure 62 ``Monitors (4)'). After extracting events and birthdays from Facebook, tasks from Google Calendar, etc., the injector mechanism asks the user to specify the tolerance and the expected reaction to these potential situations. The user can select services from the *Services Repository* to be deployed automatically when the situation is detected.

If the monitor detects a new shared situation coming from another user, it suggests it to the user and allows him/her to choose whether to download the services that other users recommend for that specific situation or select his/her own services. Otherwise, if the user does not specify any reaction strategy, the application creates a situation and assigns a reminder service by default. This widens the applicability of contextual engagement by giving the user the possibility to create/share his/her own situations or extract them automatically from his/her social environment (using data from Facebook, Google Calendar, Twitter, etc.).

For example (see Figure 63), if the user received an invitation to a concert event on Facebook (Tuesday 25<sup>th</sup> July 2017 at Bayonne Center) and he/she chooses to participate, the injector's recommendation component, which is monitoring the user's social media, detects this event, builds a situation, and proposes to the user to add it to his/her own situations; then, the user accepts this situation; finally, he/she also selects a ticket provider service and a video streaming service that he/she wishes to use when the concert situation happens.

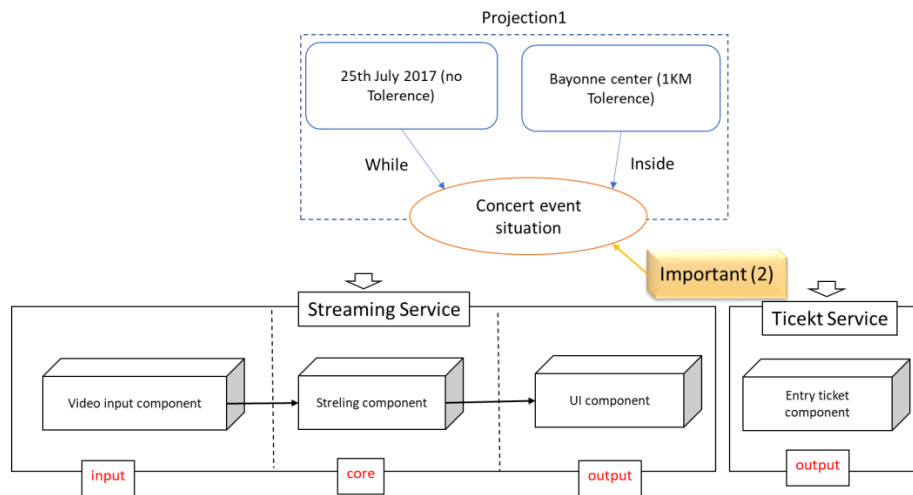

Figure 63 - Concert event situation

### 2.3. External Providers' Injection Process

This is a very important source of injection in this proposal, as it completes the mechanism with an open system that can provide endless possibilities to the user by continuously proposing new situations and services. Whereas the other sources of injection (user and social) handle private and social situations, this source covers a wider range of situations related to a variety of domains that otherwise could not be considered. The providers are external sources that the user can subscribe to in order to allow them to inject his/her application with situations and provide him/her with services.

For these sources, the process of injecting situations (see Figure 62 ``Uses (1)`) is done with the help of the web application. Providers can create situations (like users), and then select among their subscribers the ones that are concerned by that situation. Nonetheless, they should implement their own services and components using the Kalimucho framework. Finally, the injector broadcasts those situations, mappings, and services, to the concerned users.

The situations and mappings are described via a web application and then injected to the subscribers of the provider along with the appropriate services (software components). The providers are classified into three main categories;

### 2.3.1. Government providers

The first category is formed by government organisms and services (universities, hospitals, the police, etc.). If the user subscribes to these organisms, he/she allows them to inject situations.

For example (see Figure 64), if the police decide to close the borders due to an emergency, it injects that situation to all the users in the vicinity, in order to notify them and propose another road when the user gets close to the borders on that specific date.

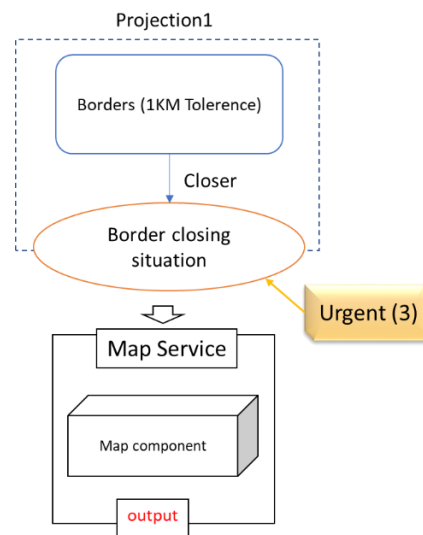

Figure 64 - Border closing situation

### 2.3.2. Businesses and private companies

Any business (MacDonald, Carrefour, a gas station, etc.) can offer its situations and allow users to subscribe and use its services. Considering other applications that use context awareness to aim advertisements for users, our proposal provides a new way to engage those users, not limited to texts and notifications but enhanced by the possibility to offer dedicated customizable services instead.

For example (see Figure 65), a parking company can construct and inject a situation into the users' situation repository that, upon detecting that the user entered one of its parking areas,

deploys a parking service to help the user find the closest empty space and remind him/her where he/she parked when he/she gets back to leave.

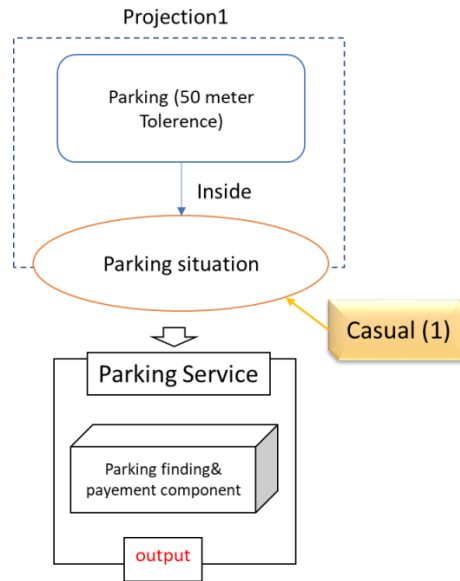

Figure 65 - Parking situation

### 2.3.3. Institutions/Organizations/Associations

These providers represent the non-governmental entities that do not necessarily have a financial gain from the user.

An example (see Figure 66) of this would be a football team that injects training sessions situations to its players' applications. When the defined primitives are verified and service hardware requirements are met, LLA deploys the Biometric Monitor Service.

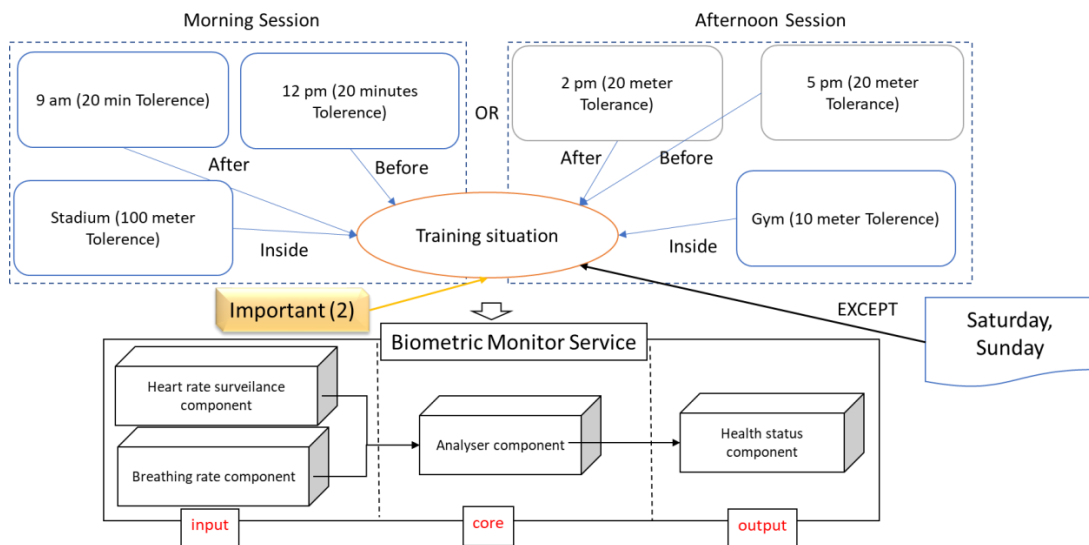

Figure 66 - Training situation

### 3. Conclusions

In a world where users are surrounded by smart objects, fast Internet, and almost-unlimited data storage, users have higher expectations from their apps. Contextual awareness is essential to the survival of mobile applications. However, current context-aware applications have multiple limitations in terms of dynamicity and evolution.

The LLA surpasses these limitations by offering a dynamic injection mechanism allowing users, developers, and other entities, to expand the application and customize it according to the user's needs.

At this level, we already presented how situations are injected, detected, stored and manipulated. The next chapter presents the prototype that we implemented in order to study the feasibility and applicability of our proposal.

---

---

*Chapter 8 – Prototype and Validation*

---

## 1. Introduction

In the previous chapters, we presented our proposal following a sequential order starting by injecting and capturing context and ending by deploying or stopping services. This process is clearly defined (on both a technical and abstract level) step by step which makes following the workflow of LLA a simple task. Moreover, when implementing LLA, we inserted logging events in all the components in order to effortlessly follow the functioning and evolution of the process.

Due to the huge amount of possibilities and parameters considered by LLA, we propose to present the whole process by implementing the scenario described in Chapter 1. This scenario will help to validate our proposal, exhibit our claimed contributions, test the feasibility of our approach, and demonstrate the sustainability of our prototype.

In order to achieve this, we firstly present in this chapter, the evolution of LLA when applied to John's travel scenario. Secondly, we show and discuss the limits, metrics, measures, and results of our proposal.

## 2. Establishing and testing the scenario

When using LLA, users do not have to worry about installing/deleting/updating/configure multiple applications. Nonetheless, for LLA to function properly, some preconditions need to be verified.

In the following sub-section, we present the pre-conditions that John needs to set up in order to LLA to provide him with the expected behavior.

### 2.1. Pre-Conditions

- The most basic pre-condition that needs to be met is, of course, installing LLA on all the devices that the user wishes to use. All the installed instances communicate with each other and work collectively as one application (see Figure 26).
- A newly installed LLA is an empty application. When installing it for the first time, the user should provide a set of information necessary to enable the application to work properly. This set information is the following:
  - User account: Authenticating the user with a Facebook or a Google account (see Figure 67). This authentication will help LLA recognize the user and



synchronize his/her devices and cloud persistence layer. Moreover, linking LLA with Facebook and Google will help the Injector to extract the bio information (age, birthdate, birthplace, picture, etc.), events, and interests of the user which helps the Injector to propose new situations and start to fill the Situations file in the persistence layer.

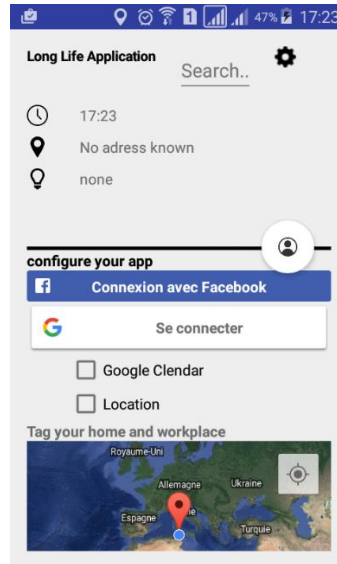

Figure 67 – Authentication UI in LLA

- User private Encryption Key and Device Name: This key is a text provided by the user and used by LLA to discover other instances installed on other devices and to encrypt the exchanged data between them (see Figure 68). The Device Name is an optional value that names the device as the user prefers to name it.

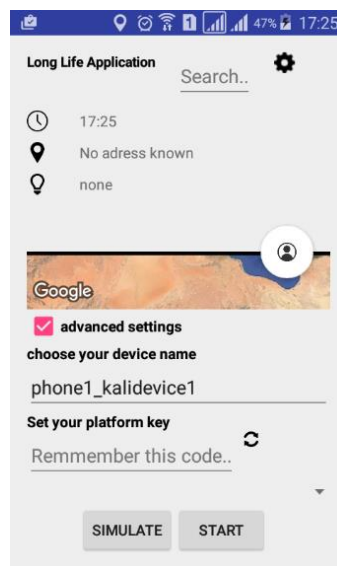
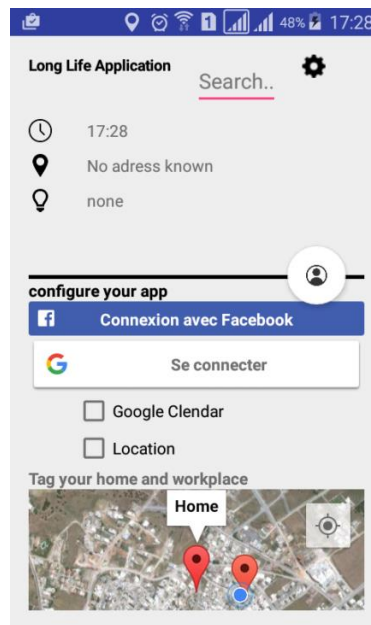

Figure 68 – Defining the encryption key

- Locations: This is an optional input but recommended in order to help LLA understand the user in a more efficient way. The user can define (see Figure 69) geographically some interesting locations related to his/her everyday life (Home, Workplace, School, etc.).



**Figure 69 – Defining home location using LLA**

- Injection Sources: The user should subscribe to sources of situation injections that he/she deems interesting (see Figure 62). This step is optional but recommended if the user wishes to have a richer and more dynamic application. This step can be undone later by unsubscribing from those sources if the user wishes to do so.
- Lock Zones: This step is also optional and can be done (or undone) later in the process. The user can define his/her lock zones (zones that filter the user's situations and manage priorities) and injectors' priorities. By default LLA considers the user to be free.
- Situations: In order for LLA to start reacting to contextual changes, the user needs to either subscribe to external injectors and/or define his/her own basic everyday situations (see Figure 70). Defined situations can be deleted or deactivated later.

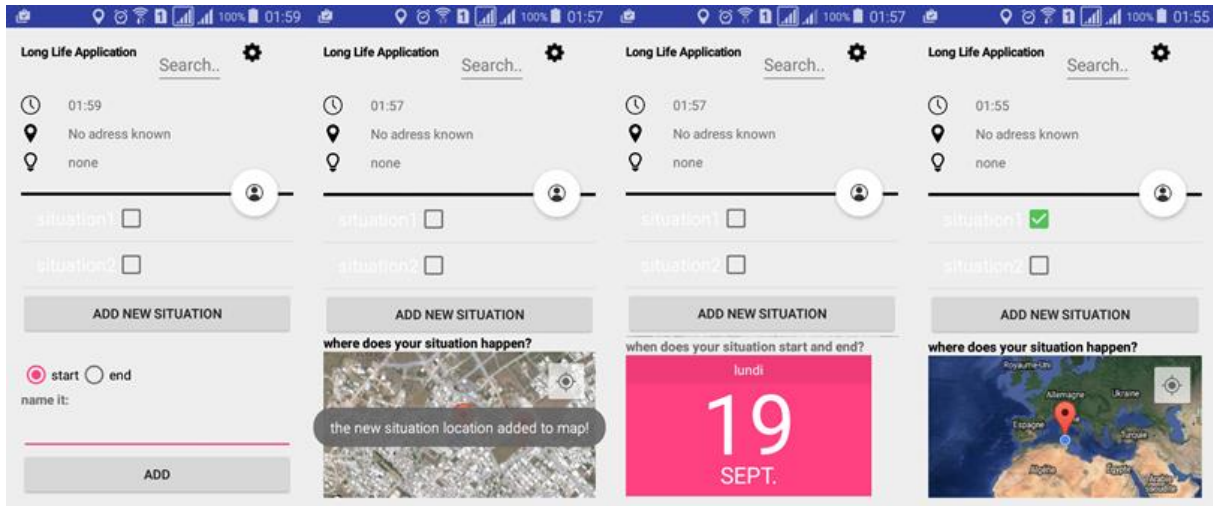

Figure 70 – Adding a new situation using LLA’s UI

- The user should verify the connectivity and stability of his/her devices. Although LLA is able to function off-line, it is highly recommended to keep the devices reachable at all time in order to have a richer user experience and ensure the sustainability and dynamicity of the application.
- Finally, the user has the possibility to select a preferred device to run LLA’s architecture. This device should preferably be the most stable and efficient regarding connectivity and performance. If the user doesn’t specify this device, LLA will dynamically select the most capable device whenever it is started/re-started (see Figure 26).

After verifying these pre-conditions, LLA starts to run continuously to monitor the user’s context and help him/her throughout their everyday life.

## 2.2. John’s travel scenario

Now that our architecture and the concepts of LLA are clearly defined, we take the scenario (see Figure 71) described in Chapter 1 and we apply it to LLA by feeding it all the necessary information in order to have the anticipated behavior. The information presented in this section is all fictitious and is only considered as a simulation.

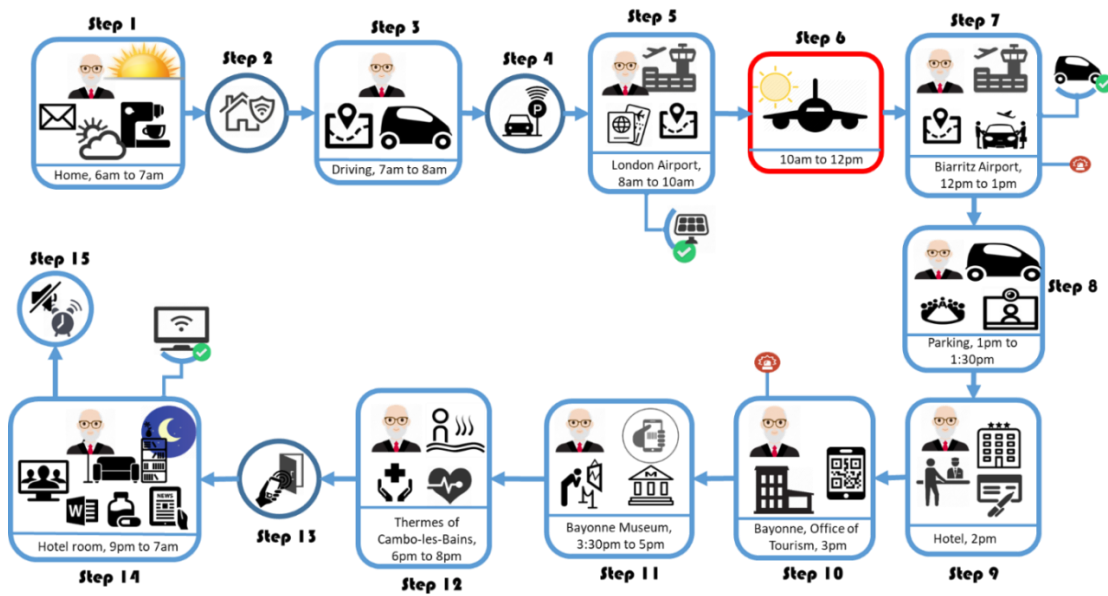

Figure 71 – John’s travel scenario steps

### 2.2.1. John sets-up LLA

To start using LLA, John needs to install it and to verify the stated preconditions.

He, firstly, logs-in using his Google account, allows LLA to access his social environment (Facebook, Google+), and defines his encryption key.

- **Name:** John Brand
- **Age:** 52
- **Birthdate:** 12/03/1965
- **Birth Place:** Yorkshire
- **School:** Cambridge
- **City:** London
- **Country:** Great Britain
- **Job:** Historian/Teacher in University Kingston

John defined the following locations where he frequently goes (see Figure 72 and Table 16).

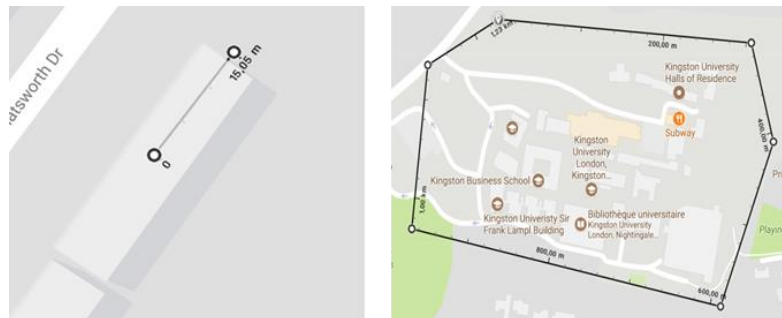

Figure 72- John's defined locations

**Table 16: John's locations data**

<b>Place</b>	<b>Owner</b>	<b>Address</b>	<b>Shape</b>	<b>Coordinates</b>
Home	John	59 Southbury Road London EN1 1PJ	Circle	Center: 51.637818, -0.063590 Radius: 50 meters
University Campus	Public	Kingston University London, Kingston Hill Campus, Kingston Hill, Kingston upon Thames KT2 7LB	Polygon	Point 1: 51.430595, -0.265797 Point 2 : 51.430383, -0.261499 Point 3: 51.428940, -0.261417 Point4 : 51.427568, -0.262367 Point 5 : 51.428302, -0.267347 Point 6 : 51.429822, -0.266934

John subscribes to the injection sources (see Table 17) which will help him in the travel's organization. He also called Trailfinder travel agency to book the plane tickets and rent a car for him. He calls the Regina Hotel to book a room for the length of the trip. He calls his doctor to organize the thermal session for him. Finally, John' daughter Patrice suggested injecting a family call situation in his application.

**Table 17: John's external injectors**

<b>Injector's Name</b>	<b>Category</b>	<b>Importance</b>
Trailfinder Travel agency	External/Business	P(2)
London Heathrow Airport	External/Government	P(1)
Biarritz Airport	External/ Government	P(1)
Regina Hotel	External/Business	P(2)
Bayonne Office of tourism	External/ Government	P(1)
Doctor Michal Prager	External/Business	P(3)
Kingston University	External/ Government	P(2)
Patrice	Social	P(1)

Since John wants to use LLA also for personal needs, he injected his daily situations and selected the services that he wishes to use for those situations. In figures 73, 74, and 75, we present the graphical representations of the situations injected by John.

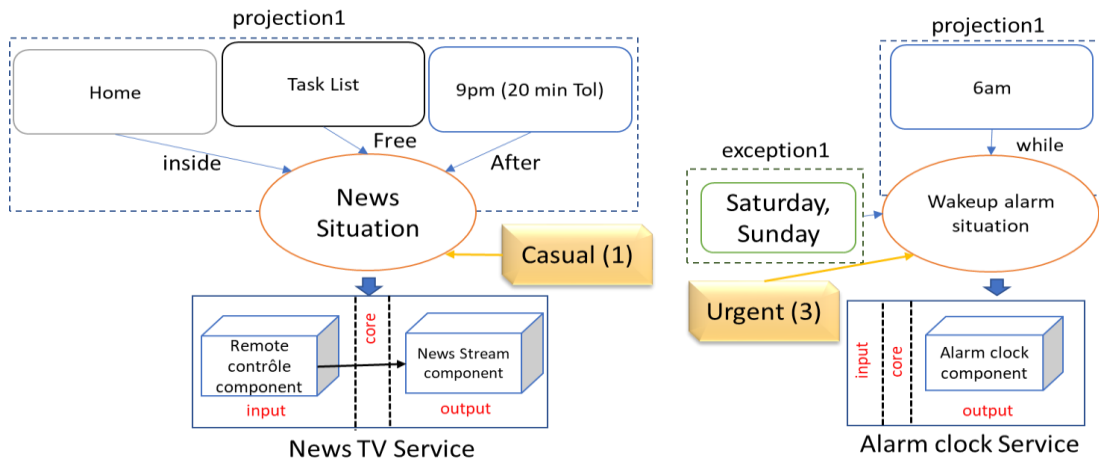

Figure 73 – News Situation and Wakeup Alarm Situation graphical representations

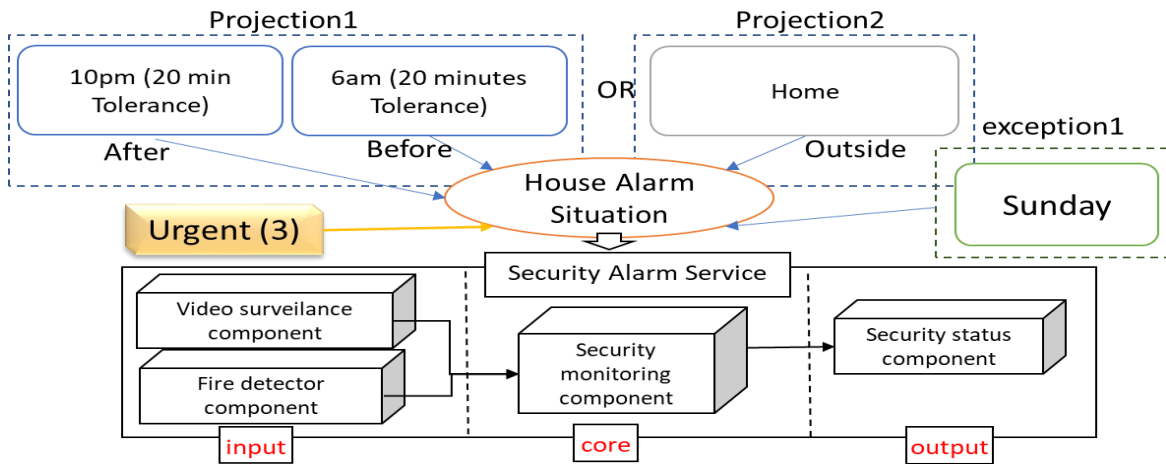

Figure 74 - House Alarm Situation graphical representation

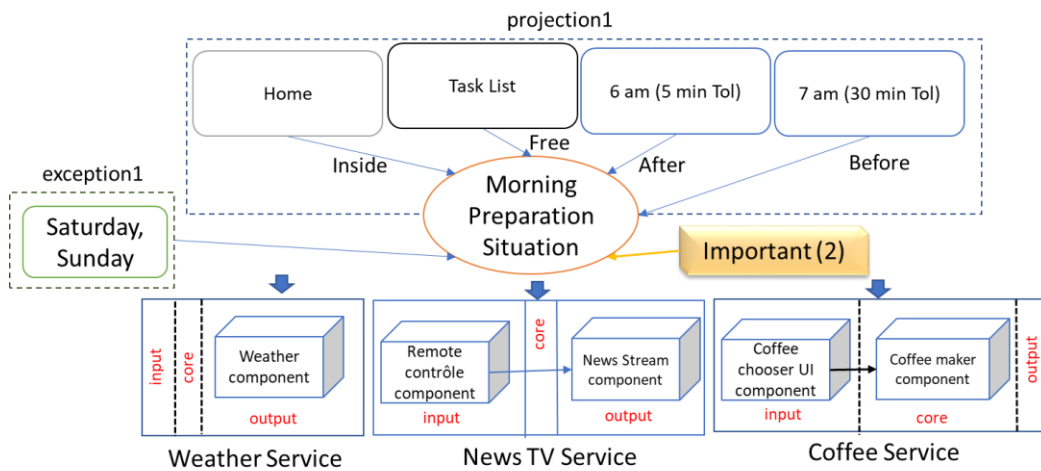

Figure 75 – Morning Preparation Situation graphical representation

The next step is defining the Lock Zones. Since he is traveling, John defines his zones (see Table 18) according to his availability on that day. These zones could be changed later when John comes back from the travel.

**Table 18: John's defined lock zones**

<b>Zone</b>	<b>Time</b>	<b>Location</b>	<b>Injection Source Priorities</b>	<b>Special Situation Priorities</b>
Morning Busy Zone	7 am - 10 am	--	Trailfinder Travel agency: P(3) London Heathrow Airport: P(2) John: P(2) Kingston University: P(1)	--
Flight Dead Zone	10 pm - 12 pm	--	John: P(3)	--
Evening Busy Zone	12 pm - 4 pm	--	Trailfinder Travel agency: P(3) Biarritz Airport: P(2) Regina Hotel: P(3)	--
Relaxation Dead Zone	6 pm - 8 pm	Center: 51.637818, -0.063590 Radius: 3600 m	John: P(1) Kingston University: P(1) Facebook: P(1)	--

Initially, John possesses a list of devices that he added into LLA. But we consider the public devices that he used along the journey. All the devices are described in Table 19. Since these devices are hard to acquire, some of them will be simulated in this experiment.

Table 19: John's user-domain

Device	Private/ Public	Capability	Model	Power	Unit	Returned data type	Status	Availability
Samsung Gear S3	Private	See Table 13.						
iMac [6]	Private	Network	Wifi 802.11ac	--	--	--	--	--
		Network	Ethernet	--	--	--	--	--
		Processor	Intel Core i5	3,6	G Hz	--	90 %	Free
		RAM	DDR4	32	G B	Memory usage	--	Free
		Storage	Fusion	1000	G B	Storage capacity	820	Free
		Camera	4K	8	M P	Photo/Vi deo	--	Free
		Display	Retina	21,5	inc hes	--	--	Free
		Keyboard	Magic	--	--	Text	--	Free
		Mouse	Magic 2	--	--	--	--	Free
		Graphic	Raedon	4	G B	--	--	Free
		Audio	Pro 7.1Ch 400W	104	dB	Sound	--	Free
Nest 2 <sup>nd</sup> G [77]	Private	SmokSensor	--	--	--	--	--	--
		Heat-sensor	--	--	--	--	--	--
		Humidity-sensor	--	--	--	--	--	--
		Presence-sensor	--	--	--	--	--	--
		Light-sensor	--	--	--	--	--	--
		Network	Wi-Fi	--	--	--	--	--
		Network	Bluetooth	--	--	--	--	--
Sony KDL-43W805 C Smart-TV [93]	Public (Hotel)	Display	X-Reality	43	inc hes	--	--	Free
		Network	Wi-Fi,	--	--	--	--	--
		Network	Infrared	--	--	--	--	--
		Network	Bluetooth	--	--	--	--	--
Audio	--	40	dB	Sound	--	Free		
Model S Tesla [98]	Private	Display	LCD	17	inc hes	--	--	Free
		GPS-sensor	--	--	--	--	--	Free



		Processor	AMD	--	--	--	--	Free
		Network	Cellular	--	--	--	--	--
		Network	Bluetooth	--	--	--	--	--
		Sound	--	--	dB	--	--	--
Samsung Galaxy S4 [46] (Preferred device)		Microphone	--	--	--	Sound	--	Free
		Camera	Back, Front	12, 2	MP	Photo/Video	--	Free
		GPS	--	--	--	Coordinates.	--	Free
		Battery	Li-Ion	2600	mAh	Charging Level	80%	Free
		Processor	Octa-core (Cortex-A15 ,Cortex-A7)	1.2&1.6	GHz	Processing power	90%	Free
		RAM	--	2	GB	Memory usage	1,2	Free
		Storage	--	16	GB	Storage capacity	3.2	Free
		Network	Wi-Fi	--	--	--	--	--
		Network	Infrared	--	--	--	--	--
		Network	Bluetooth	--	--	--	--	--
		Network	NFC	--	--	--	--	--
		Network	Cellular	--	--	--	--	--
		Display	Super AMOLED	5	inches	--	--	Free
		Audio	--	30	dB	Sound	--	Free
Mr. Coffee Smart [73]	Private	Network	Wifi 802.11ac	--	--	--	--	--
		Coffee-engine	--	--	--	--	--	--
Nest Cam IQ [78]	Private	Network	Wi-Fi	--	--	--	--	--
		Network	Bluetooth	--	--	--	--	--
		Camera	--	8	MP	Photo/Video	--	Free
Microsoft surface pro 4 [70]	Private	Microphone	--	--	--	Sound	--	Free
		Camera	Front	5	MP	Photo/Video	--	Free
		GPS	--	--	--	Coordinates.	--	Free
		Battery	--	--	mAh	Charging Level	--	--
		Processor	Intel Core i5	2.6	GHz	--	--	Free
		RAM	--	4	GB	Memory usage	--	Free
		Storage	--	512	GB	Storage capacity	--	Free
		Network	Wi-Fi	--	--	--	--	--
		Light-sensor	--	--	--	--	--	--
		Network	Bluetooth	--	--	--	--	--

		Camera	Back	8	MP	Photo/Video	--	--
		Network	Cellular	--	--	--	--	--
		Display	PixelSense	12.3	inches	--	--	Free
		Audio	--	30	dB	Sound	--	Free
		GPS-sensor	--	--	--	--	--	Free
		Vibration	--	--	--	--	--	Free
Audi A3 2016 [7]	Public (Hertz)	Display	LCD	12	inches	--	--	Free
		GPS-sensor	--	--	--	--	--	Free
		Network	Wifi	--	--	--	--	--
		Network	Cellular	--	--	--	--	--
Interactive Display Screen [87]	Public airport	Display	LCD	50	inches	--	--	Free
		Network	Wi-Fi	--	--	--	--	--
		Network	Bluetooth	--	--	--	--	--

### 2.2.2. LLA injects the necessary data

After finishing setting up LLA, and preparing the trip, the injection process starts in order to fill John’s persistence layer and allow the core modules (ECA) to start functioning. The injector inserts the situations, mappings, conditions, services description, and services.

In order for external providers to inject data into the user’s persistence layer, they need the approval of the user and his subscription. In order to define the situations easily, we propose a web (see Figure 76) application enabling to define situations, mappings, descriptions, and upload the services as Jars.

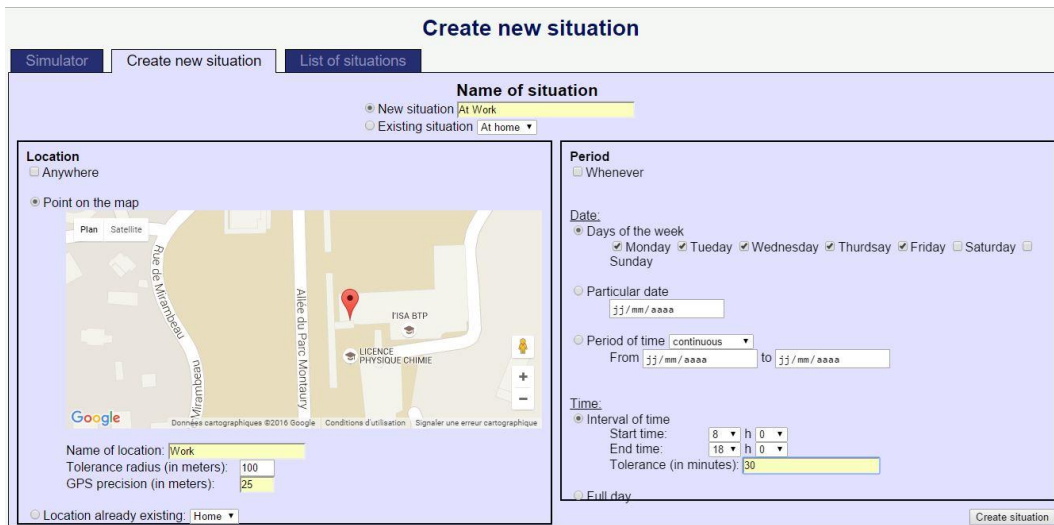

Figure 76 – LLA web application for injecting situations from external sources

- **Injected Situations:** They are injected using LLA’s injection UI and web app.

```

** Morning Preparation situation (S1): [priority=P(2); source="User/John"]; Projection1 [
Time(After(6,5), Before(7,30)); Location(Inside(Home, 0)); Activity(Free(TaskList))] EXCEPT [ (
Time(While(Sunday,0)) ; Time(While(Saturday,0))] ]
** News Situation (S2): [priority=P(1); source="User/John"]; Projection1 [
Time(After(21,15)); Location(Inside(Home, 0)); Activity(Free(TaskList))]
** Wakeup Alarm Situation (S3): [priority=P(3); source="User/John"]; Projection1[
Time(While(6,0))] EXCEPT [ ( Time(While(Sunday,0)) ; Time(While(Saturday,0)) ]
** Drive to the airport situation (S4): [priority=P(2); source="External/Business/
TrailfinderTravel Agency"]; Projection1 [Time( After(22/11/2016-7:0:0,20) Before(22/11/2016-
8:0:0,20)); Time*Location(Closer(Heathrow Airport, 22/11/2016-7:0:0, 22/11/2016-
8:0:0,100,25))]
** Heathrow Airport Parking Situation (S5): [priority=P(2); source="External/Government/
Heathrow Airport"] Projection1 [Location (Inside (Heathrow airport parking, 10))]
** Heathrow Airport Navigation Situation (S6): [priority=P(2); source="External/
Government/Heathrow Airport"] ; Projection1 [ Location(Inside(Heathrow airport, 10))]
** Biarritz Airport Navigation Situation (S7): [priority=P(2); source="External/
Government/Biarritz Airport"] ; Projection1 [ Location(Inside(Heathrow airport, 10))]
** Boarding Situation (S8): [priority=P(3); source=" External/ Business//TrailfinderTravel
Agency"]; Projection1 [Time( After(22/11/2016-9:30:0,30) Before(22/11/2016-10:0:0,30));
Location(Inside(Heathrow airport, Terminal 1, 10))]
** Flight Situation (S9): [priority=P(3); source=" External/ Business//Trailfinder Travel
Agency"]; Projection1 [Time( After(22/11/2016-10:0:0,60) Before(22/11/2016-12:0:0,60));
** Landing Situation (S10): [priority=P(2); source=" External/ Business//Trailfinder Travel
Agency"]; Projection1 [Time( After(22/11/2016-12:0:0,30) Before(22/11/2016-13:0:0,30));
Location(Inside(Biarritz Airport, 60))]
** Urgent Department Meeting Situation (S11): [priority=P(3);
source="External/Government/KingstonUniversity"]; Projection1 [ Time(After(22/11/2016-
13:0:0,5), Before(22/11/2016-13:30:0,5)); Activity(PlannedTask("Dpt meeting",TaskList))]
** Check-in Situation (S12): [priority=P(3); source="External/Business/ReginaHotel"] ;
Projection1[ Time(While(22/11/2016,0)); Location (Inside(Regina Hotel Biarritz, 60))]
** Room Unlocking situation (S13): [priority=P(3); source="External/Heathrow Airport"] ;
Projection1 [Time( After(22/11/2016-12:0:0,30) Before(27/11/2016-12:0:0,30));
Location(Inside(Regina Hotel, Floor 3, Room 51, 5))]
** Thermal Sessions situation (S14): [priority=P(3); source="External/Business/
DoctorPaiger"] ; Session1 [Time( After(22/11/2016-18:0:0,20) Before(22/11/2016-20:0:0,20));
Location(Inside(Cambo-les-bain, SpaResort, 20))] OR Session2 [Time( After(24/11/2016-
18:0:0,20) Before(24/11/2016-20:0:0,20)); Location(Inside(Cambo-les-bain, SpaResort,, 20))] OR
Session3 [Time (After(26/11/2016-18:0:0,20) Before(26/11/2016-20:0:0,20));
Location(Inside(Cambo-les-bain, SpaResort,, 20))]
** Medication Reminder Situation (S15): [priority=P(3); source="External/Business/
DoctorPaiger"] Projection1[ Time(While(21,30)); Activity(Free(TaskList))]
** Free Basque Museum Visit Situation (S16): [priority=P(1);
source="External/Government/ BayonneOfficeOfTourism"]; Projection1 [Time(
After(22/11/2016) Before(27/11/2016)); Location(Inside(Basque Museum, 10)); ]
** BAB Local Event Situation (S17): [priority=P(1); source="External/Government/
BayonneOfficeOfTourism"]; Projection1 [ Location(Inside(Basque Country, 1000));]
** Family Call Situation (S18): [priority=P(2); source="Social/Patrice"]; Projection1 [Time(
While(22/11/2016-21:0:0,10));]

```

- **Defined Conditions:** These conditions are the lock zones defined using LLA.

```

** Work Busy Zone (Z0): [Time( After(7,0) Before(10,0))]; [ISP [(Trailfinder Travel agency,3);
(London Heathrow Airport,2); (John,2); (Kingston University,1)]; SSP[]]
** Flight Dead Zone (Z1): [Time( After(10,0) Before(12,0))]; [ISP [ (John,2)]; SSP[]]
** Evening Busy Zone (Z2): [Time( After(12,0) Before(16,0))]; [ISP (Trailfinder Travel
agency,3);(Biarritz Airport,2);(Regina Hotel,3)]; SSP[]]
** Relaxation Dead Zone (Z3): [Time( After(18,0) Before(20,0); Location(Inside(Cambo-Les-
Bains, SpaZone, 0))]; [ISP [(John,1);(Kingston University,1);(Facebook,1)]; SSP[]]

```

- **Injected Mappings:** The mappings are also injected along the situations to link them to services.

```

** M0: House Alarm Situation [Projection1 [Security Alarm Service]]
** M1: Wake Alarm Situation [Projection1 [Alarm Clock Service]]
** M2: Morning Preparation Situation [Projection1 [Weather Service, News Tv Service,
Coffee Service]]
** M3: News Situation [Projection1 [News Tv Service]]
** M4: Drive to airport situation [Projection1 [Road Service]]
** M5: Heathrow Airport Parking Situation [Projection1 [Parking Service]]
** M6: Heathrow Airport Navigation Situation [Projection1 [Airport Navigation Service]]
** M7: Biarritz Airport Navigation Situation [Projection1 [Airport Navigation Service]]
** M8: Boarding Situation [Projection1 [Boarding Pass Service]]
** M9: Flight Situation [Projection1 [Music Service]]
** M10: Landing Situation [Projection1 [Car Rental Service]]
** M11: Urgent Department Meeting Situation [Projection1 [Skype Service]]
** M12: Check-in Situation [Projection1 [Check-in Service]]
** M13: Room Unlocking Situation [Projection1 [Door Lock Service]]
** M14: Thermal Session Situation [Session1 [Health Monitor Service]; Session2 [Skype
Service]; Session3 [BioMetric Measuring Service]]
** M15: Medication Reminder Situation [Projection1 [Reminder Service]]
** M16: Free Basque Museum Visit Situation [Projection1 [Entry Ticket Service; Museum
Guide Service]]
** M17: BAB Local Event Situation [Projection1 [Event Recommender Service]]
** M18: Family Call Situation [Projection1 [Skype Service]]

```

- **Injected Services descriptions:** The services composition and requirements are defined by the developer of those services using the web app.

```

**News Tv Service: [Input [Remote Control component ((S!Display>=5inch)&
(S!Network="Infrared"|"Bluetooth"|"Wifi"))]; Output [News Stream component
(S!Display>28inches)] | Links [Remote Control component -> News Stream component]
**Road Service: [Input [Tracker Component (!GPS-sensor)]; Output [Map component
(S!Display>7inches)] | Links [Tracker Component -> Map component]
**Car Rental Service: [Input [Tracker Component (!GPS-sensor)]; Output [Rental
component (S!Display>=5inches)] | Links [Tracker Component -> Rental component]
**Airport Navigation Service: [Input [Tracker Component (!GPS-sensor)]; Output
[Airport Map component (S!Display>7inches)] | Links [Tracker Component -> Airport Map
component]
**Museum Guide Service: [Input [Tracker Component (!GPS-sensor)]; Output [Museum
Map component (S!Display>7inches)] | Links [Tracker Component -> Airport Map
component]

```

**\*\*Parking Service:** [Input [Tracker Component (!GPS-sensor)]; Output [Parking Payment component ((S!Display>7inches)&(S!Network="Wifi)) | Links [Tracker Component -> Parking Payment component]

**\*\*Event Recommender Service:** [Input [Tracker Component (!GPS-sensor)]; Output [Near By Events component ((S!Display>7inches)&(S!Network="Wifi)) | Links [Tracker Component -> Near By Events component]

**\*\*Door Lock Service:** [Core [Locker Component (S!Network="NFC")]; Output [Lock UI component (S!Display>7inches) | Links [Tracker Component -> Lock UI component]

**\*\*Health Monitor Service:** [Input [Health data collector component (!!Heart rate sensor)& (!Accelerometer)&(!Gyroscope)]; Core [Health data analyzer component (D!RAM>1GB)]; Output [Results component (S!Display>5inch) | Links (Health data collector component -> Health data analyzer component; Health data analyzer component -> Results component;)]

**\*\*BioMetric Measuring Service:** [Input [Heat component (!Heat-sensor)]; Core [Health data analyzer component (S!RAM>2GB)]; Output [Results Sender (S!Display>5inch) | Links (Heat component -> Health data analyzer component; Health data analyzer component -> Results Sender component;)]

**\*\*Reminder Service:** [Output [Reminder component (!Display)]]

**\*\*Reminder Service:** [Output [Music component (!!Sound)&(!Display)]]

**\*\*Weather Service:** [Output [Weather component (!Display)]]

**\*\*Boarding Service:** [Output [Boarding Pass component (!Display)]]

**\*\*Landing Service:** [Output [Rental Contract component (!Display)]]

**\*\*Check-in Service:** [Output [Check-in Signature component (!Display)]]

**\*\*Entry Ticket Service:** [Output [Ticket component (S!Display<5)]]

**\*\*Alarm Clock Service:** [Output [Alarm Clock Component (!!Display)& (S!Sound>20dB) &(!Vibration)]]

**\*\*Skype Service:** [(Input [Picture feed component (!Camera); Sound feed component (!Microphone); Text feed component (!!Keyboard)!!(Display)]; Core [Skype core component (D!RAM>2.5GB)]; Output [Image output component (S!Display>16inch); Text UI component (S!Display>10inch); Sound output component (S!Audio<40dB) | Links (Picture feed component -> Skype core component; Sound feed component -> Skype core component; Text feed component -> Skype core component; Skype core component -> Image output component; Skype core component -> Sound output component; Skype core component -> Text UI component;)]

**\*\*Security Alarm Service:** [Input [Video Surveillance component (!!Camera)& (S!Network="Wifi); Fire detector component(!Smoke-sensor)]; Core [Security monitoring component (D!RAM>1GB)]; Output [Security status component (S!Display<5inches) | Links (Video Surveillance component -> Security monitoring component; Fire detector component -> Security monitoring component; Security monitoring component -> Security status component;)]

**\*\*Coffee Service:** [Input [Coffee Chooser UI Component (S!Display=5inches)]; Core [Coffee Maker component (!Coffee-engine) | Links [Coffee Chooser UI Component -> Coffee Maker component]

### 2.2.3. John starts the journey

LLA evolves following John’s movements. As the scenario involves different locations, times, and activities, we chose to simulate them in order to facilitate the testing process. For locations, we use a mock location application called Mock Locations [42]. For activities, we use a dedicated Google Calendar where we inserted the required activities. Some of the figures in this section are created only to show the potential of LLA but were not really tested on those devices (car, interactive panel, and smart-watch) due to lack of resources.

In order to respond to his needs, LLA needs to be aware of his context at all times. We provide for each step (see Figure 71) of the travel the inputs and outputs of the main modules and we show, using some screenshots, how LLA deploys and integrates services into its UI so John can be able to use them. John starts the day with all his available devices (User-Domain) (see Table 19) except for his car which is turned off in the garage.

- **Step 1:** John woke up and started the morning (see Figure 77).

Table 20: LLA's core modules on step 1

Input Component	Event Manager	Condition Evaluation	Action Orchestration
Time: 06:00 Location: Home Activity: Free	Starting Situations: S1, S2, S3 Ending Situations: -- Active Situations: --	Lock Zone: Free Zone Sorted Starting Situations: S3, S1, S2 Ending Situations: --	Starting Commands 1

➔Starting Commands 1 (deploying Alarm Clock Service, Weather Service, News Tv Service, and Coffee Service):

```

SamsungGalaxyS4 : CreateConnector UICM SamsungGalaxyS4 iMAC
SamsungGalaxyS4 : CreateConnector RCTV SamsungGalaxyS4 MrCoffeeSmart

MicrosoftSurfacePro: CreateComponent AlarmClock
application.User.Morning.output.AlarmClockBC [null] [null]

SamsungGalaxyS4: CreateComponent CoffeeChooserUI
application.User.Morning.Input.CoffeeUIBC [null] [UICM]

MrCoffeeSmart: CreateComponent CoffeeMaker
application.User.Morning.core.CoffeeMakerBC [UICM] [null]

iMAC: CreateComponent AccuWeather application.Accu.output.AccuWeatherBC
[null] [null]
    
```

```

SamsungGalaxyS4: CreateComponent RemoteControl
application.BBC.News.Input.RemoteControlBC [null] [RCTV]

iMAC: CreateComponent NewsStream application.BBC.News.Output.VideoPlayerBC
[RCTV] [null]
    
```

⇒ User-Domain: After John uses these services and is about to leave the house, he starts his car which is added to his domain and turned off his tablet and put it on his bag.



Figure 77 - Print screens of LLA's output for step 1

- **Step 2 and 3:** John leaves his house and heads to the airport (see Figure 78).

Table 21: LLA's main modules results for step 2 and 3

Input Component	Event Manager	Condition Evaluation	Action Orchestration
Time: 07:10 Location: Driving Activity: "To the airport"	Starting Situations: S0, S4 Ending Situations: S1, S2, S3 Active Situations: --	Lock Zone: Z0 Sorted Starting Situations: S0, S4 Ending Situations: S1, S2, S3	Starting Commands 2 Stopping Commands 1

➔ Starting Commands 2 (deploying House Alarm Service, Road Service):

```

ModelSTesla : CreateConnector DAS ModelSTesla ModelSTesla
Nest2G : CreateConnector FCSA Nest2G iMAC
NestCamIq : CreateConnector PDSA NestCamIq iMAC
iMAC : CreateConnector SASM iMAC SamsungGearS3
    
```

```

Nest2G: CreateComponent FireDetector
application.SafeCorp.input.FireDetectorBC [null] [FCSA]

Nest2G: CreateComponent VideoSurveillance
application.SafeCorp.input.SurveillanceBC [null] [PDSA]

iMAC: CreateComponent SecurityMonitor
application.SafeCorp.core.SecurityMonitorBC [FCSA PDSA] [SASM]

SamsungGearS3: CreateComponent SecurityStatus
application.SafeCorp.output.SecurityStatusBC [UICM] [null]
ModelSTesla: CreateComponent Tracker application.User.input.TrackerBC
[null] [DAS]
ModelSTesla: CreateComponent RoadMap application.User.input.MapBC [DAS]
[null]

```

➔ Stopping Commands 1 (stopping Alarm Clock Service, Weather Service, News Tv Service, and Coffee Service):

```

SamsungGalaxyS4 : RemoveConnector UICM
SamsungGalaxyS4 : RemoveConnector RCTV
SamsungGalaxyS4: RemoveComponent RemoteControl
iMAC: RemoveComponent NewsStream
SamsungGalaxyS4: RemoveComponent CoffeeChooserUI
MrCoffeeSmart: RemoveComponent CoffeeMaker
MicrosoftSurfacePro: RemoveComponent AlarmClock
iMAC: RemoveComponent AccuWeather

```

⇒ User-Domain: There has been no change in the user-domain after these deployments.



Figure 78 - Print screens of LLA's output for step 2 and 3



- **Step 4:** John arrives at the airport’s parking

**Table 22: LLA's core modules on step 4**

Input Component	Event Manager	Condition Evaluation	Action Orchestration
Time: 07:55 Location: Heathrow Airport Parking Activity: Free	Starting Situations: S5, S6 Ending Situations: S4 Active Situations: S0	Lock Zone: Z0 Sorted Starting Situations: S5, S6 Ending Situations: S4	Starting Commands 3 Stopping Commands 2

➔ Starting Commands 3 (deploying Parking Service, Airport Navigation Service):

```

ModelSTesla : CreateConnector PS ModelSTesla ModelSTesla
SamsungGearS3 : CreateConnector ANS SamsungGearS3 SamsungGalaxyS4
ModelSTesla: CreateComponent Tracker application.User.input.TrackerBC
[null] [PS]
ModelSTesla: CreateComponent ParkingPaeyment
application.HethrowAirport.output.PaymentUIBC [PS] [null]
SamsungGearS3: CreateComponent Tracker application.User.input.TrackerBC
[null] [ANS]
SamsungGalaxyS4: CreateComponent HeathrowNavigation
application.HethrowAirport.output.NavigationBC [ANS] [null]
    
```

➔ Stopping Commands 2 (stopping Road Service):

```

ModelSTesla : RemoveConnector DAS
ModelSTesla: RemoveComponent Tracker
ModelSTesla: RemoveComponent RoadMap
    
```

⇒ User-Domain: John left the parking and stopped his car and therefore it is removed from his domain. When he enters the airport, he added the interactive panel public device available in the airport.

- **Step 5:** John is about to board the plane (see Figure 79)

**Table 23: LLA's core modules on step 5**

Input Component	Event Manager	Condition Evaluation	Action Orchestration
Time: 09:35 Location: Heathrow Airport Terminal 1 Activity: Free	Starting Situations: S8 Ending Situations: S5 Active Situations: S0, S6	Lock Zone: Z0 Sorted Starting Situations: S8 Ending Situations: --	Starting Commands 4 Stopping Commands 3

→ Starting Commands 4 (deploying Boarding Service):

```
SamsungGalaxyS4: CreateComponent BoardingPass
application.Airfrance.output.BoardingPassBC [null] [null]
```

→ Stopping Commands 3 (stopping Parking Service):

```
ModelSTesla : RemoveConnector PS
ModelSTesla: RemoveComponent Tracker
ModelSTesla: RemoveComponent ParkingPaeyment
```

⇒ User-Domain: After John gets in the plane migrates the security component to his iMac manually and puts all his devices that he is carrying with him (Samsung Galaxy S4, Samsung Gear 3, and Microsoft Surface Pro) on airplane mode. LLA continues to run on the available devices at his home.

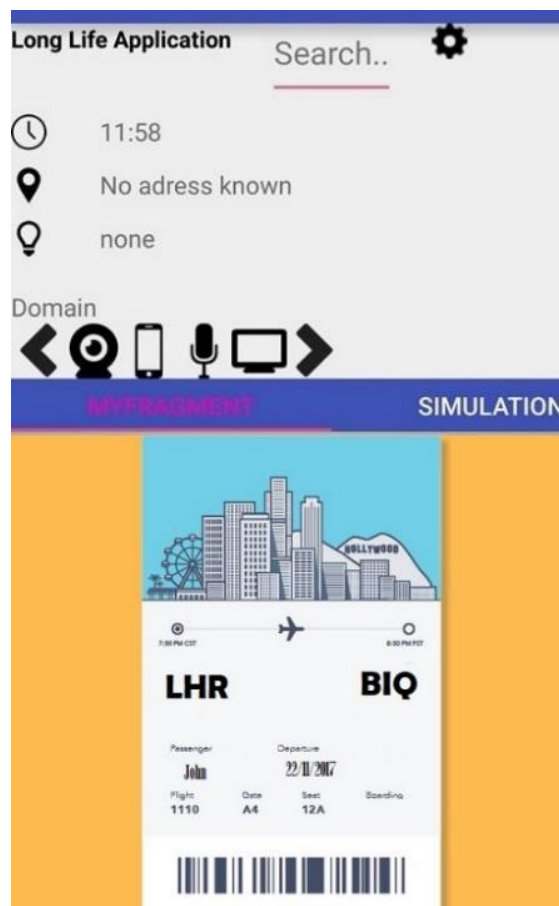

Figure 79 - Print screens of LLA's output for step 5

- **Step 6:** John is on the plane (see Figure 80).

**Table 24: LLA's main modules results for step 6**

Input Component	Event Manager	Condition Evaluation	Action Orchestration
Time: 10:05 Location: Unknown Activity: Flight to Biarritz	Starting Situations: S9 Ending Situations: S8, S6 Active Situations: S0	Lock Zone: Z1 Sorted Starting Situations: S9 Ending Situations: S8, S6	Starting Commands 5 Stopping Commands 4 Migration Commands 1

➔ Migration Commands 1 (migrating House Alarm Security; done manually by John):

```
SamsungGearS3 : SendComponent SecurityStatus iMac
```

➔ Starting Commands 5 (deploying Music Service):

```
SamsungGalaxyS4: CreateComponent MusicPlayer  
application.Deezer.output.MusicPlayerBC [null] [null]
```

➔ Stopping Commands 4 (stopping Airport Navigation Service):

```
SamsungGearS3 : RemoveConnector ANS  
ModelSTesla: CreateComponent Tracker  
ModelSTesla: CreateComponent HeathrowNavigation
```

⇒ User-Domain: After John gets in the plane he puts all his devices that he is carrying with him (Samsung Galaxy S4, Samsung Gear 3, and Microsoft Surface Pro) on airplane mode. LLA continues to run on the available devices at his home.



**Figure 80 - Print screens of LLA's output for step 6**

- **Step 7:** John lands in Biarritz.

Table 25: LLA's main modules results for step 7

Input Component	Event Manager	Condition Evaluation	Action Orchestration
Time: 12:15 Location: Biarritz Airport Activity: Free	Starting Situations: S7, S10 Ending Situations: S9 Active Situations: S0	Lock Zone: Z2 Sorted Starting Situations: S7, S10 Ending Situations: S9	Starting Commands 6 Stopping Commands 5

➔ Starting Commands 6 (deploying Car Rental Service and Biarritz Navigation Service):

```
SamsungGearS3 : CreateConnector RCC SamsungGearS3 SamsungGalaxyS4
SamsungGearS3 : CreateConnector BAC SamsungGearS3 SamsungGalaxyS4
SamsungGearS3: CreateComponent Tracker application.User.input.TrackerBC
[null] [RCC BAC]
SamsungGalaxyS4: CreateComponent RentalContract
application.Hertz.output.ContractBC [RCC] [null]
SamsungGalaxyS4: CreateComponent BiarritzNavigation
application.BIQAirport.output.NavigationBC [BAC] [null]
```

➔ Stopping Commands 5 (stopping Music Service):

```
SamsungGalaxyS4: RemoveComponent MusicPlayer
```

⇒ User-Domain: John puts his devices back online and reconnects to the home devices running LLA. He adds the car that he rented (Audi A3) to his user-domain.

- **Step 8:** John is in the hotel parking and stops to take his meeting call (see Figure 81).

Table 26: LLA's main modules results for step 8

Input Component	Event Manager	Condition Evaluation	Action Orchestration
Time: 13:05 Location: Regina Hotel Parking Activity: Urgent Meeting	Starting Situations: S11 Ending Situations: S7, S10 Active Situations: S0	Lock Zone: Z2 Sorted Starting Situations: S11 Ending Situations: S7	Starting Commands 7 Stopping Commands 6

➔ Starting Commands 7 (deploying Skype Service):

```

SamsungGalaxyS4 : CreateConnector TFC SamsungGalaxyS4 AudiA3
SamsungGalaxyS4 : CreateConnector PFC SamsungGalaxyS4 AudiA3
SamsungGalaxyS4 : CreateConnector VFC SamsungGalaxyS4 AudiA3
AudiA3 : CreateConnector SOSC AudiA3 AudiA3
AudiA3 : CreateConnector UIOSC AudiA3 AudiA3

SamsungGalaxyS4: CreateComponent TextFeed
application.Skype.input.KeyboardBC [null] [TFC]
SamsungGalaxyS4: CreateComponent VoiceFeed
application.Skype.input.KeyboardBC [null] [VFC]
SamsungGalaxyS4: CreateComponent PictureFeed
application.Skype.input.KeyboardBC [null] [PFC]

AudiA3: CreateComponent SkypeCore application.Skype.core.SkypeBC [TFC VFC
PFC] [SOSC UIOSC]
AudiA3: CreateComponent ChatSound application.Skype.output.SoundBC [SOSC]
[null]
AudiA3: CreateComponent SkypeUI application.Skype.output.SkypeUIBC [UIOSC]
[null]

```

➔ Stopping Commands 6 (stopping Car Rental Service):

```

SamsungGearS3 : RemoveConnector RCC
SamsungGearS3 : RemoveConnector BAC
SamsungGearS3: RemoveComponent Tracker
SamsungGalaxyS4: RemoveComponent RentalContract
SamsungGalaxyS4: RemoveComponent RentalContract

```

⇒ User-Domain: While the Skype Service is running, the SamsungGalaxyS4 phone host components that take the camera and microphone which changes these capabilities' availability to Taken.

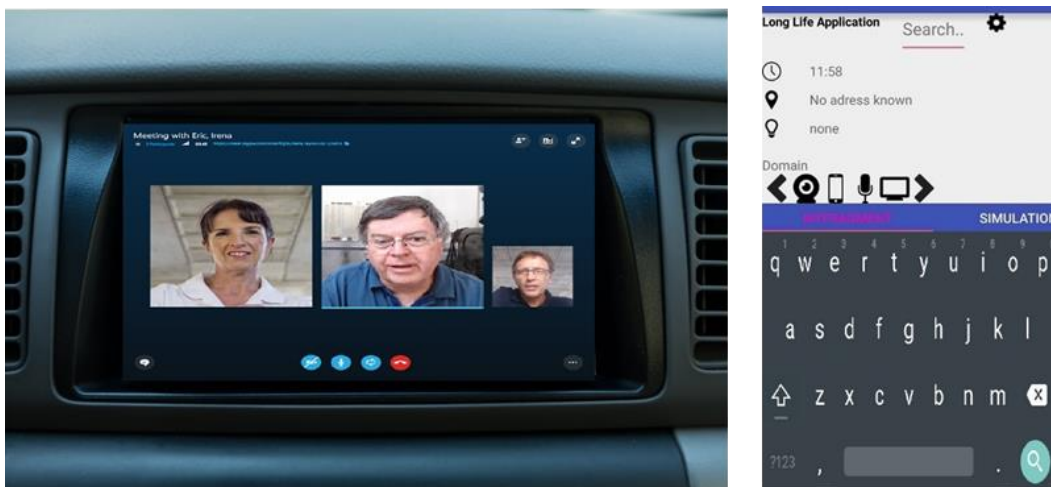

Figure 81 - Print screens of LLA's output for step 7

- **Step 9:** John does the check-in

**Table 27: LLA's main modules results for step 9**

<b>Input Component</b>	<b>Event Manager</b>	<b>Condition Evaluation</b>	<b>Action Orchestration</b>
Time: 14:00 Location: Regina Hotel Reception Activity: Check-In	Starting Situations: S12 Ending Situations: S11 Active Situations: S0	Lock Zone: Z2 Sorted Starting Situations: S12 Ending Situations: S11	Starting Commands 8 Stopping Commands7

➔ Starting Commands 8 (deploying Check-in Service):

*MicrosoftSurfacePro: CreateComponent Check-in application.Regina.output.CheckInBC [null] [null]*

➔ Stopping Commands 7 (stopping Skype Service):

*SamsungGalaxyS4 : RemoveConnector TFC  
 SamsungGalaxyS4 : RemoveConnector PFC  
 SamsungGalaxyS4 : RemoveConnector VFC  
 AudiA3 : RemoveConnector SOSC  
 AudiA3 : RemoveConnector UIOSC  
 SamsungGalaxyS4: RemoveComponent TextFeed  
 SamsungGalaxyS4: RemoveComponent VoiceFeed  
 SamsungGalaxyS4: RemoveComponent PictureFeed  
 AudiA3: RemoveComponent SkypeCore  
 AudiA3: RemoveComponent ChatSound  
 AudiA3: RemoveComponent SkypeUI*

⇒ User-Domain: No changes happened to the user-domain.

- **Step 10:** John goes to the office of tourism of Bayonne

**Table 28: LLA's main modules results for step 10**

<b>Input Component</b>	<b>Event Manager</b>	<b>Condition Evaluation</b>	<b>Action Orchestration</b>
Time: 15:20 Location: Office Tourism Bayonne Activity: Free	Starting Situations: -- Ending Situations: S12 Active Situations: S0	Lock Zone: Z2 Sorted Starting Situations: - - Ending Situations: S12	Stopping Commands8

➔ Stopping Commands 8 (stopping Check-in Service):

*MicrosoftSurfacePro: RemoveComponent Check-in*

⇒ User-Domain: No changes happened to the user-domain.

- **Step 11:** John arrives at the museum.

**Table 29 : LLA's main modules results for step 11**

Input Component	Event Manager	Condition Evaluation	Action Orchestration
Time: 15:40 Location: Basque Country Museum Activity: Free	Starting Situations: S16 Ending Situations: -- Active Situations: S0	Lock Zone: Z2 Sorted Starting Situations: S16 Ending Situations: --	Starting Commands 9

➔ Starting Commands 9 (deploying Entry Ticket Service and Museum Guide Service):

```
SamsungGearS3 : CreateConnector MTC SamsungGearS3 SamsungGalaxyS4
SamsungGearS3: CreateComponent Tracker application.User.input.TrackerBC [null] [MTC]
SamsungGalaxyS4: CreateComponent MuseumMap application.BasqueMeuseum.output.MuseumMapBC [RCC] [null]
SamsungGear3: CreateComponent MeuseumTicket application.BABEvents.output.TicketBC [null] [null]
```

⇒ User-Domain: No changes happened to the user-domain.

- **Step 12:** John is doing his heat treatment session in the resort (see Figure 82).

**Table 30 : LLA's main modules results for step 12**

Input Component	Event Manager	Condition Evaluation	Action Orchestration
Time: 18:02 Location: Cambo-Spa Resorts Activity: Heat-treatment session	Starting Situations: S14 Ending Situations: S16 Active Situations: S0	Lock Zone: Z3 Sorted Starting Situations: S14 Ending Situations: S16	Starting Commands 10 Stopping Commands 9

➔ Starting Commands 10 (deploying Health Monitor Service):

```
SamsungGearS3 : CreateConnector DCC SamsungGearS3 iMAC
SamsungGearS3 : CreateConnector RCC iMAC SamsungGearS3
SamsungGearS3: CreateComponent DataCollector application.DePaige.input.HealthDataCollectorBC [null] [DCC]
```

```
iMAC: CreateComponent DataAnalyzer
application.DePaige.core.HealthDataAnalyzerBC [null] [DCC]

SamsungGearS3: CreateComponent HealthResults
application.DePaige.output.HealthStatusBC [RCC] [null]
```

➔ Stopping Commands 9 (stopping Free Ticket Service and Museum Guide Service):

```
SamsungGearS3 : RemoveConnector MTC
SamsungGearS3: RemoveComponent Tracker
SamsungGalaxyS4: RemoveComponent MuseumMap
SamsungGear3: RemoveComponent MeuseumTicket
```

⇒ User-Domain: When John leaves he turns back on his devices

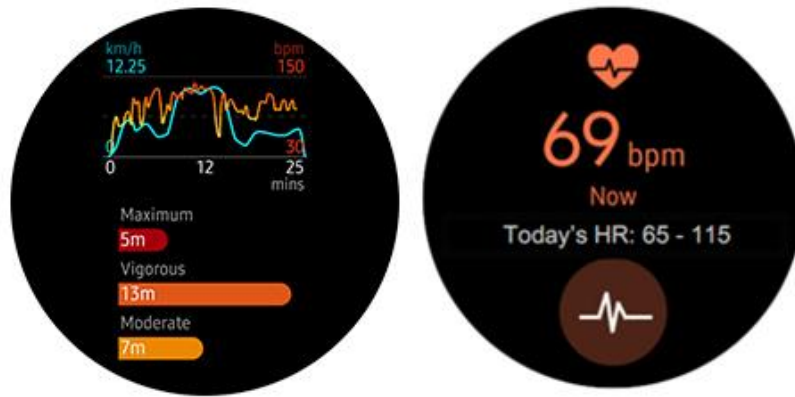

Figure 82 - Print screens of LLA's output for step 12

- **Step 13, 14, and 15:** John finally heads back to his hotel room.

Table 31: LLA's main modules results for step 13, 14, and 15

Input Component	Event Manager	Condition Evaluation	Action Orchestration
Time: 21:22 Location: Regina Hotel, Floor 3, Room 51 Activity: Free	Starting Situations: S13, S15, S18 Ending Situations: S14 Active Situations: S0	Lock Zone: Free Sorted Starting Situations: S13, S15, S18 Ending Situations: S14	Starting Commands 11 Stopping Commands 10

➔ Starting Commands 11 (deploying Door Unlocking Service, Medicine Reminder, and Skype Service):



```

MicrosoftSurfacePro :CreateConnector TFC MicrosoftSurfacePro
MicrosoftSurfacePro
MicrosoftSurfacePro : CreateConnector PFC MicrosoftSurfacePro
MicrosoftSurfacePro
MicrosoftSurfacePro : CreateConnector VFC MicrosoftSurfacePro
MicrosoftSurfacePro
MicrosoftSurfacePro : CreateConnector SOSC MicrosoftSurfacePro Sony-KDL-
43W805
MicrosoftSurfacePro : CreateConnector UIOSC MicrosoftSurfacePro Sony-KDL-
43W805

SamsungGalaxyS4: CreateComponent DoorLock
application.ReginaHotel.output.LockBC [null] [null]

SamsungGearS3: CreateComponent MedecineReminder
application.DrPaiger.output.ReminderBC [null] [null]

MicrosoftSurfacePro: CreateComponent TextFeed
application.Skype.input.KeyboardBC [null] [TFC]
MicrosoftSurfacePro: CreateComponent VoiceFeed
application.Skype.input.KeyboardBC [null] [VFC]
MicrosoftSurfacePro: CreateComponent PictureFeed
application.Skype.input.KeyboardBC [null] [PFC]

Sony-KDL-43W805: CreateComponent SkypeCore application.Skype.core.SkypeBC
[TFC VFC PFC] [SOSC UIOSC]

Sony-KDL-43W805: CreateComponent ChatSound application.Skype.output.SoundBC
[SOSC] [null]
Sony-KDL-43W805: CreateComponent SkypeUI application.Skype.output.SkypeUIBC
[UIOSC] [null]

```

➔ Stopping Commands 10 (stopping Health Monitor Service):

```

SamsungGearS3 : RemoveConnector DCC
SamsungGearS3 : RemoveConnector RCC
SamsungGearS3: RemoveComponent DataCollector
iMAC: RemoveComponent DataAnalyzer
SamsungGearS3: RemoveComponent HealthResults

```

⇒ User-Domain: I the hotel room, John adds the Sony-Tv to his personal user-domain in order to use it with LLA.

To summarize, this scenario proves the feasibility and usability of our proposal with all its aspects (context-awareness, distribution, injection, etc.).

### 3. Results and validation

#### 3.1. Performance validation

The management of the scenario described in this Chapter involves many different mechanisms. Thus, we present in this section the results obtained after implementing the proposed architecture (see Chapter 3) and testing it on an Android device (Samsung Galaxy S4 running Android 5.0.1 on an ARMv7 processor and 2GB RAM).

For evaluation purposes, in the developed prototype we have included a generator that creates a specified number of situations. We injected the considered scenario described above into the situation generator, and we ran the application while simulating the location, time and activity of the user.

For this experiment, we set up a time-frequency for data extraction (Input Component, IC) of 20 seconds and a location frequency of 10 meters (i.e., the data extraction is triggered when the user moves 10 meters). On the user's device, all other apps (except the mock location app) were disabled, the GPS was activated, the Wi-Fi was activated, and the battery was plugged.

We simulated a scalability experiment for different numbers of situations, and we calculated and observed the following metrics: the average CPU usage when the app is launched and while it is running later, the average memory usage while the app is running, the response time values:

- **Start-Parse:** The time that took the app to launch/generate/parse
- **Extract-Detect:** The time that it took from the moment that the IC sent the detected data until the situation was detected.
- **Detect-React:** The time since the situation is detected until the services are physically launched on the user's devices.

We also present the accuracy of situation detection which represents the percentage of detecting the correct situation. The main performance results are shown in Table 32. Besides, we also verified that the situations were correctly detected.

**Table 32: Measurements of performance, accuracy, and sustainability**

Number	Average CPU		Average Memory Use	Response Time			Accuracy
	At launch	Run ning		Start - Parse	Extract - Detect	Detect - React	
10	20%	1.1%	23 MB	4s	0.2s	0.4s	100%
10 <sup>2</sup>	30%	1.2%	30.6 MB	10s	0.5s	0.4s	100%
10 <sup>3</sup>	40%	21%	56 MB	2m	25s	0.5s	100%

These results show that our proposal is stable overall (see Figures 83, 84, and 85). When the number of considered situations increases, a critical point is not reached until having a very large number of situations to detect (in our experiments, above 10<sup>4</sup>), which is highly-improbable for everyday usage.



**Figure 83: Overtime performance of LLA (10 situations)**

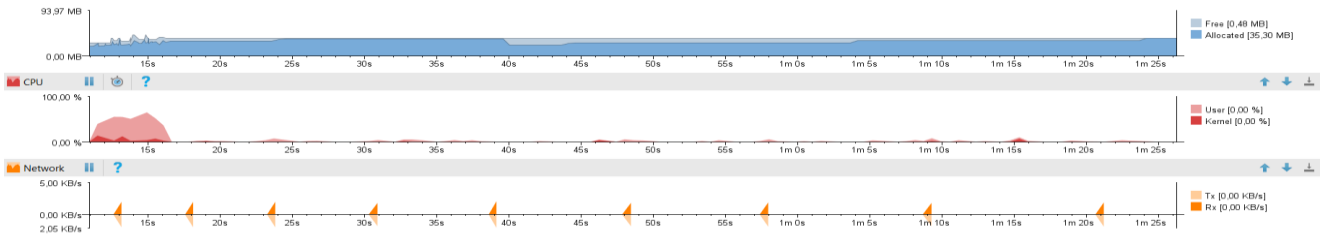

**Figure 84: Overtime performance of LLA (100 situations)**

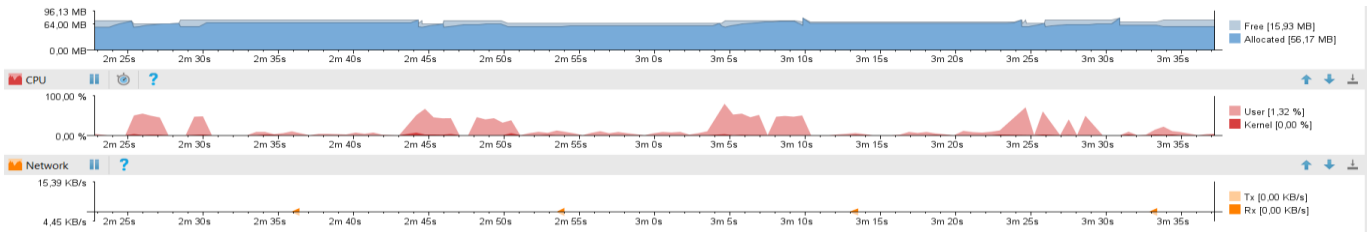

**Figure 85: Overtime performance of LLA (1000 situations)**

When reaching 10<sup>3</sup> situations, the application keeps running well but takes a larger time to start and demands more memory space and time to process data, which is logical considering

the complexity and possible combinations of situations. Nonetheless, even if this number is high (2 minutes) it is only done when starting the application for the first time or when there is a major change in the situations file.

Besides, this is not a final product, but a prototype and the performance is expected to increase when the architecture is deployed in a real user domain using more advanced devices (e.g., high-end smartphones or computers). The experiments that we have performed show the feasibility, scalability, and sustainability of our proposal.

### 3.2. Time and storage gain

Using LLA, users don't have to download applications on all the devices that they possess. This offers a considerable amount of data and memory gain compared to the classic approach of duplicating the application everywhere, which requires the updates to be done on all the devices.

In LLA, the component-based services require updates to be done separately and in a centralized way towards the user's cloud persistence layer. In order to calculate this gain, we consider the services used in John's scenario and we compared to using the current approach of downloading those services as stand-alone applications.

In order to measure this gain, we compare LLA to the classical approach (currently used mobile applications). This comparison is done by considering an estimate of the required storage size and the time required for the different operations (install/update/delete).

For LLA the real storage size on the device is the size of the basic application (ECA core components size = 10 MB) which is installed on John's 11 devices (see Table 19). Even though, the services that LLA uses come from the cloud persistence layer, we consider in this calculation that the user downloaded locally all the services in order to use them offline across his/her devices.

$$\text{Size of LLA} = (\text{Size of core components} * \text{Number of devices}) + \text{Size of services}.$$

For the classical approach, John has to download all the applications on all the devices. For this calculation, we consider applications related to the services. For example, a Map Service in LLA is equivalent to an application like Google Maps. We also consider an average size of the application since the sizes vary according to the device it is installed on. For example, Skype installed on Android require, on the estimate, 96.28 MB but 88.8 MB on a computer (Windows) so we consider the round average of 92MB.

$$\text{Size of Classical approach} = \text{Number of devices} * \text{Size of applications}$$

The operation time aspect represents the time taken by John to download, install LLA, configure it, update it, and deleting it. For the classical approach, it represents the time taken by John to download, install, update, and delete all the different applications on all the devices. For these calculations, we consider the Samsung Galaxy S4 device and an internet speed of 4.29 MB/s.

**Table 33: Comparison of LLA and classical mobile store approach**

	<b>LLA</b>	<b>Classical approach</b>
<b>Overall Size</b>	374 MB	2904 MB
<b>Total Download</b>	01:29	11: 40
<b>Installation Time</b>	00:23	01:33:30
<b>Total Delete Time</b>	00:02	00:22
<b>Total Update (Delete + Download + Installation) Time</b>	01:54	01:45:32

These results (see Table 33) demonstrate that using LLA offers a considerable amount of time and storage gain due to its dynamicity and the distributed nature of its services.

#### **4. Conclusion**

In this chapter, we demonstrated the feasibility of our proposal. Long Life Application is a concept that requires major changes in the way we consider mobile applications. Compared to the currently used mobile store system of multiple stand-alone applications, our solution targets specific services towards the users only when they need them.

These changes will push developers to think in terms of context awareness and therefore provide more personalized user experiences. From the point of view of the user, LLA gives the possibility to have a richer, open, and hands-free experience.

Another factor that we defended in this chapter is the sustainability and performance of our proposal regardless of the large diversity of possibilities existing inside the connected-environment of the user.

---

---

*Chapter 9 – Conclusions and future work*

---

The proposal presented in this Ph.D. work is an innovative concept. Proposing only ONE application per user, to perform all his/her tasks and manage transparently all the functionalities, is an ideal solution not available nowadays. The utopian future where mobile apps will know what we need, even before we interact with them, is approaching. In this sense, many research works are oriented to the development of those future apps and they found out that contextual awareness is essential to the survival of mobile applications.

Our proposal for this is called Long-life Application, a name that reflects the nature of the continuity and evolution that we demonstrate clearly in our scenario. This application will evolve while running according to the users' needs (personal and/or professional) and will provide continuously relevant context-adapted services.

A relevant aspect of the proposed application is the adequate detection of the context. For that purpose, the long-life application incorporates a rich situation model that considers any type of combination of three dimensions (time, location, and activity) to represent different context situations where users can be involved. Furthermore, it also incorporates an innovative cross-device context detection mechanism. This support for multiple devices enhances the capability to detect situations, anywhere and anytime, as data captured from different devices and sensors can be combined.

Moreover, LLA incorporates a dynamic injection mechanism allowing users, developers, and other entities, to expand the application and customize it according to the user's specific needs. This contribution presents the main novelty of our proposal in the mobile context-aware mobile world.

In a world where users are surrounded by smart objects, users have higher expectations from their apps. This evolution pushes the need to have an application able to consider the connected-world of the user. In this scope, LLA is able to deploy and distribute its services, if needed, among the different devices that the user is operating while hiding their heterogeneity by using Kalimucho.

To summarize, our proposal provides a mechanism able to detect, formalize and understand the user's context. It provides a set of components working simultaneously and transparently in order to inject, detect and understand situations regardless of its source. Also, it is a suitable solution for the common case of a user with multiple devices, as he/she is not obliged to manage only one specific device. It takes into account the multiplicity of devices and orchestrates the services of the application accordingly. It offers a new user experience that reflects the technological advances that we are witnessing every day.

Nonetheless, there is much work that could be done to improve LLA and make even more efficient for its users.

As future lines for this work, a process that identifies the semantics from either locations or events could be integrated. It should categorize them according to different semantic domains (sport, lifestyle, entertainment, etc.) in order to infer appropriate services.

Another major improvement that could be considered to improve the dynamicity of the application would be to integrate an intelligent situation recommender based on machine/deep learning based algorithm that digs deeper into the personality of the user in order to propose more personal situations.

Moreover, with the advancement of technology and the riser of green and energy-aware computing, we must take into consideration this important area which is in the center of smart-environments. This perspective could bring LLA to next age of power-efficiency and present to the world as an application that deeply cares about the environment.

Last but not least, we cannot discuss IoT without bringing the issue of security. The security issue is a non-ending conflict between hackers and programmers. Although LLA uses Kalimucho's encryption-key system to securely transfer data, it lacks its own security layers and protocols that ensure the anonymity and protection of a user possessing multiple devices inside a non-secured network. This is an important issue to consider to its importance for every user, especially when he is managing more than one device and when he relies most of the time on information transfer between his/her devices.

LLA proposal, somehow, may imply a revolution in the way we interact with computers, as we propose a single long-life application that adapts itself dynamically to the current situation. This application is still on a prototype level based on thorough research on the related domains. But the promising results that we acquired made us consider pushing it to a commercial level and contacting possible investors and providers.



## *Bibliography*

- [1] 24me, <https://www.twentyfour.me/> [Online; accessed 06-December-2017].
- [2] Akman, Varol, and Mehmet. S. "The use of situation theory in context modeling." *Computational Intelligence: An International Journal* 13.3: 427-438. 1997.
- [3] Amy L. Murphy, Gian Pietro Picco, Gruia-Catalin Roman, LIME: A Middleware for Physical and Logical Mobility, Proceedings of the 21st International Conference on Distributed Computing, 524—533, 2001.
- [4] Antero. T, Tommi. M, and Kari Systä. Liquid software manifesto: the era of multiple device ownership and its implications for software architecture. In 38th Annual Computer Software and Applications Conference (COMPSAC), pages 338–343. IEEE, 2014.
- [5] AppAnnie, App Annie 2016 Retrospective Research\Analyze, 2017.
- [6] Apple, <https://www.apple.com/tn/imac/> [Online; accessed 06-December-2017].
- [7] Audi, <http://www.audi.fr/fr/web/fr/gamme/a3/a3.html> [Online; accessed 06-December-2017].
- [8] Autili, Marco, Paola Inverardi, and Massimo Tivoli. "CHOREOS: large scale choreographies for the future internet." Software Maintenance, Reengineering and Reverse Engineering (CSMR-WCRE), 2014 Software Evolution Week-IEEE Conference on. IEEE, 2014.
- [9] Bailey, James, et al. "An event-condition-action language for XML." Web Dynamics. Springer Berlin Heidelberg. 223-248. 2004.
- [10] Bakken, David. "Middleware." *Encyclopedia of Distributed Computing* 11” (2001).
- [11] Ben Abdesslem, F., Phillips, A., & Henderson, T. (2009, August). Less is more: energy-efficient mobile sensing with senseless. In Proceedings of the 1st ACM workshop on Networking, systems, and applications for mobile handhelds (pp. 61-62). ACM.
- [12] Boujbel, Raja, et al. "MuscaDel: A deployment dsl based on a multiscale characterization framework." Computer Software and Applications Conference Workshops (COMPSACW), 2014 IEEE 38th International. IEEE, 2014.
- [13] Cecilia Mascolo, Licia Capra, Stefanos Zachariadis and Wolfgang Emmerich, xmiddle: A Data-Sharing Middleware for Mobile Computing, Wireless Personal Communications, 77—103, 2002
- [14] Cheverst, Keith and Davies, Nigel and Mitchell, Keith and Friday, Adrian and Efstratiou, Christos. Developing a context-aware electronic tourist guide: some issues and experiences. Proceedings of the SIGCHI conference on Human Factors in Computing Systems, pages 17—24. ACM, 2000.
- [15] CHEN, P.-S. The entity-relationship model - toward a unified view of data. ACM Transaction on Database Systems 1, 1, 9–36. 1976.

- [16] Chia-Chen Chen and Tien-Chi Huang. Learning in a u-museum: Developing a context-aware ubiquitous learning environment. *Computers & Education*, 59(3):873–883, 2012.
- [17] CHTCHERBINA, E., AND FRANZ, M. Peer-to-peer coordination framework (p2pc): Enabler of mobile ad-hoc networking for medicine, business, and entertainment. In *Proceedings of International Conference on Advances in Infrastructure for Electronic Business, Education, Science, Medicine, and Mobile Technologies on the Internet (SSGRR2003w)*, 2003.
- [18] Clarke, Siobhán, and Cormac Driver. "Context-aware trails [mobile computing]." *Computer* 37.8: 97-99. 2004.
- [19] Clarke, Cormac Driver Siobhán. "Hermes: Generic Designs for Mobile, Context-Aware Trails-Based Applications.» 2004.
- [20] Coding Horror, <https://blog.codinghorror.com/lazyweb-calling/> [Online; accessed 06-December-2017].
- [21] Crunchbase, <https://www.crunchbase.com/organization/grokr#/entity> [Online; accessed 06-December-2017].
- [22] Crunchbase, <https://www.crunchbase.com/organization/osito#/entity> [Online; accessed 06-December-2017].
- [23] Da, Keling, Marc Dalmau, and Philippe Roose. "Kalimucho: Middleware for mobile applications." *Proceedings of the 29th Annual ACM Symposium on Applied Computing*. ACM, 2014.
- [24] Dave Evans. *The internet of things: How the next evolution of the internet is changing everything*. Technical report, Cisco, 2011.
- [25] David, Pierre-Charles, and Thomas Ledoux. "WildCAT: a generic framework for context-aware applications." *Proceedings of the 3rd international workshop on Middleware for pervasive and ad-hoc computing*. ACM, 2005.
- [26] de Oliveira, L., and A. Loureiro. "CodeDroid: A Framework to Develop Context-Aware Applications." *The Fourth International Conferences on Advances in Human-oriented and Personalized Mechanisms, Technologies, and Services*. 2011.
- [27] Dey, Anind K., Gregory D. Abowd, and Andrew Wood. "CyberDesk: A framework for providing self-integrating context-aware services." *Knowledge-Based Systems* 11.1: 3-13. 1998.
- [28] D. Gelernter. *Generative Communication in Linda*. *ACM Computing Surveys*, 7(1):80–112, Jan. 1985.
- [29] Edison.tech <https://www.easilydo.com/> [Online; accessed 06-December-2017].
- [30] Elmalaki, Salma, Lucas Wanner, and Mani Srivastava. "Caredroid: Adaptation framework for android context-aware applications." *Proceedings of the 21st Annual International Conference on Mobile Computing and Networking*. ACM, 2015.
- [31] Endsley, M. R., Bolte, B., & Jones, D. G. *Designing for situation awareness: an approach to user-centered design*. Boca Raton, FL: CRC Oress. 2003.

- [32] E. Bouix, M. Dalmau, P. Roose F. Luthon - A Multimedia Oriented Component Model - AINA 2005 - The IEEE 19th International Conference on Advanced Information Networking and Applications - Tamkang University, Taiwan - March 28 - March 30, 2005.
- [33] E. Bruneton, T. Coupaye, M. Leclercq, V. Quema, and J.-B. Stefani, I. Crnkovic, J. A. Stafford, H. W. Schmidt, and K. Wallnau, An open component model and its support in java. In Proceedings of the 7th International Symposium on Component-Based Software Engineering (CBSE 2004), volume 3054, pages 7–22, Edinburgh, Scotland, Springer-Verlag. 2004.
- [34] Fatoohi, Rod, David McNab, and David Tweten. "Middleware for Building Distributed Applications Infrastructure." *Report NAS-97-026*, 1997.
- [35] Floch, J., Hallsteinsen S., Stav E., Eliassen E., Lund K., Gjørven E.: Using architecture models for runtime adaptability. *IEEE Software*, 23, 2, 62–70. 2006.
- [36] Flybits, <https://flybits.com/> [Online; accessed 06-December-2017]
- [37] Forbes, <https://www.forbes.com/sites/joshbersin/2012/08/16/the-move-from-systems-of-record-to-systems-of-engagement/#72fdafe647f5> [Offline; accessed 06-December-2017].
- [38] Gheith, A., et al. "IBM Bluemix Mobile Cloud Services." *IBM Journal of Research and Development* 60.2-3: 7-1. 2016.
- [39] Glassey, R., Stevenson, G., Richmond, M., Nixon, P., Terzis, S., Wang, F., Ferguson R. I.: Towards a Middleware for Generalised Context Management. First International Workshop on Middleware for Pervasive and Ad Hoc Computing, *Middleware*, 2003.
- [40] Google, <https://www.google.com/intl/fr/landing/now/> [Online; accessed 06-December-2017]
- [41] Google, <https://developer.android.com/topic/instant-apps/overview.html> [Online; accessed 06-December-2017].
- [42] Google Play, <https://play.google.com/store/apps/details?id=ru.gavrikov.mocklocations&hl=fr> [Online; accessed 06-December-2017].
- [43] GRUBER, T. G. A translation approach to portable ontologies. *Knowledge Acquisition* 5, 2, 199–220. 1993.
- [44] Chihani, B., Bertin, E., & Crespi, N. A user-centric context-aware mobile assistant. In *Intelligence in Next Generation Networks (ICIN)*, 2013 17th International Conference on (pp. 110-117). IEEE. 2013.
- [45] GsmArena, [http://www.gsmarena.com/samsung\\_gear\\_s3\\_classic-8309.php](http://www.gsmarena.com/samsung_gear_s3_classic-8309.php) [Online; accessed 06-December-2017].
- [46] GsmArena, [http://www.gsmarena.com/samsung\\_i9500\\_galaxy\\_s4-5125.php](http://www.gsmarena.com/samsung_i9500_galaxy_s4-5125.php) [Online; accessed 06-December-2017].
- [47] Gu, Tao, et al. "An ontology-based context model in intelligent environments." *Proceedings of communication networks and distributed systems modeling and simulation conference*. Vol. 2004. 2004.

- [48] G. D. Abowd: “Software Engineering Issues for Ubiquitous Computing” Int. Conf. on Software Engineering, Los Angeles, 1999.
- [49] G. D. Abowd and E. D. Mynatt, “Charting past, present, and future research in ubiquitous computing”, *ACM Trans. Comput.-Hum. Interact.* 7, 1, Pages 29 – 58, 2000.
- [50] Hadim, Salem, and Nader Mohamed. "Middleware: Middleware challenges and approaches for wireless sensor networks." *IEEE distributed systems online* 7.3: 2006.
- [51] HALPIN, T. A. *Information Modeling and Relational Databases: From Conceptual Analysis to Logical Design*. Morgan Kaufman Publishers, San Francisco, 2001.
- [52] Harter, A., Hopper, A., Steggle, P., Ward, A., & Webster, P. (2002). The anatomy of a context-aware application. *Wireless Networks*, 8(2/3), 187-197.
- [53] Hofer, T., Schwinger, W., Pichler, M., Leonhartsberger, G., Altmann, J., & Retschitzegger, W. Context-awareness on mobile devices-the hydrogen approach. In *System Sciences, 2003. Proceedings of the 36th Annual Hawaii International Conference on* (pp. 10-pp). IEEE. 2003.
- [54] Hp Customer Support, <https://support.hp.com/ca-en/document/c05349072> [Online; accessed 06-December-2017].
- [55] INDULSKA, J., ROBINSONA, R., RAKOTONIRAINY, A., AND HENRICKSEN, K. Experiences in using cc/pp in context-aware systems. In *LNCS 2574: Proceedings of the 4th International Conference on Mobile Data Management (MDM2003)*, M.-S. Chen, P. K. Chrysanthis, M. Sloman, and A. Zaslavsky, Eds., *Lecture Notes in Computer Science (LNCS)*, Springer, pp. 247–261. 2003.
- [56] Israel J. Mojica, Bram Adams, Meiyappan Nagappan, Steffen Dienst, Thorsten Berger, Ahmed E. Hassan, A Large Scale Empirical Study on Software Reuse in Mobile Apps, *IEEE Software* Vol. 31 No. 2 Pg. 78--86, 2014.
- [57] Jeffrey S. Pierce and Jeffrey Nichols. An infrastructure for extending applications' user experiences across multiple personal devices. In *Proceedings of the 21st annual ACM symposium on User interface software and technology (UIST '08)*. ACM, New York, NY, USA, 101-110, 2008.
- [58] João Pedro Sousa and David Garlan, *Aura: An Architectural Framework for User Mobility in Ubiquitous Computing Environments*, *Software Architecture: System Design, Development and Maintenance*, World Computer Congress, Conference on Software Architecture, August 25-30, Montreal, Canada, 2002.
- [59] Karchoud, R., Roose, P., Dalmau, M., de Courchelle, I., & Dibon, P. (2015, March). Kalimucho for smart-\*. One step towards eternal applications. In *Industrial Technology (ICIT), IEEE International Conference on* (pp. 2426-2432). 2015.
- [60] Karchoud, R., Roose, P., Dalmau, M., Illaramendi, A., & Ilarri, S. Long Life Application: Approach for User Context Management and Situation Understanding. In *Ubiquitous Computing and*

Communications and 2016 International Symposium on Cyberspace and Security (IUCC-CSS), International Conference on (pp. 45-53). IEEE. 2016.

[61] Karchoud, R, ILLARRAMENDI, A, ILARRI, S, et al. Long-life application. *Personal and Ubiquitous Computing*, p. 1-13, 2017.

[62] Karchoud, R, et al. "All for One and One For All: Dynamic Injection of Situations in a Generic Context-Aware Application." *Procedia Computer Science* 113: 17-24, 2017.

[63] Ke Zhai and Boni Xu and W. K. Chan and T. H. Tse, CARISMA: a context-sensitive approach to race-condition sample- instance selection for multithreaded applications, 221—231, International Symposium on Software Testing and Analysis, {ISSTA}, 2012, Minneapolis, MN, USA, July 15-20, 2012.

[64] Khan, Zaheer, Saad Liaquat Kiani, and Kamran Soomro. "A framework for cloud-based context-aware information services for citizens in smart cities." *Journal of Cloud Computing* 3.1 (2014): 14.

[65] Knappmeyer, Michael, et al. "Survey of context provisioning middleware." *IEEE Communications Surveys & Tutorials* 15.3: 1492-1519, 2013.

[66] La, Hyun Jung, and Soo Dong Kim. "A conceptual framework for provisioning context-aware mobile cloud services." *Cloud Computing (CLOUD)*, 2010 IEEE 3rd International Conference on. IEEE, 2010.

[67] MCCARTHY, J. Notes on formalizing contexts. In *Proceedings of the Thirteenth International Joint Conference on Artificial Intelligence*, R. Bajcsy, Ed., Morgan Kaufmann, pp. 555–560, 1993.

[68] MCCARTHY, J., AND BUVAC<sup>~</sup>. Formalizing context (expanded notes). In *Working Papers of the AAAI Fall Symposium on Context in Knowledge Representation and Natural Language*, S. Buvac<sup>~</sup> and Ł. Iwanska, ' Eds., American Association for Artificial Intelligence, American Association for Artificial Intelligence, pp. 99–135, 1997.

[69] Microsoft, <https://developer.microsoft.com/fr-fr/windows/kinect/hardware> [Online; accessed 06-December-2017].

[70] Microsoft, <https://www.microsoft.com/fr-fr/surface/devices/surface-pro-4/overview> [Online; accessed 06-December-2017].

[71] Matthew Panzarino. Foursquares swarm and the rise of the invisible app. <https://www.techcrunch.com/2014/05/15/ foursquares-swarm-and-the-rise-of-the-invisible-app>, 2014. [Online; accessed 06-December-2017].

[72] Mobile News, John, 5th June 2014, <http://www.appmachine.com/blog/apps-service-moving-mobile-cloud/> [Online; accessed 06-December-2017].

[73] MrCoffee, <http://www.mrcoffee.com/wemo-landing-page.html> [Online; accessed 06-December-2017].

[74] M. Weiser: "The Computer for the 21st Century", *Scientific American*, 265, 3, September 1991.

[75] Nakamichi, <https://www.nakamichi-usa.com/> [Online; accessed 06-December-2017].

- [76] Nakagawa, T., Doi, C., Ohta, K., & Inamura, H.. Customizable Context Detection for ECA rule-based Context-aware Applications. *ICMU, May, 30*, 60. 2012.
- [77] Nest, <https://nest.com/smoke-co-alarm/tech-specs/> [Online; accessed 06-December-2017].
- [78] Nest, <https://nest.com/fr/cameras/nest-cam-iq-indoor/overview/> [Online; accessed 06-December-2017].
- [79] Omer B, Victoria B, and Henning S. Bridging communications and the physical world: Sense everything, control everything. In *GLOBECOM Workshops*, pages 1735–1740. IEEE, 2010.
- [80] Ovadia, S. "Automate the internet with “if this then that” (IFTTT)." *Behavioral & Social Sciences Librarian* 33.4: 208-211, 2014.
- [81] Perera, C, et al. "A survey on internet of things from industrial market perspective." *IEEE Access* 2: 1660-1679, 2014.
- [82] Perera, C, et al. "Context aware computing for the internet of things: A survey." *IEEE Communications Surveys & Tutorials* 16.1, 414-454, 2014.
- [83] P.-C. David. Développement de composants Fractal adaptatifs : un langage ddi l’aspect d’adaptation. Phd thesis, Université de Nantes école des Mines de Nantes, July 2005.
- [84] Romero, Daniel, et al. "An sca-based middleware platform for mobile devices." *Enterprise Distributed Object Computing Conference Workshops, 2008 12th. IEEE, 2008*.
- [85] R. Balter, S. Krakowiak , Bilan des activités du laboratoire et du pro jet Sirac , 18 décembre 2001, <http://lig-membres.imag.fr/krakowia/Files/Publi/bilan-sirac.pdf> [Online; accessed 06-December-2017].
- [86] Rouvoy, Romain, et al. "Composing components and services using a planning-based adaptation middleware." *International Conference on Software Composition. Springer Berlin Heidelberg, 2008*.
- [87] Samsung, <http://www.samsung.com/uk/business/interactive/education/> [Online; accessed 06-December-2017].
- [88] Scott Matteson, October 27, 2015 <http://www.techrepublic.com/article/mobile-apps-need-context-to-hit-the-right-targets/> [Online; accessed 06-December-2017]
- [89] Shalabi, S. M., Doll, C. L., Reilly, J. D., & Shore, M. B. U.S. Patent Application No. 13/311,278, 2011.
- [90] SHALABI, Sami M, DOLL, Cassandra Lynn, REILLY, James D., et al. Access control list. U.S. Patent Application No 13/311,278, 5. 2011.
- [91] Schilit B, Theimer M. Disseminating active map information to mobile hosts. *Network, IEEE.* 8(5):22–32. 1994.
- [92] SCHILIT, B. N., ADAMS, N. L., AND WANT, R. Context-aware computing applications. In *IEEE Workshop on Mobile Computing Systems and Applications (Santa Cruz, CA, US, 1994)*.

- [93] Sony, <https://www.sony.co.uk/electronics/support/televisions-projectors-lcd-tvs-android-/kdl-43w805c/specifications>, [Online; accessed 06-December-2017].
- [94] Sosinsky, Barrie. *Cloud computing bible*. Vol. 762. John Wiley & Sons, 2010.
- [95] Strang, T., Linnhoff-Popien, C.: *A Context Modeling Survey*. In: *Workshop on Advanced Context Modelling, Reasoning and Management, UbiComp, 2004*
- [96] Syer, Mark D., et al. "Exploring the development of micro-apps: A case study on the blackberry and android platforms." *Source Code Analysis and Manipulation (SCAM)*, 2011 11th IEEE International Working Conference on. IEEE, 2011.
- [97] Tempo, <https://tempo.io/mobile/> [Online; accessed 06-December-2017].
- [98] Tesla, <https://www.tesla.com/models> [Online; accessed 06-December-2017].
- [99] Todd Grennan. *Spring 2016 mobile customer retention report an analysis of retention by day*. Technical report, Appboy, 2016.
- [100] Tommi Mikkonen, Kari Systs, and Cesare Pautasso. *Towards liquid web applications*. In *International Conference on Web Engineering (ICWE)*, pages 134–143. Springer, 2015.
- [101] USCHOLD, M., AND GRUNINGER, M. *Ontologies: Principles, methods, and applications*. *Knowledge Engineering Review* 11, 2, 93–155. 1996.
- [102] Villamizar, Mario, et al. "Evaluating the monolithic and the microservice architecture pattern to deploy web applications in the cloud." *Computing Colombian Conference (10CCC)*, 2015 10th. IEEE, 2015.
- [103] W3C. *Composite Capabilities / Preferences Profile (CC/PP)*. <http://www.w3.org/Mobile/CCPP> [Online; accessed 06-December-2017]
- [104] Wang, Miao-Miao, et al. "Middleware for wireless sensor networks: A survey." *Journal of computer science and technology* 23.3: 305-326, 2008.
- [105] Wasinger, Rainer, et al. "Scrutable user models and personalized item recommendation in mobile lifestyle applications." *International Conference on User Modeling, Adaptation, and Personalization*. Springer Berlin Heidelberg, 2013.
- [106] WAPFORUM. *User Agent Profile (UAProf)*. <http://www.wapforum.org>. [Online; accessed 06-December-2017].
- [107] Weber, S. *Chromecast user's manual: stream video, music, and everything else you love to your TV*. Weber Systems Inc. 2014.
- [108] Yimeng Zhang. *16 Mobile Mistakes That Plummet User Retention Rates*. <https://apptimize.com/blog/2015/10/16-mobile-mistakes-that-plummet-user-retention-rates>, 2015, [Online; accessed 06-December-2017].
- [109] Yves Bouchard, *Contextual Logic and Epistemic Contexts*, Springer, 2014.

[110] Zachariadis, Stefanos, Cecilia Mascolo, and Wolfgang Emmerich. "Satin: a component model for mobile self organisation." *On the Move to Meaningful Internet Systems 2004: CoopIS, DOA, and ODBASE* : 1303-1321, 2004.

[111] Zhao, Zhenzhen, Ji Liu, and Noel Crespi. "The design of activity-oriented social networking: Dig-Event." *Proceedings of the 13th International Conference on Information Integration and Web-based Applications and Services*. ACM, 2011.



## *Appendix 1*

### Writing execution scripts

Components in a Kalimucho application are not launched by themselves. This is achieved by sending commands to the Kalimucho platform. This can be done either:

- By creating an initial deployment script file that will execute each time the application is launched
- By creating a component that uses the platform service to send commands the platforms.

The commands accepted by the platform are not solely to launch components, but can also connect components, remove components, migrate components, etc. Below is the full list of commands accepted by the platform and their parameters.

#### 1. List of commands

##### a. Creating a component

*CreateComponent name class [input input ...] [output output ...]*

- name = the name of the component (symbolic name used by the platform to name it)
- class = the class of the component on the form: application.package...nameOfTheClass
- [input ...] = list of the names of the connectors linked to the inputs of the component (will be [null] if the component as no input). Each element of the list can be :
  - a name of connector if only one connector is linked to this input
  - {c1 c2 ... cN} if connectors c1, c2, ... cN are connected to this input
  - "not\_used" if the input is, for the moment, not connected. It can be connected later.
- [output ...] = list of the names of the connectors linked to the outputs of the component (will be [null] if the component as no output). Each element of the list can be :
  - a name of connector if only one connector is linked to this output
  - {c1 c2 ... cN} if connectors c1, c2, ... cN are connected to this output
  - "not\_used" if the output is, for the moment, not connected. It can be connected later.

The component is created. The connectors can be indifferently created before or after the component. A component with no input and no output can be also created (the two last parameters are [null] [null]).

➔Remark: More connectors can be added later to the created component thanks to the commands `ReconnectInputComponent` and `DuplicateOutputComponent`.

Example: CreateComponent navigator application.nav.gps.Navigator [fromGPSReader fromSupervisor] [{toLogger toSupervisor}]

### **b. Removing a component**

*RemoveComponent name*

- name = the name of the component (symbolic name used by the platform to name it)
- The component is stopped then removed; the connectors to which it was linked are only disconnected and can be destroyed or connected again.

Example: RemoveComponent navigator

### **c. Component migration**

*SendComponent name to*

- name = the name of the component (symbolic name used by the platform to name it)
- to = name of the device to send this component to. A name is constituted of a friendly name defined by the device's user followed by a : followed by the type of the device (PC or Android) followed by a unique number.

The component is stopped then its internal state is sent by serialization. The platform which sends the component also executes the redirection of all the linked connectors to the new device. The sent component will not execute the init method but will directly start in the run\_BC method.

➔Example: SendComponent navigator Kalimucho:Android50CCF8C78679

### **d. Disconnection of an input of a component**

*DisconnectInputComponent name number designation*

- name = the name of the component (symbolic name used by the platform to name it)
- number = the number of the input to reconnect (zero-based)
- designation = the name of the input connector to disconnect

An input connector of the component is disconnected. The component will be suspended if it tries to read on this input and if there is no more linked connector remaining. It will be restarted and terminate its reading when this input will be connected again and provides new data.

➔Example: DisconnectInputConnector navigator 1 fromSupervisor

### e. Reconnection of an input of a component

*ReconnectInputComponent name number input*

- name = the name of the component (symbolic name used by the platform to name it)
- number = the number of the input to reconnect (zero-based)
- input = the name of the connector to connect to this input

Adds a connector on an input of the component. If the component was suspended while reading on this input, it will be restarted when a new data will be available on the connector.

→Example: ReconnectInputComponent navigator 1 fromSupervisor

### f. Disconnection of an output of the component

*DisconnectOutputComponent name number output*

- name = the name of the component (symbolic name used by the platform to name it)
- number = the number of the input to disconnect (zero-based)
- output = the name of the output connector to disconnect

An output connector of the component is disconnected. According to the method used by the component to write on this output, it can be suspended if there is no more linked connector remaining. It will be restarted and terminate its writing when this output will be connected again.

→Example: DisconnectOutputComponent navigator 2 toLogger

### g. Reconnection or duplication of an output of the component

*DuplicateOutputComponent name number output*

- name = the name of the component (symbolic name used by the platform to name it)
- number : the number of the output to connect or duplicate (zero-based)
- output = the name of the connector to connect or add to this output

Adds a connector on an output of the component. If there was yet at least one connector linked to this output, the platform only duplicates output data in this new connector.

→Example: DuplicateOutputComponent navigator 0 toLogger

### h. Creation of a connector

*CreateConnector name input output*

- name = the name of the connector (symbolic name used by the platform to name it)

- input = "internal" or the name of the device from which this connector arrives.
- output = "internal" or the name of the device to which this connector goes

A device name is constituted of a friendly name defined by the device's user followed by a : followed by the type of the device (PC or Android) followed by a unique number.

This command creates a connector. The word "internal" indicates that this end of the connector is on the device that creates it. The name of a device is used when this connector comes or goes to another device. In this case, the local platform sends a command to the distant one in order it creates the other part of the connector.

→Example: CreateConnector fromSupervisor internal Kalimucho:Android50CCF8C78679

### **i. Removing a connector**

*RemoveConnector name*

- name = the name of the connector (symbolic name used by the platform to name it)
- The connector is removed.

If the input or the output of this connector is on another device, the local platform sends a command to the distant platform in order it removes its part of the connector.

→Example: RemoveConnector toLogger

## **2. Writing an initial deployment file**

An initial deployment file will be executed each time the application launches, inside this file, you can define a list of commands that the platform will process when it starts.

The initial deployment file name is init.txt this file needs to be:

- \_ In the Kalimucho/KalimuchoInitialDeployment folder of a PC application
- \_ In the assets/Kalimucho/KalimuchoInitialDeployment folder of an Android application

The file is constituted of blocks of commands describing deployments. The empty lines or the lines starting with # are ignored. A block of commands can be put between tags indicating when it must be executed. The tag normally contains the name of a device and the command will be executed as soon as this device will be present on the network.

- An opening tag is the name of a device or \* between < and >
- A closing tag is the name of a device or \* between </ and >

Commands that are not enclosed in tags are non-conditional commands which will be immediately executed.

Commands enclosed in tags are executed as soon as the device named in the tag is present. If the named device is \* these commands are executed at each arrival of a new device.

A command a can be preceded by the name of a device or \* followed by: (this command will be executed by the platform of this device, \* will be replaced by the name of the newly detected device).

A command without a name of the device followed by: is a command executed by the local platform. When a device is indicated in a command, it can be:

- The name of a machine (as defined by the user)
- \* that will be replaced by the name of the new detected device
- localDevice that indicates the device which executes the initial deployment.

In order to avoid components and connector name duplications, a name that contains the character \* in a command will be replaced by this name completed by the name of the device indicated in the tag in which this command is included or by the name of the newly detected device if the tag is <\*> or, at last, by "localDevice" if this command is outside of tags.

After what, the names really used by the platform will be, moreover, completed by the name of the device that executes the initial deployment. This in order to avoid duplications of names due to the execution of the same deployment file on several devices.

The usable commands are the following:

- CreateComponent namec classe [namek namek ...] [namek namek ...]
- CreateConnector namek device device
- DisconnectInputComponent namec namek
- DisconnectOutputComponent namec namek
- ReconnectInputComponent namec numero namek
- ReconnectOutputComponent namec numero namek

Remarks:

- In these commands the names (namec and namek) can include the character \* in order to be completed by the name of the device indicated in the tag.
- In these commands the names of devices (device) can be the name of a machine \* that is replaced by the name of the device indicated in the tag localDevice which is the name of the device executing the deployment internal for an internal end of connector.

Example of initial deployment file:

```
# Command executed locally: creation of local components
CreateComponent display application.display.Display [not_used not_used] [null]
```

```
CreateComponent transmit application.transmit.Transmitter [{c5}] [{c4}]
```

Remark: in these commands the names of the components (display and transmitter don't contain \* because this command is executed locally and only one time: at starting)

```
# Commands executed when the device called "Example" is present
# The first and the third are executed by the device called "Example"
<Example>
Nexus: CreateComponent rec application.receive.Receive [{c4}] [{c5}]
CreateConnector c5 Example internal
Example: CreateConnector c4 localDevice internal
</Example>
```

Remark: in these commands the names of components and connectors (rec, c4 and c5 don't contain \* because this command is executed only one time: when the device called Example is present)

```
# Commands executed each time a new device is detected
# The first and the third are executed by the new device
# The others are executed by the local device
# In the last two commands the name of the component "display" matches the one
# created by a local command (see below), it does not change for each new device.
# On the other hand the connectors (c1 and c2) and the component (send) will have
# a different name for each detected device
<*>
*: CreateComponent send* application.send.Send [null] [{c1*} {c2*}]
CreateConnector c1* * internal
*: CreateConnector c2* internal localDevice
ReconnectInputComponent display 0 c1*
ReconnectInputComponent display 1 c2*
</*>
```