



HAL
open science

Series–Parallel Connection of Thyristors Triggered in Impact-Ionization Wave Mode

Ejlal Shahriari, Thomas Maysonnave, Anton Gusev, Antoine Silvestre de Ferron, Laurent Pecastaing

► **To cite this version:**

Ejlal Shahriari, Thomas Maysonnave, Anton Gusev, Antoine Silvestre de Ferron, Laurent Pecastaing. Series–Parallel Connection of Thyristors Triggered in Impact-Ionization Wave Mode. IEEE Transactions on Plasma Science, 2024, pp.1-8. 10.1109/TPS.2024.3377898 . hal-04528888

HAL Id: hal-04528888

<https://univ-pau.hal.science/hal-04528888>

Submitted on 2 Apr 2024

HAL is a multi-disciplinary open access archive for the deposit and dissemination of scientific research documents, whether they are published or not. The documents may come from teaching and research institutions in France or abroad, or from public or private research centers.

L'archive ouverte pluridisciplinaire **HAL**, est destinée au dépôt et à la diffusion de documents scientifiques de niveau recherche, publiés ou non, émanant des établissements d'enseignement et de recherche français ou étrangers, des laboratoires publics ou privés.



Distributed under a Creative Commons Attribution 4.0 International License

Series-Parallel Connection of Thyristors Triggered in Impact-Ionization Wave Mode

Ejlal Shahriari, *Graduate Student Member, IEEE*, Thomas Maysonnave, Anton I. Gusev, *Member, IEEE*, Antoine Silvestre de Ferron, Laurent Pecastaing, *Senior Member, IEEE*

Abstract—This paper demonstrates the impact-ionization switching of standard thyristors in a series-parallel configuration. The series-parallel triggering of thyristors holds a substantial promise for enhancing both voltage blocking and current capacity of the switch simultaneously. Nevertheless, the key obstacle in this context revolves around acquiring a suitable trigger generator, primarily because this trigger necessitates a combination of high dV/dt and low post-triggering energy to be applied to the thyristor assembly. Thus, a novel trigger circuit is developed to test a setup with two parallel branches, each having two series-connected thyristors (with a wafer diameter of $\text{\O}24$ mm and a rated blocking voltage of 1.8 kV). These thyristors were tested in the impact-ionization switching mode using a single Marx generator. We conducted experiments in a current flow phase, where energy switching occurred by connecting an RLC discharge circuit. These experiments revealed that the thyristors transitioned from a blocking to a conducting state around ~ 400 ps, enabling the switching of a current pulse with an amplitude of ~ 17.5 kA and a dI/dt of ~ 8.5 kA/ μs (limited by the circuit). Notably, the current imbalance between the thyristor parallel branches remained under 2%. To the best of our knowledge, this is the first reported instance of successfully triggering high-voltage thyristors connected in series-parallel in the impact-ionization wave mode.

Index Terms—High dI/dt , impact-ionization wave mode, Marx generator, pulsed power systems, subnanosecond switching time, thyristors.

I. INTRODUCTION

THE impact-ionization breakdown in silicon pn junction was discovered in 1979 [1]. The utilization of impact-ionization switching in high-voltage thyristors, as demonstrated later in [2], presents a favorable technique for switching in pulsed power applications. This approach significantly boosts the current-handling capacity of standard thyristors, allowing for the switching of a high current pulse with a high rise rate (i.e., 100s kA and 10s kA/ μs). The primary distinction in the control method between impact-ionization switching and conventional thyristor switching is emphasized as follows. On the one hand, in a standard switching mechanism, a voltage pulse is applied to the gate electrode with respect to the

cathode of the thyristor. This results in a switching time of a few tens of nanoseconds and a limited dI/dt of ~ 1 kA/ μs . On the other hand, to initiate the impact-ionization switching mechanism, a steep overvoltage pulse is applied across the anode and cathode, as the gate electrode remains floating. This overvoltage pulse has a rise rate greater than ~ 1 kV/ns and an amplitude of at least twice of static voltage breakdown (V_0) [3]. Under these conditions, subnanosecond switching time and the possibility to switch high currents with high dI/dt (100s kA, 10s kA/ μs) are obtainable.

Employing high current/high dI/dt switches has possible applications in various research areas, including inertial fusion [4], X-pinch [5], [6], and high-energy-density physics [7]. Furthermore, numerous industrial uses, such as magnetic pulse forming, welding, rock fracturing [8], and mining, demand the generation of high-current pulses in the range of hundreds of kiloamperes [9].

Extensive research has been carried out on semiconductor switches to address the need for high currents (100s kA) and to handle extremely rapid current rise rates (10s kA/ μs), as presented in [2], [10]–[18]. These switches primarily rely on two technologies: reverse switching dynistors (RSDs) [10]–[16] and high-voltage thyristors operated in impact-ionization wave mode [2], [17], [18]. The literature suggests that impact-ionization switches demonstrate dI/dt exceeding 10 kA/ μs , while typical RSDs generally exhibit only a few kA/ μs at currents surpassing 100 kA.

The impact-ionization switching primarily depends on trigger generators, mainly due to the specific characteristics required for steep overvoltage triggering pulses. Trigger generators necessary for conducting such experiments can be categorized into three groups: (i) trigger generators utilizing opening switches, such as drift step-recovery diodes (DSRDs) [19] and semiconductor opening switches (SOS) [20]; (ii) spiral generators [21], [22]; and (iii) Marx generators [23]. While a low energy efficiency of around 30% is the main drawback of spiral generators, Marx generators main constraint is related to required modifications to reduce post-triggering energy applied to the switch(es). On the other hand, trigger generators based on semiconductor opening switches seem more reliable solution despite the fact that the commercial availability of DSRDs and SOS is limited. This stimulates research on off-the-shelf opening switch replacement [24], which has not yet yielded satisfactory results.

Series connection of thyristors serves as a technique for enhancing the blocking voltage of the switch. In accordance with findings presented in [2], a stack comprised of nine stan-

Manuscript received 24 November 2023; revised 26 January 2024; accepted 12 March 2024. This work was supported by the Framework of Energy and Environment Solutions (E2S) Université de Pau et des Pays de l'Adour (UPPA) Project [Solid-State Pulsed Power (S2P2) and Pulsed Power Applications (PULPA) Chairs] managed by the Agence Nationale de la Recherche (ANR) under Grant ANR-16-IDEX-0002.

Ejlal Shahriari, Thomas Maysonnave, Anton Gusev, Antoine Silvestre de Ferron, and Laurent Pecastaing are with the SIAME Laboratory, Université de Pau et des Pays de l'Adour, Pau, France. (e-mail: ejlal.shahriari@univ-pau.fr; thomas.maysonnave@univ-pau.fr; anton.gusev@univ-pau.fr; antoine.deferron@univ-pau.fr; laurent.pecastaing@univ-pau.fr).

standard high-voltage thyristors, triggered in the impact-ionization wave mode, featuring a blocking voltage of 20 kV and a wafer diameter of 40 mm, is capable of switching current pulses with an amplitude of 45 kA and a dI/dt of 134 kA/ μ s. In another study [18], encouraging outcomes were documented for a stack of two thyristors with a diameter of 56 mm. These thyristors exhibited a blocking voltage of 5 kV, and the current achieved an amplitude exceeding 200 kA, accompanied by a dI/dt exceeding 50 kA/ μ s and a full width at half maximum (FWHM) of 25 μ s. These outcomes underscore the potential of impact-ionization switching in commercial thyristors as a viable approach for constructing high-voltage and high-current semiconductor switches suited for pulsed power systems. Despite the literature covering high-voltage switches employing series-connected thyristors, research into high-current switches using parallel connection remains relatively limited.

In [25], the parallel switching of high-voltage thyristors (\emptyset 32 mm, 2.2 kV) has been demonstrated as a favorable process for achieving high-current switches. Parallel switching serves as a viable alternative to the triggering of a large-area thyristor (\emptyset 100 mm, 5.2 kV) [26]. This stems primarily from two reasons: (i) parallel switching is a more cost-effective solution, and (ii) it increases the current handling capability of the switch by eliminating limitations related to the wafer cross-sectional area.

This paper presents the impact-ionization switching of thyristors in series-parallel connection for the first time according to the open literature. The series-parallel triggering of thyristors is a promising method to increase voltage blocking and current capability of the switch simultaneously. This triggering method facilitates the research towards high-voltage and high-current switches in the pulsed power domain. In this study, we developed a novel trigger circuit to examine the performance of a setup consisting of two parallel branches. Each branch included two thyristors (with specifications of \emptyset 24 mm/1.8 kV, T123-320-18), connected in series. These thyristors were tested in the impact-ionization switching mode using a single Marx generator. In the upcoming section, we highlight the essential criteria for the trigger mechanism and discuss the enhancements that have been implemented. Afterward, the switching results of thyristors adopting this trigger are presented. Finally, we discuss the limitations of the Marx trigger generator using the trigger current measurement, which was performed for the first time.

II. EXPERIMENTAL SETUP ARRANGEMENT

The electrical diagram of the entire experimental setup, with trigger circuit, thyristor assembly, discharge circuit, and diagnostic components, is depicted in Fig. 1.

A. Trigger Generator Improvements

The trigger circuit design is enforced by the essential condition of impact-ionization switching of high-voltage thyristors, i.e., double static breakdown voltage with dV/dt of more than 1 kV/ns per thyristor. For two 1.8 kV thyristors connected in series, the trigger circuit must provide a pulse with an amplitude of more than 7.2 kV in less than 3.6 ns. Considering

thyristor before switching as an equivalent capacitance (C_{th}), to reach a higher value of dV/dt one needs a higher current of the trigger circuit. This can be derived from the definition of capacitance and charge as shown in (1).

$$\frac{dV}{dt} = \frac{I}{C_{th}} \quad (1)$$

The thyristor and the inductance L caused by the connection represent an LC-load for the trigger generator. In this case, the peak current I_{peak} of the trigger circuit can be expressed in (2) through the peaking module voltage V_p as described in [27].

$$I_{peak} = \frac{V_p}{\sqrt{\frac{L}{C_{th}}}} \quad (2)$$

Analyzing (2), one may conclude that a high peak current can be achieved through either reduction of the inductance of the trigger circuit loop or increasing applied voltage from the peaking module. The trigger loop inductance has been minimized by reducing the length of the connection and using a low-inductive capacitor in the peaking module. Thus, the Marx generator and peaking module were designed to reach $V_{p,max}$ of 70 kV ensuring a rise rate of more than 1 kV/ns across each thyristor. In this work, although the voltage across the peaking module reaches 70 kV, the voltage over the thyristor stack is limited to about twice the static breakdown voltage due to the impact-ionization switching mechanism, i.e., $(2 \times 1.8 \text{ kV}) \times 2 = 7.2 \text{ kV}$.

The different components of the trigger circuit and their applications can be highlighted as follows. A Marx generator is used to produce the high-voltage pulse, with a rise time of approximately 100 ns. Then, a peaking module sharpens the pulse to achieve rise times of more than 2 kV/ns. In order to decouple the trigger from the dc bias voltage V_0 and to allow a boost effect on the pulse an energy regulating unit is added to the trigger circuit. The energy regulating unit comprises of series capacitors (C_s) and grounding resistor (R_g). C_s is installed in the experimental setup to regulate the energy delivered to load from the trigger circuit. In addition, R_g is employed to charge C_s up to the charging voltage across C . This allows us to obtain a higher voltage with a higher dV/dt across the thyristors.

Based on the experimental results highlighted in [25], the post-trigger excessive energy in the Marx generator can damage thyristors after triggering. Thus, the first modification is to reduce the energy of the Marx generator. Compared to the MM4 Marx generator used in [25], [26], an equivalent capacitance has been reduced four times (up to 125 pF) in the new 8-stage Marx generator (TM8) which has a charging voltage of 20 kV and the energy of 1.6 J delivered to a load. In addition, the equivalent capacitance within the peaking module was reduced from 190 pF to 100 pF. Both measures - Marx generator energy reduction and peaking module capacitor changing - aimed at reducing energy delivered into the thyristors after switching.

Reducing the equivalent capacitance of the Marx generator affects the maximum voltage amplitude of the peaking module.

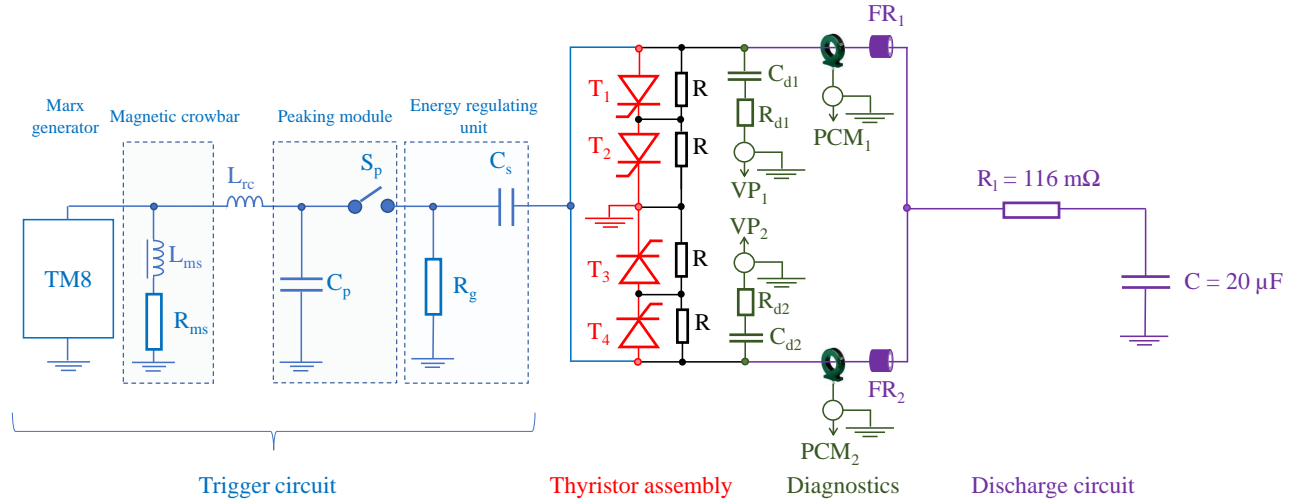

Fig. 1. Equivalent electrical circuit of the experimental arrangement.

To increase the maximum voltage amplitude of the internal capacitor of the peaking module C_p , an inductor L_{rc} was added for resonance charging.

Fig. 2 shows the voltage pulse waveform over the peaking module capacitor (C_p). Fig. 3 indicates that the useful zone of the pulse, with the highest amplitude, occurs during the first 100 nanoseconds. As it can be seen in Fig. 2, a part of the pulse with an amplitude about 30 kV is remained undamped. This can result in delivering excessive energy to the switch after triggering, potentially causing damage.

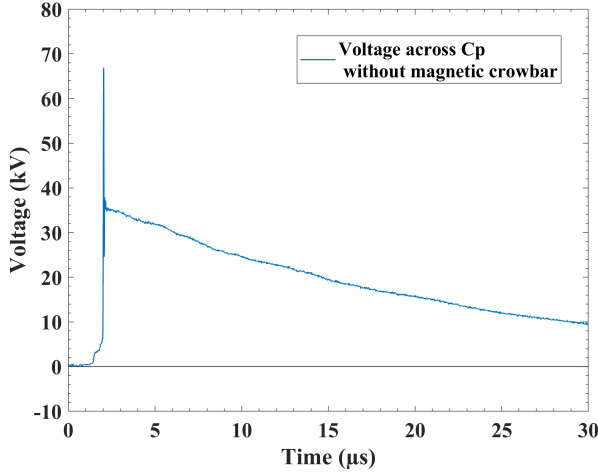

Fig. 2. Voltage pulse waveform across C_p without magnetic crowbar.

To reduce excessive post-triggering energy over thyristor assembly, a magnetic crowbar switch (L_{ms} and R_{ms} in Fig. 1) was designed as follows. Ferrite magnetic material was chosen due to its stability, cost-effectiveness, and low losses caused by eddy currents. The magnetic switch should close when the voltage across the peaking module capacitor reaches a maximum, thereby preventing the long part of the Marx generator output pulse from being applied to the thyristors. To achieve this goal, in the magnetic switch design, the number

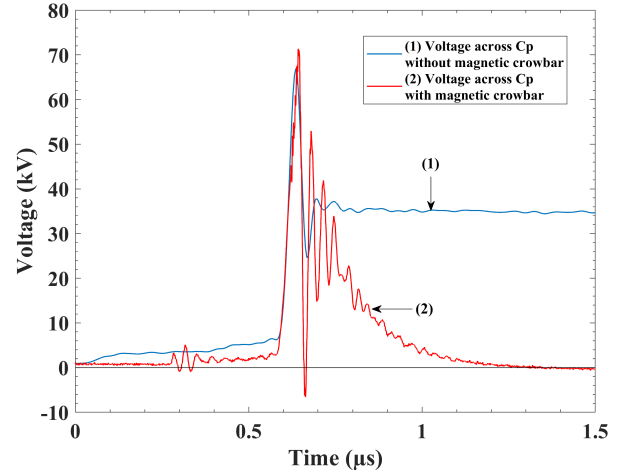

Fig. 3. Voltage pulse waveform across C_p , with and without magnetic crowbar.

of turns (N) and the total ferrite cross-sectional area (A_{Fe}) should be determined. Given the geometry of the ferrite rings (TX36/23/10, 3C90 by FERROXCUBE), and considering insulation limitations, the number of turns ($N = 12$) is chosen. Thus, to obtain A_{Fe} , a volt-second integral of the magnetic switch—described in [27]—derived from Faraday's Law is calculated as in (3).

$$N \times A_{Fe} \times \Delta B = \frac{V_{p,max} \times t_p}{2} \quad (3)$$

Given the maximum voltage of the peaking module ($V_{p,max} = 70$ kV), its charging time ($t_p = 100$ ns), and the magnetic induction swing ($\Delta B = 0.4$ T), the A_{Fe} is calculated as 730 mm². Since the effective cross-sectional area of one ferrite ring is 63 mm², the total number of ferrite rings employed in the magnetic switch is rounded to 12. For insulation purposes, the switch was divided into 6 parts connected in series, each consisting of 2 ferrite rings. Fig. 3

illustrates the effective application of the designed magnetic switch which significantly reduces the pulse duration without affecting the useful amplitude part.

B. Main Circuit

In this study, four standard thyristors of 24 mm, 1.8 kV (T123-320-18), were mounted in two parallel branches in which each branch includes two series thyristors. These thyristors have a rated blocking voltage of 1.8 kV and a wafer diameter of 24 mm. They are connected as shown in Fig. 1, labeled as T_1 , T_2 , T_3 and T_4 . When the voltage probe is connected to the thyristor in the original package, a large connection loop causes high parasitic inductance and reduces measurement accuracy. By placing the thyristor wafer inside a new customized package, which is smaller than the standard one, the connection loop of the voltage probe is minimized. Thus, we reduce the parasitic inductance and enhance the measurement accuracy. Additionally, the new packaging makes it easier to perform experiments by reducing the clamping force required. To prevent optical triggering of the thyristors, the new packages were 3D-printed using opaque plastic material, as illustrated in Fig. 4.

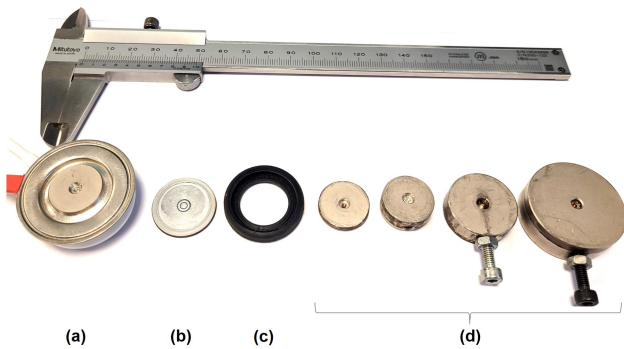

Fig. 4. Appearance of the T123-320-18 thyristor (1.8 kV / 24 mm): (a) original package, (b) thyristor wafer, (c) 3-D printed package, and (d) different employed connectors in thyristor assembly.

In order to ensure the dc voltage balance among four series-parallel thyristors, parallel resistors (R) of $7.5 \text{ M}\Omega$ are connected across each thyristor. This value of resistance is chosen to have a higher current flowing through the resistor compared to the leakage current of the thyristor consequently ensuring voltage balance among thyristors. Moreover, the current balance between two branches of parallel thyristors is obtained by applying a symmetrical geometry for the thyristor assembly and implementing identical parallel current paths in the discharging circuit.

The discharge circuit is constructed using a $20 \mu\text{F}$ capacitor bank (labeled as C), a load resistor (R_l , stainless-steel ribbon), and two parallel ferrite rings (labeled as FR), as shown in Fig. 1. The capacitor bank consists of two film capacitors ($10 \mu\text{F}$, 10 kV) connected in parallel. The grounded copper foil shield is applied to the film capacitors to minimize the discharge loop area, reducing its inductance and increasing the peak discharge current of the circuit. The discharge circuit

was designed based on a short circuit experiment (not shown), where the capacitor bank has been discharged using a switching spark gap. A discharge loop inductance of 123 nH was found from the short circuit test. To prevent the reverse current over the thyristors, a damping resistor is required. A resistance of $130 \text{ m}\Omega$ was found in the PSpice circuit simulation. We finally reduced this value to $116 \text{ m}\Omega$ to reach a higher forward thyristor current and dI/dt ; the small reverse current had no effect on the thyristors. Additionally, two parallel ferrite rings were included to isolate the triggering pulse from the discharge circuit.

The measurement system incorporates two parallel Pearson current monitors model 101 (PCM_1 and PCM_2 in Fig. 1) to measure current distribution among the two parallel branches of thyristors. Measuring the triggering voltage pulse is accomplished with two home-made wideband voltage probes (labeled as VP_1 and VP_2), each having a rise time of less than 350 ps . These voltage probes are based on a resistive divider, with a $1 \text{ k}\Omega$ ceramic resistor (R_{d1} and R_{d2}) as the high voltage arm and a 50Ω coaxial cable as the low voltage arm [28]. The cable braiding extends up to half of the $1 \text{ k}\Omega$ resistor to compensate for its parasitic inductance. To isolate the voltage probe from the bias voltage, 100 pF capacitors (C_{d1} and C_{d2}) are attached to the high voltage arms of the two probes. The voltage probe calibration process is detailed in [25].

The overall experimental setup in Fig. 1 operates as follows: The capacitor bank (C) is initially charged up to the bias voltage level of each parallel branch of the switch. Then, a triggering voltage pulse generated by the TM8 and enhanced by the peaking module is applied to the thyristor assembly. In this mode of triggering, the overvoltage pulse is applied to the main electrodes of thyristors when the gate terminal remains in the open state and connected to the cathode through internal resistance of about 8Ω . The energy delivered from the trigger generator is adjusted by the energy regulating unit and the magnetic crowbar system to safely operate the series-parallel connection of thyristors. Under this safe trigger condition, successful subnanosecond switching in impact-ionization wave mode is achieved. Finally, simultaneous closure of the two branches of thyristors generates a high-current pulse with a corresponding high dI/dt in the discharge circuit. In the following sections, the series-parallel switching results of thyristors in the impact-ionization wave mode are described in detail.

III. THYRISTOR SWITCHING RESULTS

The thyristor energy switching experiment is conducted for the configuration of two parallel branches, with each branch comprising two thyristors connected in series. The overall experimental setup is shown in Fig. 5. In this experiment, the capacitor bank (referred to as "C" in Fig. 1) is charged by an external dc voltage source up to 3.6 kV (the bias voltage over series-parallel connection of thyristors). Afterward, a steep overvoltage pulse generated by the trigger circuit is applied to the thyristor assembly. The triggering pulse for each branch of thyristors is measured independently using the high-frequency voltage probes described in Section II. The waveforms of these

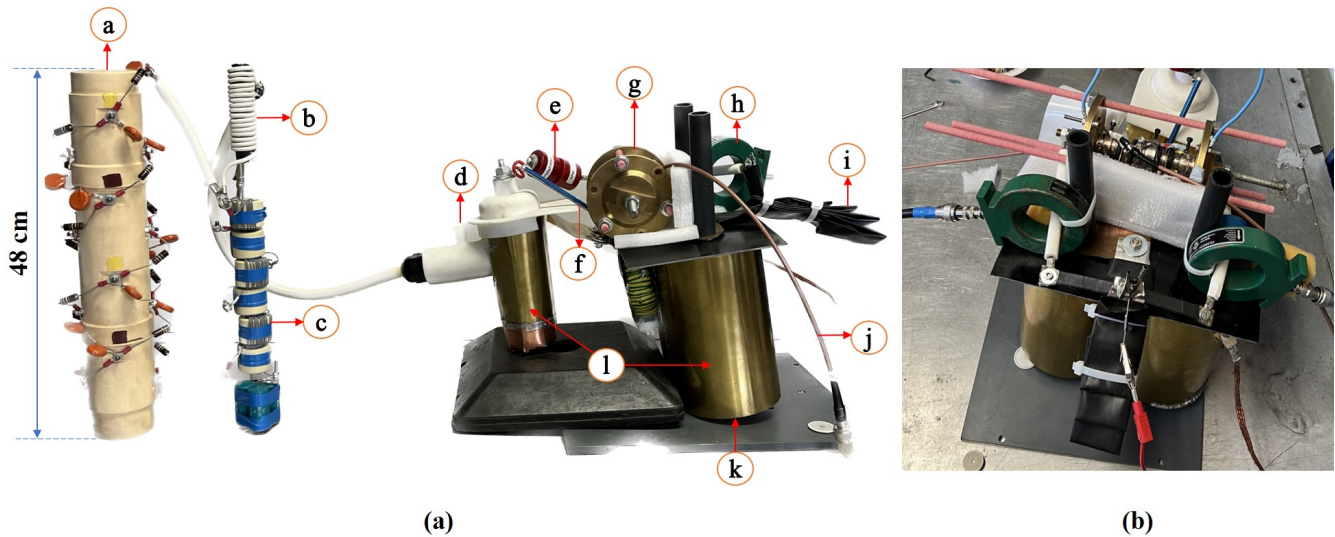

Fig. 5. Experimental setup for triggering series-parallel assembly of thyristors in impact-ionization mode with energy switching shown in (a) front view and (b) top view. Different component of the experimental setup are as follows: (a) TM8 Marx generator, (b) resonant inductor, (c) magnetic crowbar, (d) peaking module, (e) series capacitor of energy regulating unit, (f) resistor of energy regulating unit, (g) thyristor assembly, (h) Pearson current monitor (PCM), (i) resistive load, (j) wideband voltage probe, (k) capacitor bank, and (l) grounded copper foil shield.

triggering pulses are depicted in Fig. 6. These waveforms start with a dc bias voltage of 3.6 kV and are followed by pulses with rise rates (dV/dt) of ~ 2.5 kV/ns for the branch 1 (T_1 and T_2) and ~ 2.3 kV/ns for the branch 2 (T_3 and T_4), within the 10% to 90% transition range. The peak voltages reach ~ 7.6 kV and ~ 6.8 kV for the branch 1 and 2, respectively. Moreover, the switching times (10% to 90%) are measured as ~ 380 ps for the branch 1 and ~ 440 ps for the branch 2.

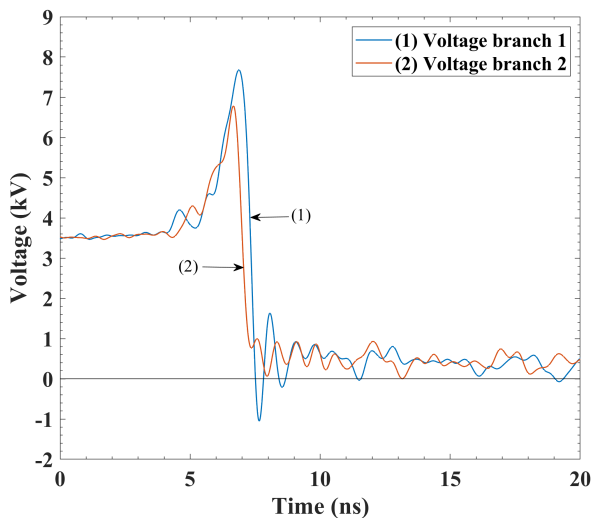

Fig. 6. Measured over voltage pulses across each thyristor branch (branch 1: T_1 and T_2 , and branch 2: T_3 and T_4).

Fig. 7 displays the waveforms of the current flowing through the series-parallel assembly of thyristors. The current measurement system includes two parallel Pearson current monitors to measure the current distribution between the two parallel-mounted thyristors branches. The total current flowing through

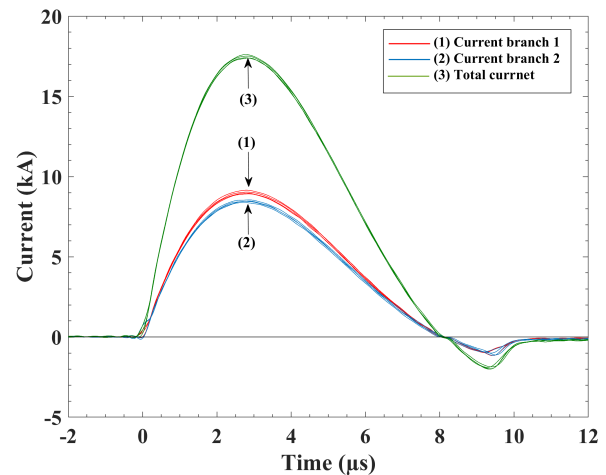

Fig. 7. Total current and current distribution over two thyristor branches (4-pulse overlap).

both thyristor branches has a rise rate (dI/dt) of ~ 8.5 kA/ μ s, reaches a peak amplitude of ~ 17.5 kA, and has a pulse duration of ~ 4.5 μ s as determined at FWHM.

The successful switching of series-parallel configuration of thyristors is accomplished through the following conditions: (i) compliance with the basic conditions of the impact-ionization switching (i.e., dV/dt more than 1 kV/ns and maximum voltage of triggering pulse twice that of static breakdown voltage) and (ii) low post-trigger energy delivered to the thyristor assembly, which can be seen as low residual voltage after switching (from ~ 8 ns to ~ 18 ns) in Fig. 6. In addition, equal current distribution between two parallel branches is obtained by implementing identical parallel current paths from the discharge circuit to the thyristor assembly.

By meeting the trigger pulse requirements and the geometry of the main circuit (including the discharge circuit and the thyristor assembly), a uniform distribution of current between two parallel branches is achieved, with a current variation of less than 2%, as demonstrated in Fig. 7.

Finally, we demonstrate the reproducibility of the experimental results, as it is illustrated in Fig. 7. After conducting these tests, the thyristor assembly exhibited a leakage current of $\sim 10 \mu\text{A}$ at the nominal voltage of 3.6 kV. This value remains consistent with the initial level (before the experiments), indicating that there is no observed degradation in the performance of the thyristors.

IV. STUDY OF THE THYRISTOR TRIGGERING CURRENT

In order to investigate the feasibility of the Marx generator to trigger thyristors in the impact-ionization wave mode, we arranged an experimental setup to measure fast triggering current. This experiment aims to find the reason for the residual voltage across the thyristor after the switching phase. We assume that a long pulse from the Marx trigger generator can lead to this residual voltage, which may eventually damage the thyristors. This experimental arrangement includes the trigger circuit, 1.8 kV Thyristor T_1 (T123-320-18), and diagnostics to measure overvoltage pulse and fast triggering current pulse as seen in Fig. 8. The triggering current through the thyristor is measured by a homemade resistive shunt (0.5Ω) with a usable rise time of about 0.5 ns [29]. Fig. 9 shows the stack assembly composed of the thyristor T_1 and the current shunt in series.

In this experiment, the thyristor T_1 is triggered in the impact-ionization wave mode with zero voltage bias. Fig. 10 shows the measured triggering current pulse and Fig. 11 illustrates the first few nanoseconds of the current and voltage waveforms on the thyristor. Based on these curves, we can draw two conclusions: (i) an alternating current is applied to the thyristor from the trigger generator, and (ii) there is a high current with high dI/dt flowing through the thyristor at the moment when the residual voltage is observed. This current is expected to have a high dI/dt due to a low-inductance path in the trigger circuit.

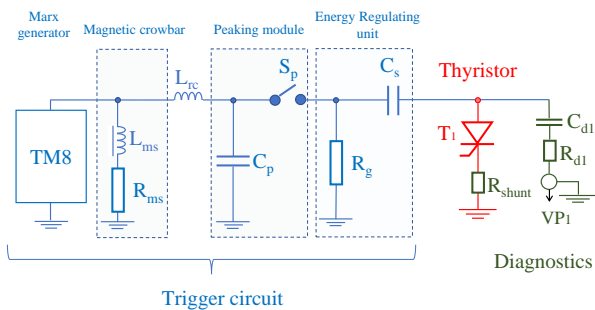

Fig. 8. Equivalent electrical circuit for the experiment of the thyristor triggering current measurement.

First, the fact that the current alternates between positive and negative values does not seem optimal for the thyristor closure

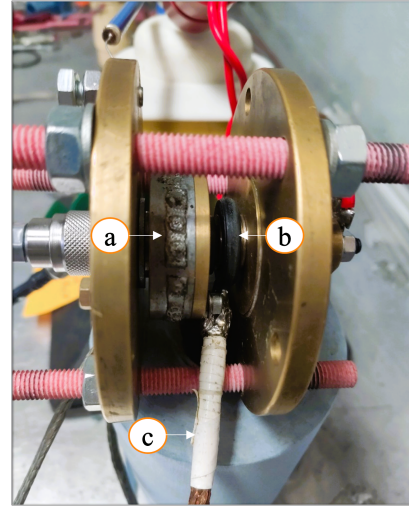

Fig. 9. The assembly of the thyristor T_1 and current shunt in series to measure the current during triggering phase. Different components are as follows: (a) shunt, (b) the Thyristor (T123-320-18), and (c) wideband voltage probe.

process. This is basically due to the capacitive elements of the trigger circuit (the Marx generator and the peaking module). On the one hand, high triggering current is required to initiate the impact-ionization switching mode. On the other hand, the capacitive nature of the trigger circuit results in oscillations (undamped response). Hence, it becomes highly challenging to remove the negative part without reducing the amplitude and rise time of the current.

Second, analyzing the initial nanoseconds and overlaying the current and voltage waveforms across the thyristor (Fig. 11), it is observable that once the thyristor switches, the current passing through it has a high amplitude ($\sim 1 \text{ kA}$) with a steep rise rate of more than $120 \text{ kA}/\mu\text{s}$. We assume such a high current with high dI/dt after switching leads to the residual voltage (in Fig. 11, from $\sim 3 \text{ ns}$ to $\sim 10 \text{ ns}$) which may cause damage on the thyristor.

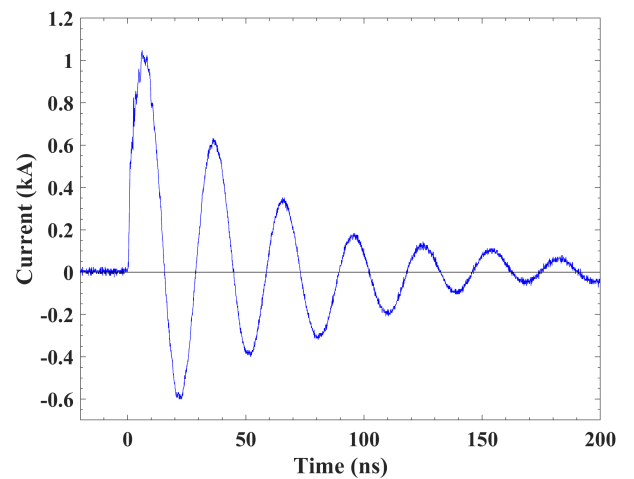

Fig. 10. Triggering current waveform delivered from the trigger to the thyristor T_1 .

Although experiments have demonstrated the successful

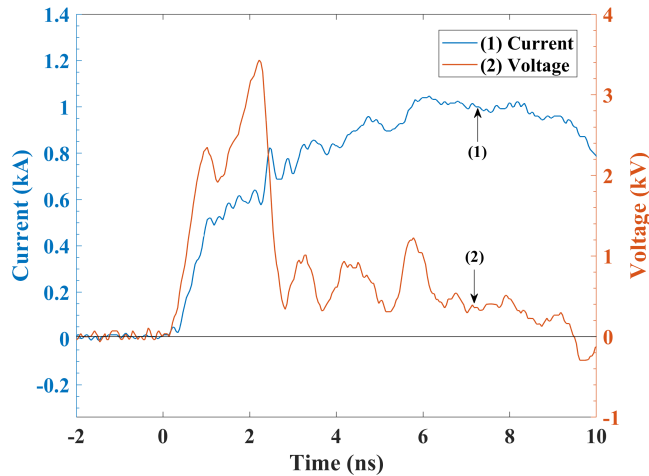

Fig. 11. A zoomed-in version of triggering current delivered from the trigger to the thyristor T_1 and voltage across the thyristor.

triggering of thyristors in the impact-ionization wave mode, the application of such triggering pulses utilizing the Marx generator system does not appear optimal. This is primarily attributed to the Marx generator triggering current pulse, which exhibits (i) damped sinusoidal characteristics and (ii) high current (1 kA) with a rise rate exceeding $120 \text{ kA}/\mu\text{s}$ after the switching phase. The magnetic crowbar introduced in this paper is not capable to solve this issue. Therefore, a triggering system based on inductive storage and semiconductor opening switch appears to be a more appealing alternative for the design of a trigger circuit. This trigger has several advantages over Marx generators, with notable benefits including the potential to achieve higher peak power and shorter pulse duration.

V. CONCLUSION

This paper has successfully demonstrated the impact-ionization switching of thyristors in the series-parallel configuration. This is accomplished through the design of a highly cost-effective trigger generator. This trigger generator consists of an improved Marx generator, magnetic crowbar, resonant inductance, peaking module and energy regulating unit. The peaking module and resonant inductance play a critical role in achieving a high dV/dt and high maximum voltage respectively. Meanwhile, the energy regulating unit and the magnetic crowbar system are the essential components as they guarantee the safe operation of the thyristors by restricting the excessive energy delivered after triggering. These significant modifications of conventional Marx generator enable the application of a trigger pulse with a substantial dV/dt level (2.5 kV/ns).

The work proves the possibility of impact-ionization triggering of the thyristor assembly (2 parallel branches of 2 series thyristors each) with current variations between the branches less than 2%. This important objective is accomplished using a single cost-effective trigger generator.

In terms of the constraints associated with the Marx generator, the high dI/dt immediately following the closure of the

thyristor, exceeding $120 \text{ kA}/\mu\text{s}$, coupled with a significant triggering current amplitude of 1 kA, underlines the nonoptimal nature of the trigger generator in use. Furthermore, the damped sinusoidal nature of the triggering current, resulting from the discharge triggered by capacitive elements within the peaking module, points to another less-than-ideal characteristic of such a trigger generator. Thus, a further research task involves the development of a trigger generator that employs inductive storage and an opening switch. This triggering mechanism offers several advantages compared to Marx generators, particularly in terms of the ability to attain greater peak power and shorter pulse duration.

REFERENCES

- [1] I. V. Grekhov and A. F. Kardo-Sysoev, "Subnanosecond current drops in delayed breakdown of silicon pn junctions," *Sov. Tech. Phys. Lett.*, vol. 5, no. 8, pp. 395–396, 1979.
- [2] A. I. Gusev, S. K. Lyubutin, S. N. Rukin, and S. N. Tsyranov, "Superfast thyristor-based switches operating in impact-ionization wave mode," *IEEE Transactions on Plasma Science*, vol. 44, no. 10, pp. 1888–1893, 2016.
- [3] I. V. Grekhov, S. V. Korotkov, and P. B. Rodin, "Novel closing switches based on propagation of fast ionization fronts in semiconductors," *IEEE Transactions on Plasma Science*, vol. 36, no. 2, pp. 378–382, 2008.
- [4] R. D. McBride, W. A. Stygar, M. E. Cuneo, D. B. Sinars, M. G. Mazarakis, J. J. Leckbee, and *et al.*, "A primer on pulsed power and linear transformer drivers for high energy density physics applications," *IEEE Transactions on Plasma Science*, vol. 46, no. 11, pp. 3928–3967, 2018.
- [5] J. D. Sethian, D. G. Colombant, J. L. Giuliani, R. H. Lehmborg, M. C. Myers, S. P. Obenshain, and *et al.*, "The science and technologies for fusion energy with lasers and direct-drive targets," *IEEE Transactions on Plasma Science*, vol. 38, no. 4, pp. 690–703, 2010.
- [6] R. R. Childers, E. E. Petkov, V. L. Kantsyrev, A. S. Safronova, A. Stafford, V. V. Shlyaptseva, I. K. Shrestha, K. A. Schultz, and C. J. Butcher, "X-ray line polarization of ne-like mo spectra from x-pinch plasmas," *IEEE Transactions on Plasma Science*, vol. 46, no. 11, pp. 3820–3828, 2018.
- [7] R. Zhang, H. Luo, X. Zou, H. Shi, X. Zhu, S. Zhao, X. Wang, S. Yap, and C. S. Wong, "Energy spectrum measurement of x-ray radiation from a compact x-pinch device," *IEEE Transactions on Plasma Science*, vol. 42, no. 10, pp. 3143–3147, 2014.
- [8] Y. Bacqueyrisses, T. Reess, A. S. de Ferron, V. Tchalla, and B. M. Novac, "Phenomenological studies for optimizing subsonic underwater discharges," *IEEE Transactions on Plasma Science*, vol. 49, no. 11, pp. 3615–3624, 2021.
- [9] S. Ishii, K. Yasuoka, and S. Ibuka, "Pulsed power application assisted by power semiconductor devices," in *Proceedings of the 13th International Symposium on Power Semiconductor Devices ICs. IPSD '01 (IEEE Cat. No.01CH37216)*, 2001, pp. 11–14.
- [10] I. V. G. A. V. Gorbatyuk and A. V. Nalivkin, "Theory of quasi-diode operation of reversely switched dynistors," *Solid. State. Electron.*, vol. 31, no. 10, p. 1483–1491, Oct. 1988.
- [11] S. V. Korotkov, "Switching possibilities of reverse switched-on dynistors and principles of rsd circuitry (review)," *Instruments Exp. Tech.*, vol. 45, no. 4, p. 437–470, 2002.
- [12] S. Schneider and T. Podlesak, "Reverse switching dynistor pulsers," *IEEE Transactions on Plasma Science*, vol. 28, no. 5, pp. 1520–1523, 2000.
- [13] H. Wang, X. He, W. Chen, B. Xue, and A. Qiu, "A high-current high-di/dt pulse generator based on reverse switching dynistors," *IEEE Transactions on Plasma Science*, vol. 37, no. 2, pp. 356–358, 2009.
- [14] X. He, H. Wang, B. Xue, W. Chen, J. Zhou, and J. Tang, "A 12-kv high-voltage semiconductor switch based on 76-mm reverse-switching dynistors," *IEEE Transactions on Plasma Science*, vol. 39, no. 1, pp. 285–287, 2011.
- [15] S. Korotkov, Y. Aristov, A. Zhmodikov, A. Kozlov, and D. Korotkov, "High-power switches based on reversely switched-on dynistors for high-voltage pulse technologies," *Instruments and Experimental Techniques*, vol. 57, pp. 291–295, 05 2014.

- [16] A. G. Arzev, I. V. Galakhov, L. S. Ganin, A. V. Grishanin, V. V. Eliseev, V. N. Kartaev, and *et al.*, "Current pulse switches on the basis of reverse switch-on dynistors for power electrophysical equipment," *Instruments and Experimental Techniques*, vol. 64, p. 529–538, 2021.
- [17] A. Gusev, S. Lyubutin, V. Patrakov, S. Rukin, B. Slovikovsky, M. Barnes, T. Kramer, and V. Senaj, "Fast high-power thyristors triggered in impact-ionization wave mode," *Journal of Instrumentation*, vol. 14, no. 10, pp. 10 006–10 006, 2019.
- [18] A. Gusev, S. Lyubutin, A. Ponomarev, S. Rukin, B. Slovikovsky, and S. Tsyranov, "High current and current rise rate thyristor based switches," in *2017 IEEE 21st International Conference on Pulsed Power (PPC)*, 2017, pp. 1–5.
- [19] S. Korotkov, Y. Aristov, A. Zhmodikov, and D. Korotkov, "High-voltage closing switches with nanosecond switching time based on shock ionization dynistors connected in series," *IEEE Transactions on Plasma Science*, vol. 51, no. 5, pp. 1320–1324, 2023.
- [20] S. Rukin, "Pulsed power technology based on semiconductor opening switches: A review," *Review of scientific instruments*, vol. 91, no. 1, 2020.
- [21] I. Lavrinovich, A. I. Gusev, S. Bland, A. S. de Ferron, L. Pécastaing, S. Parker, J. Yan, and B. M. Novac, "2-kv thyristor triggered in impact-ionization wave mode by a solid-state spiral generator," *IEEE Transactions on Plasma Science*, vol. 50, no. 10, pp. 3443–3451, 2022.
- [22] J. Yan, S. Parker, and S. Bland, "An investigation into high-voltage spiral generators utilizing thyristor input switches," *IEEE Transactions on Power Electronics*, vol. 36, no. 9, pp. 10 005–10 019, 2021.
- [23] A. del Barrio Montañés, V. Senaj, T. Kramer, Y. Duthel, and M. Sack, "Ultra-fast generator for impact ionization triggering," in *Journal of Physics: Conference Series*, vol. 2420, no. 1. IOP Publishing, 2023.
- [24] M. R. Degnon, A. I. Gusev, A. S. de Ferron, L. Pécastaing, G. Daulhac, A. Baranov, S. Boisne, and B. M. Novac, "Off-the-shelf diodes as high-voltage opening switches," *IEEE Transactions on Plasma Science*, vol. 50, no. 10, pp. 3384–3392, 2022.
- [25] E. Shahriari, T. Maysonnave, A. I. Gusev, A. S. de Ferron, L. Pécastaing, and B. M. Novac, "Impact-ionization switching of high-voltage thyristors connected in parallel," *IEEE Transactions on Plasma Science*, vol. 51, no. 10, pp. 2878–2884, 2023.
- [26] E. Shahriari, T. Maysonnave, A. I. Gusev, A. S. de Ferron, and L. Pécastaing, "A study of a 5.2-kv/100-mm thyristor triggered in impact-ionization mode toward fast high-current applications," *IEEE Transactions on Plasma Science*, vol. 50, no. 10, pp. 3452–3458, 2022.
- [27] J. Lehr and P. Ron, *Foundations of Pulsed Power Technology*. Hoboken, NJ, USA: Wiley, 2018.
- [28] V. S. Belkin and G. I. Shulzchenko, "Generators of powerful nanosecond and picosecond pulses based on a semiconductor element base," *Novosibirsk, Russia: Institute for Nuclear Physics*, 1991.
- [29] M. R. Degnon, A. I. Gusev, A. S. de Ferron, L. Pécastaing, A. Baranov, C. Mielot, S. Boisne, M. J. Barnes, V. Senaj, T. Kramer, and B. M. Novac, "A saturable pulse transformer based on nanocrystalline magnetic cores for an adjustable nanosecond high-voltage generator," *IEEE Transactions on Plasma Science*, vol. 51, no. 10, pp. 2849–2857, 2023.



Ejlal Shahriari (Graduate Student Member, IEEE) was born in Nowdesheh, Kurdistan, Iran. He received the M.Sc. degree in power system engineering from the K.N. Toosi University of Technology, Tehran, Iran, in 2014, and the master's degree in electrical engineering for sustainable development (E2SD) from Université de Lille, Lille, France, in 2019.

From 2020 to 2021, he worked on modular multilevel converter (MMC)-based HVDC control systems at EnergyVille Genk, Belgium. He is currently working toward the Ph.D. degree in high power thyristors triggered in impact-ionization wave mode with the Laboratoire des Sciences de l'Ingénieur Appliquées à la Mécanique et au Génie Électrique (SIAME Laboratory). His research interests include high voltage pulsed power systems, picosecond impact-ionization switching of high voltage thyristors, and HVDC power systems control.

Mr. Shahriari was a recipient of the IEEE Nuclear and Plasma Sciences Society (NPSS) Outstanding Student Paper Award at the IEEE Pulsed Power and Plasma Science Conference in 2023.



and pulse-forming lines.

Thomas Maysonnave was born in Orthez, France, in 1985. He received the Ph.D. degree in electrical engineering from the Université de Pau et des Pays de l'Adour (UPPA), Pau, France, in 2013. He was Researcher with the International Technologies for High Pulsed Power (ITHPP), Thégua, France, from 2010 to 2020. He is currently a PostDoc with the Laboratoire des Sciences de l'Ingénieur Appliquées à la Mécanique et au Génie Électrique (SIAME Laboratory). His current research interests include high-pulsed power generation, including Marx generators



Anton I. Gusev (Member, IEEE) was born in Miass, Russia, in 1988. He received the M.S. degree in electrophysics from Ural Federal University (UrFU), Yekaterinburg, Russia, in 2012, and the Ph.D. degree in engineering sciences from the Institute of Electrophysics, Ural Branch of the Russian Academy of Sciences (IEP), Yekaterinburg, in 2019.

From 2008 to 2019, he was with IEP as an Intern, a Ph.D. Student, and a Junior Researcher with the Pulsed Power Laboratory. At the same time, from 2014 to 2019, he was with UrFU as a Senior Teacher.

In 2019, he became a Post-Doctoral Researcher with the Université de Pau et des Pays de l'Adour (UPPA), Pau, France, where he has been an Assistant Professor with the Laboratoire des Sciences de l'Ingénieur Appliquées à la Mécanique et au Génie Électrique (SIAME Laboratory) since 2020. His research interests include semiconductor physics, high-power semiconductor switches, and high-voltage solid-state generators, which provide nano- and subnanosecond pulses.

Dr. Gusev is a member of the International Society on Pulsed Power Applications (ISP) and the Association for the Advancement of Pulsed Power (A2P2). He has been awarded the Young Researcher at major international pulsed power conferences (the Energy Fluxes and Radiation Effects (EFRE) 2016, the Euro-Asian Pulsed Power Conference (EAPPC) 2018, and the Gas Discharge Plasmas and Their Applications (GDP) 2021), including two supported by IEEE Pulsed Power Conference (PPC) 2017 and the IEEE International Power Modulator and High Voltage Conference (IPMHVC) 2018.



Antoine Silvestre de Ferron was born in Tarbes, France, in 1977. He received the master degree in electrical and electronic engineering from the University of Toulouse, Toulouse, France, and the Ph.D. degree in electrical engineering from the University of Pau, Pau, France, in 2002 and 2006, respectively.

From 2006 to 2008, he was a Researcher with the Atomic Energy Commission (CEA), a French government-funded technological research organization in Le Barp, France. He is currently an engineer at the head of the High Voltage Processes Teams in the SIAME laboratory of the University of Pau, France. His research interests include high-pulsed power generation, with military and civil applications. He is specialized in Marx generator and pulse forming lines in high voltage generation, in high voltage transient probes associated and in high current discharges in liquids.



Laurent Pecastaing (Senior Member, IEEE) received the Ph.D. and Research Directorship Habilitation degrees in electrical engineering from the Université de Pau et des Pays de l'Adour (UPPA), Pau, France, in 2001 and 2010, respectively. He is currently a Full Professor in pulsed power with University of Pau. He is the director of the SIAME laboratory and he is also the Director of a Common Laboratory between UPPA and CEA, France.

His current research interests include high-power microwave sources, compact pulsed power systems, and ultrafast transient probes. Dr. Pecastaing was the chairperson of the Euro-Asian Pulsed Power Conference/High-Power Particle Beams/Megagauss Magnetic Field Generation and Related Topics (EAPPC/BEAMS/MEGAGAUSS) Conference, France, in 2021. He is also a member of the International Steering Committees for both the BEAMS Conferences and the Euro-Asian Pulsed Power Conferences.