



HAL
open science

A high-power electromagnetic source for disabling improvised explosive devices

Laurent Ariztia, Njomza Ibrahim, Alexey Zhabin, Antoine Silvestre de Ferron, Marc Rivaletto, Edson Martinod, Valérie Bertrand-Vincent, Bucur Mircea Novac, Laurent Pécastaing

► **To cite this version:**

Laurent Ariztia, Njomza Ibrahim, Alexey Zhabin, Antoine Silvestre de Ferron, Marc Rivaletto, et al.. A high-power electromagnetic source for disabling improvised explosive devices. *High Voltage*, 2024, 9 (2), pp.403-409. 10.1049/hve2.12416 . hal-04521110

HAL Id: hal-04521110

<https://univ-pau.hal.science/hal-04521110>









Submitted on 26 Mar 2024

HAL is a multi-disciplinary open access archive for the deposit and dissemination of scientific research documents, whether they are published or not. The documents may come from teaching and research institutions in France or abroad, or from public or private research centers.

L'archive ouverte pluridisciplinaire **HAL**, est destinée au dépôt et à la diffusion de documents scientifiques de niveau recherche, publiés ou non, émanant des établissements d'enseignement et de recherche français ou étrangers, des laboratoires publics ou privés.

ORIGINAL RESEARCH

A high-power electromagnetic source for disabling improvised explosive devices

Laurent Ariztia¹  | Njomza Ibrahim¹  | Alexey Zhabin¹  |
 Antoine Silvestre de Ferron¹  | Marc Rivaletto¹  | Edson Martinod²  |
 Valérie Bertrand³ | Bucur Novac^{1,4}  | Laurent Pécastaing¹ 

¹Université de Pau et des Pays de l'Adour, E2S UPPA, SIAME, Pau, France

²XLIM, UMR CNRS Brive, Limoges, France

³CISTEME, Limoges, France

⁴Wolfson School of Mechanical, Electrical and Manufacturing Engineering, Loughborough University, Loughborough, Leicestershire, UK

Correspondence

Laurent Ariztia.

Email: laurent.pecastaing@univ-pau.fr

Associate Editor: Jiangtao Li

Funding information

E2S UPPA supported by the “Investissements d’Avenir”, a French programme sponsored by ANR, Grant/Award Number: ANR-16-IDEX-0002; ANR “ESCAPADE”, Grant/Award Number: ANR-18-ASTR-0019

Abstract

Ultra-wideband (UWB) microwave sources driven by specialised pulsed power generators have experienced a considerable development in the last decade due to their wide domain of new applications such as defence or counter-terrorism activity. The authors present the main findings of a research dedicated to the development of a pulsed power-driven electromagnetic field source for disabling improvised explosive devices (IED). The pulsed power generator driving the source is a 13-stage compact Marx producing voltage pulses reaching an amplitude of 0.5 MV, with a pulse repetition frequency (PRF) of up to 100 Hz. The generator is coupled to a bipolar pulse forming line, providing bipolar pulses with a dV/dt of around 1.6 MV/ns. This pulsed power system feeds an array composed of 16 Koshelev-type UWB antennas through an impedance matching transformer. The resulting electromagnetic source is capable to produce pulsed electric fields (PEFs) having a figure-of-merit (FOM) of 1 MV. First, practical experiments were carried out to study the effects of the PEFs on targets. The targets used in the present study are M2B type flashbulbs, known to have the same susceptibility as the US army M6 detonator. Different configurations of wires (shielded, twisted, etc) with different lengths were used in connecting items inside these targets. The tests were performed by placing the flashbulbs at different distances to determine the essential parameters (i.e., amplitude, duration, and frequency range) of the PEFs required to trigger them. An overview of the experimental campaign and the main findings are also presented followed by conclusions.

1 | INTRODUCTION

IMPROVISED explosive devices (IEDs) represent unconventional bombs that cause thousands of casualties each year in different parts of the world [1]. Due to the simplicity of their design and accessibility of the components, these devices become the weapon of choice for the world's terrorists, insurgents, militias, guerillas, revolutionaries, and marginal or failed states [2]. The technology for counteracting IEDs constitutes a big challenge, due to the peculiar characteristics of these devices, namely their low metallic content, high variety, and random nature of their components [1]. The triggering system of an IED remains the focus of practically all

countermeasures, since it is the only component that can be attacked with technologies. The activation mechanism of electrical IEDs is based on feeding a hot-wire-based electro-explosive device (EED) [3] with an electrical current to increase the temperature of its bridge wire. Normally, these devices are straightforward activated with DC currents or a capacitor discharge. However, currents induced by external radio frequency interference (RFI) can also produce enough dissipation power for activation. There are many studies on the possibilities of accidental activation of EEDs by RFI due to the rather large electromagnetic (EM) susceptibility of this kind of circuit [3–9]. Other research, on the contrary, proposes to use a strong electromagnetic pulse to damage the

This is an open access article under the terms of the [Creative Commons Attribution-NonCommercial-NoDerivs](https://creativecommons.org/licenses/by-nc-nd/4.0/) License, which permits use and distribution in any medium, provided the original work is properly cited, the use is non-commercial and no modifications or adaptations are made.

© 2024 The Authors. *High Voltage* published by John Wiley & Sons Ltd on behalf of The Institution of Engineering and Technology and China Electric Power Research Institute.

integrated circuits that triggers an IED [2]. The trigger might go to an open state with no explosion or it might go to a fail-closed state detonating the IED. An example of using a high-power electromagnetic pulse to electrically neutralise IEDs is detailed in Ref. [1].

The present study is devoted to the safe and remote activation of the IEDs for their neutralisation using a high-power EM field. Even today, despite the substantial immunity to RFI susceptibility of modern EED initiation mechanisms [2], remote activation can be achieved when an electromagnetic field induces a current with sufficient energy in the EED bridge wire.

The paper is organised as follows. In Section 2, features of the remote neutralisation method are discussed. The pulsed power system for generating and radiating a powerful electric field has been developed for the experimental validation of the proposed method. A detailed description of both the generator and the antenna array is presented in Section 3. It was shown in Ref. [10] that the activation energy of a military M6 detonator has the same order of magnitude (4 and 5 mJ) as the energy necessary to light an M2 flash bulb manufactured by General Electric (from 2 to 3 mJ). Therefore, a systematic test procedure for the assessment of M6 detonator activation using data from experiments in which M2 flashbulbs are remotely lighted using PEFs is proposed. This procedure and the results of numerical simulation and experimental tests are described in Section 4. Finally, conclusions are presented in Section 5.

2 | IED NEUTRALISATION METHOD

A typical design of an IED is presented in Figure 1a [5]. It consists of several components: a power supply, a triggering system, a detonator, a main charge, and a container. They may be surrounded or packed with additional materials such as nails, pieces of glass, and metal fragments to maximise their hazard during the explosion. EEDs are components widely used for the ignition or detonation of IEDs. One of the most common types of EED is the bridge wire detonator (see Figure 1b), which is composed of a pair of feeding wires that connect a very thin bridge wire located

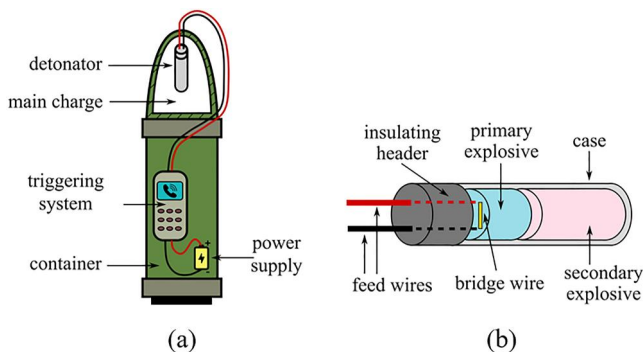

FIGURE 1 Main components of (a) an IED and (b) its detonator.

inside a cylindrical metallic case together with the triggering circuit and the power supply. The bridge wire is typically made of gold, platinum, nichrome, or aluminum with a diameter of about 25 μm , a length between 1 and 3 mm, and a resistance of about 1 Ω . The direct current delivered by a small battery is sufficient to heat the bridge wire to several hundred degrees. The bridge wire is surrounded by a primary explosive that is activated when its temperature reaches a critical value. The primary explosives represent a pyrotechnic mixture of lead acid whose auto-ignition temperature is 350°C [11]. The primary explosive once initiated sets off the secondary explosive, which in turn ignites the main charge of the IED.

A remote detonation can be achieved when an external EM field induces in the bridge wire circuit a current with sufficient energy. Indeed, power cables can act as receiving antennas to allow the EM radiated energy to couple to the EED circuit. A characterisation of the IED's EM behavior is necessary to describe the appropriate EM properties for remote activation. RF energy may reach the EED's bridge wire circuit through various coupling channels. The received power is determined by the geometry, dimensions, and materials of the weapon. Real circuits of an IED are made from a collection of wires with arbitrary geometries and, as a consequence, have an arbitrary frequency response. Hence, for an efficient coupling in order to ensure a reliable activation of the EED, a UWB signal needs to be generated. The transfer function between the electric field E of a plane wave excitation and the current induced I_{wire} in the bridge wire has been studied in Ref. [5]. It was shown that for 500 random arrangements of IED wires 20 cm in length, there are local maxima that correspond to the frequencies for which the energy absorption is the highest. The overall maximum, which corresponds to the best energy coupling, is obtained at 535 MHz, with the other two coupling frequencies being 900 MHz and 1.8 GHz. Thus, the signal produced by the driving generator and radiated by the UWB antenna should have a spectral bandwidth between 200 MHz and 2 GHz. In Ref. [10], it was shown that an impulse signal with an energy density of a few Joules per square meter, a duration of 1 ns, and a bandwidth between 200 MHz and 1 GHz is sufficient to detonate a wide variety of IEDs. The objective of the present study is therefore to see if it is possible to trigger a M2 flash bulb with a nanosecond duration UWB waveform.

3 | DESIGN OF THE SYSTEM

The block diagram of the system for activating IEDs is shown in Figure 2 and consists of two main parts, the pulsed power source generating high-power ultrashort pulses and the UWB antenna array. The pulsed power source consists of an HV charger, a Marx generator, a bipolar pulse forming line, and a matching transformer. When powered by this pulsed power source, the UWB antenna array is capable of radiating nanosecond range PEFs with a rise time of a few hundreds of

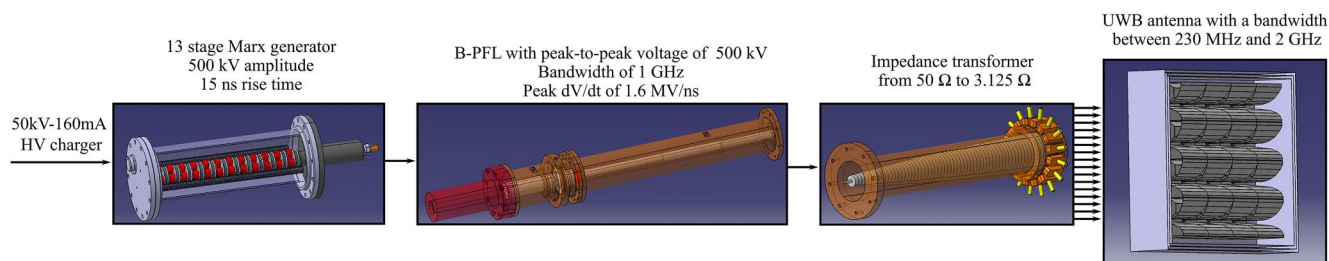

FIGURE 2 Block diagram of the complete system to activate IEDs.

ps. Details of all the components of the EM source are provided below.

3.1 | Marx generator

The Marx generator is based on spark gaps operated under pressurised air, enabling the generation of an output pulsed voltage with a peak of 0.5 MV and a rise time of 15 ns, when connected to a 300 Ω load. The aim was to develop one of the most compact 0.5 MV-class Marx generators presented in the open literature. For achieving this, it was necessary to use an innovative topology of the Marx stage arrangement. In order to function, this difficult topology required the development of a novel way of reliably triggering the spark gaps. The novel technique adopted is based on a supplementary needle-like electrode connected to the ground, generating a corona phenomenon and thus illuminating with UV the inter-electrode gap. More details on the design, manufacture, and testing of the present Marx generator were presented in Ref. [12]. Simulations using simultaneously PSpice and CST software have been performed to predict the output pulse shape and to optimise the mechanical structure of the generator [12, 13].

3.2 | Bipolar pulse forming line

The characteristics of the desired pulse shape were defined in order to optimise the antenna performance. The state-of-the-art design of the antenna highlighted the importance of a bipolar waveform input. The constraints established during the drafting of the specifications are a peak-to-peak amplitude of 500 kV, as well as an extremely fast voltage variation allowing to enrich the radiated spectrum in the high frequencies with the objective to radiate beyond 1 GHz. A Bipolar Pulse Forming Line (B-PFL) has been designed having the physical characteristics specific to its geometry. Using a bespoke numerical simulation programme, a study of the characteristic multi-parameter space was performed to evaluate precisely the influence of each part of the B-PFL unit on the shape of the output wave. Experimentally, it was then possible to adjust the voltage breakdown for both the peaking spark gap and the crowbar by changing the type and the pressure of the gas used as well as the two inter-electrode

distances. To enable a comparison with the software results, voltage measurements were made at both the input and output of the B-PFL using Vdot probes [14].

3.3 | Antenna

CISTEME has designed a very successful UWB antenna array related to the development of a medium range radiating system for an electronic warfare application [15]. This array system consists of 16 elementary antennas inspired by the work of V.I. Koshelev et al. [16]. The elementary antenna is a UWB travelling wave antenna combining a transverse electro-magnetic (TEM) horn part and a magnetic loop (Figure 3). An optimisation study was performed to reduce the overall dimensions of each elementary antenna, widen its operational frequency band, and improve its compactness [16]. The 16 antennas are positioned in a 4×4 array in contact with each other. The array is placed in front of a metallic plate, surrounded by $\frac{1}{4}$ wave corrugations of 38 cm length, allowing the reduction of the unwanted backward radiation at the lowest frequencies and harmonic frequencies and thus increasing the overall performance (Figure 4) [16]. The array is fed via a single coaxial transmission line connected to a 16-impedance transformer channel splitter allowing the operation of the 500 kV peak-to-peak pulse signal at its input. Figure 5 shows the measured gain on the axis for one antenna element and for the whole array with corrugations. The array increases the gain by about 8 dB over the entire frequency bandwidth, when compared to one single antenna element.

4 | TEST ON TARGETS

The overall system, including the Marx generator, the B-PFL, and the impedance transformer coupled to the 16 antenna arrays, was tested in an anechoic chamber. The experimental arrangement allowed performing UWB radiation tests of strong PEFs. The two objectives were as follows: firstly, to reach a figure of merit (FOM) of 1 MV (i.e., a radiated electric field of 1 MV/m at 1 m) and secondly, to analyse the effects of these electromagnetic aggressions on the M2 flashbulbs described above. As a reminder, these bulbs are used because they have the same electromagnetic susceptibility as the US

army M6 detonators. To remotely light them up is therefore, at least theoretically, the same as the detonation of the M6 unit.

The photo of the complete experimental arrangement is shown in Figure 6. It consists of the 500 kV Marx generator connected to the B-PFL through a high voltage cable. The B-PFL is connected to the impedance transformer providing

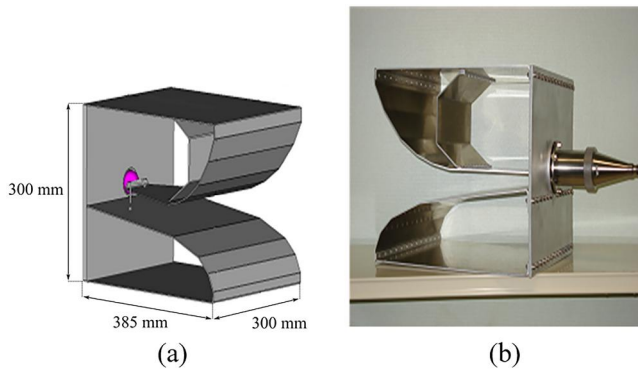

FIGURE 3 Elementary antenna 3D CST model (a) and photo (b).

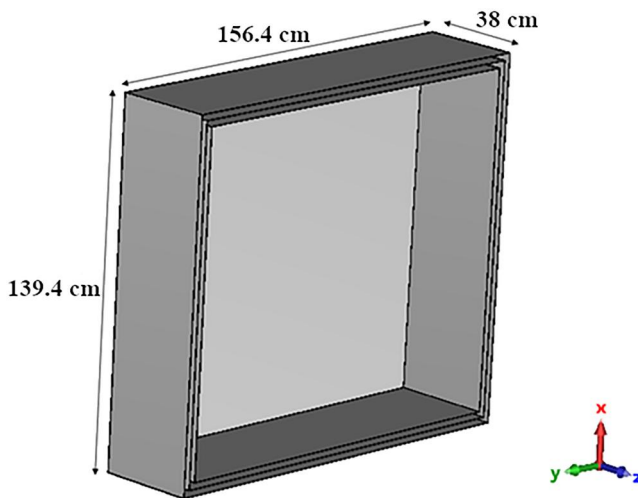

FIGURE 4 Antenna array corrugations.

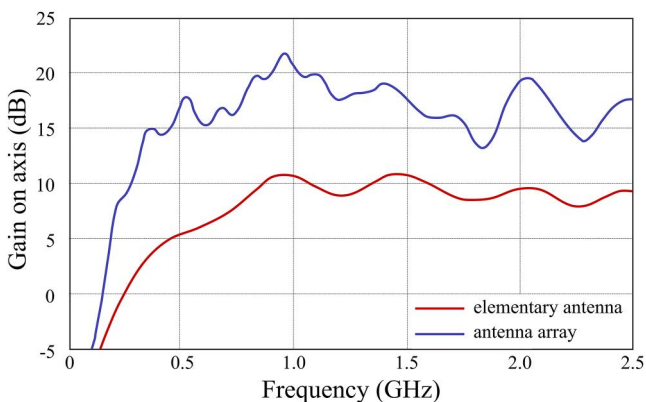

FIGURE 5 Comparison of the axial gain as a function of frequency.

the matching between the 50Ω B-PFL output transmission line and 3.125Ω at the input of the antenna array (16 antennas of 50Ω impedance each were mounted in parallel). Finally, the antenna array generates an intense PEF on its axis.

A CST simulation was performed to obtain the characteristics of the PEF distribution generated by the antenna array at various distances (Figure 7). Figure 8 shows that the time dependence of the electric field predicted by the CST model is in very good agreement with the experimental data generated by the D-dot probe. At 3 m, the CST calculation shows a well-polarised principal radial component. The time-varying surface

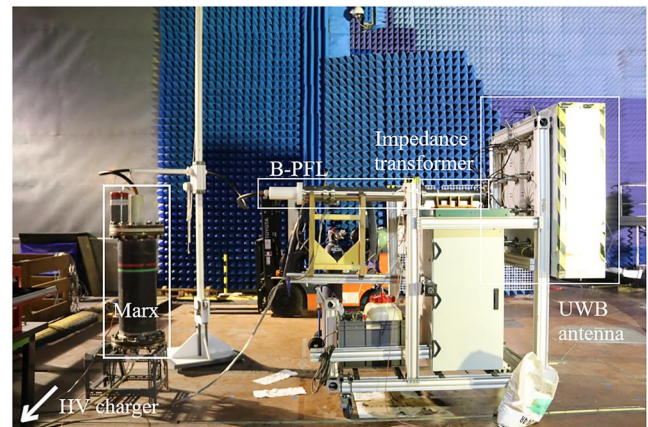

FIGURE 6 Experimental arrangement for strong PEF radiation tests in an anechoic chamber.

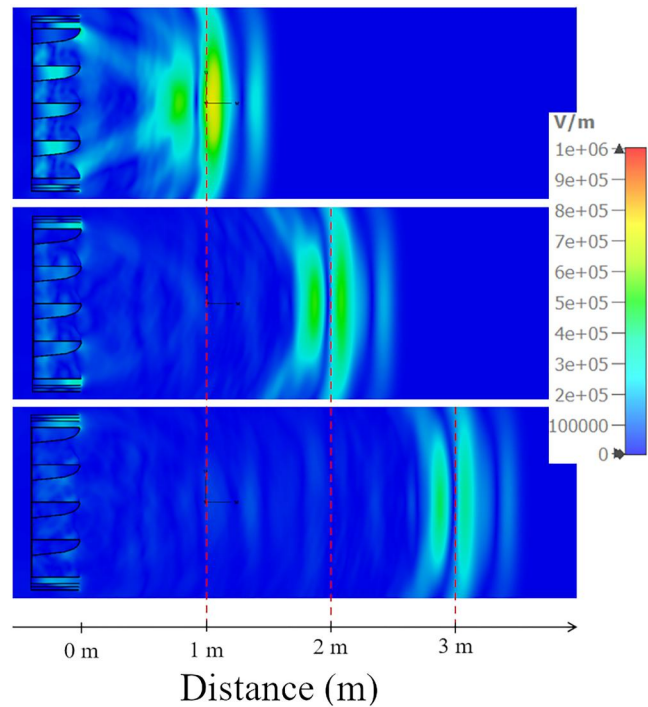

FIGURE 7 Electric field distribution during a shot. Results obtained using CST software.

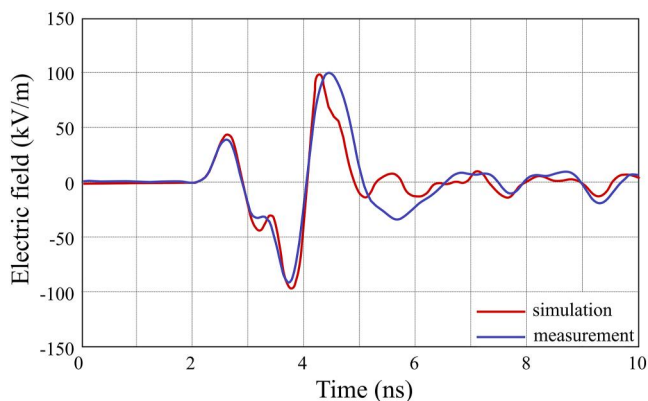

FIGURE 8 Time dependence of the electric field at 10 m from the antenna array.

density of the power associated is shown in Figure 9. The Poynting vector has been calculated using the main field components E and H . The integral is 0.2 J/m^2 . This theoretical results and the experimental ones presented just after demonstrate that even with less than 1 J/m^2 [10], one pulse can affect targets.

During the first round of tests, on-axis PEF measurements were performed at a distance of 10 m from the radiating source. Figure 10 shows that, for a voltage of 430 kV peak-to-peak generated by the B-PFL, the electric field generated on the axis, estimated for 1 m distance from the radiating source, has a value of 1 MV/m. As the amplitudes of the positive and negative electric field are almost equal, the peak-to-peak FOM of the source is close to 2 MV.

During the second part of the experimental campaign, M2 flashbulbs were placed on the axis of the antenna array.

The first aim was to demonstrate that the system was capable of depositing the required energy into a bulb to cause a flash. The flashbulbs have been tested under different configurations: connected to one or two wires of different lengths, sometimes shielded or even twisted. The target was placed at the minimum distance required for good electric field formation by the antenna array, that is, 3 m. The experimental protocol was then organised in a three-step series of shots as follows: A single pulse was first delivered by the pulse power generator. If the target was not affected that is, it did not light up, a burst of 50 electromagnetic impulses at 50 Hz PRF was then applied to the target. If this was still not enough, the target was then radiated by a burst of 250 pulses at 50 Hz PRF. The value of the peak electric field applied to the flashbulbs was set at the beginning of each series, and it remained constant during all tests. The PRF of the burst is important and has been discussed as well in the literature [5, 10]. The PRF of the electromagnetic shots reaching the target should be as high as possible, to allow the Joule deposited energy to accumulate and the temperature of the target metallic components to increase. In other words, if the PRF is not high enough, the time between shots will allow for the heat to be dissipated, thus protecting the target components from being affected.

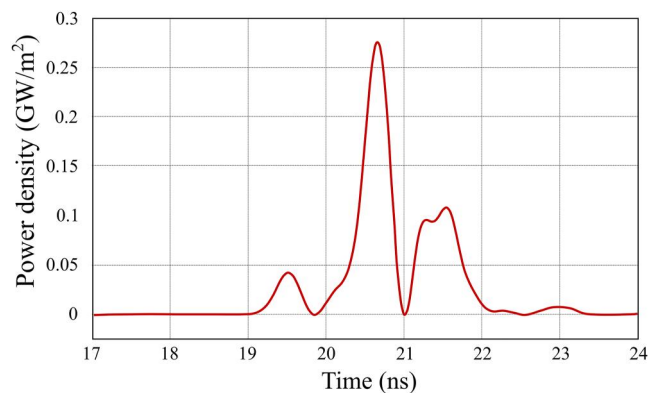

FIGURE 9 Power surface density generated by the antenna array at 3 m calculated with CST. The time origin is from the application of the voltage at the antenna input.

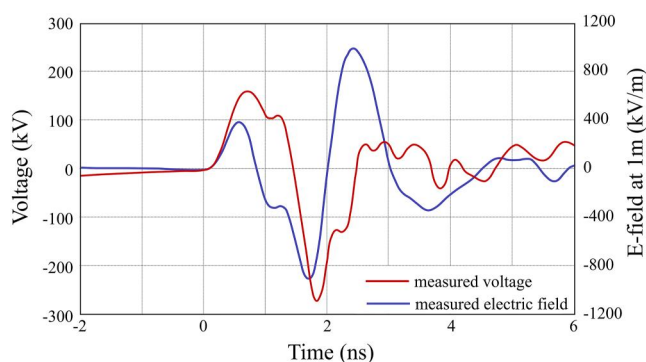

FIGURE 10 Input voltage to the antenna array and on axis PEF.

It was found that at a distance of 3.3 m and for all types of wire connected to the bulb, the bulb flashed systematically. For each of the distances tested, a D-dot field probe was placed near the bulbs to find out the PEF values required to trigger them (Figure 11).

The second aim was to find out the maximum distance at which it was possible to trigger a M2 flash bulb connected to 30 cm long untwisted and unshielded wires. The furthest distance at which the EM source was capable to trigger the flash of M2 bulbs was 8 m. At this distance, the measured electric field was 100 kV/m.

Table 1 presents the results obtained from all the successful trials, that is, those in which a flash bulb illuminates. The parameters taken into account in this study are the type and length of cable connected to the target, the average peak electric field applied to the target during a burst, the number of electric pulses applied to the target, and the distance at which the target is located with respect to the radiating source. As shown in Figure 12, three connection types were tested, labelled A, B, and C. A corresponds to an insulated wire connected to the central part of the bulb; B represents a shielded cable with the core connected to the central part of the flash bulb and the braid connected to the outer part; and C describes the configuration where two twisted insulated wires are connected to the central part of the bulb. L

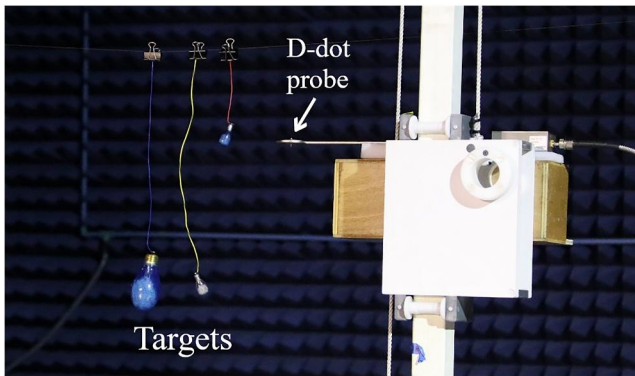

FIGURE 11 Arrangement of the flashbulbs target with the electric field D-dot probe.

TABLE 1 Configurations for which the flashbulb was affected.

Arrangement type	L (cm)	S (m)	Electric field at target ^a (kV/m)	Number of pulses applied ^b
A	30	3	221.3	50
A	10	3	221.3	50
B	30	3.3	180.2	50
C	30	3.3	172.6	50
A	10	3.3	166.3	50
A	30	3.3	162.0	1
A	10	5.6	121.8	50
A	10	3.3	113.0	250
A	10	3.3	112.2	50
A	30	8	103.2	50
A	30	8	97.9	50
A	10	5.6	96.8	50

^aAverage value of the peak electric field measured during the burst at a distance S .

^bNumber of pulses in one burst operated at a PRF of 50 Hz.

represents the length of the wire connected to the target. The distance S is the space, between the radiating source and the flash bulb (Figure 13). The average peak electric field presented in Table 1 was measured with a D-dot probe placed at this distance. The two ways to reduce the electric field applied to a target are either to increase the distance between the antenna and the flash bulb or reduce the applied voltage to the antenna.

The M2 flashbulbs were manufactured by General Electric since 1930 and are no longer available on the market. The manufacturer paid little attention to details, and therefore, two flashbulbs produced at that time were not identical. These differences can also be noticed in the electromagnetic susceptibility of this target as highlighted by the results. The present work shows a practical demonstration using ‘realistic’ mock-up IEDs. By the very definition, the IED is an ‘improvised’ item, something that is not manufactured to any

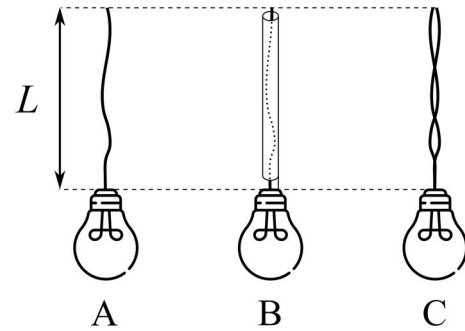

FIGURE 12 Arrangement type.

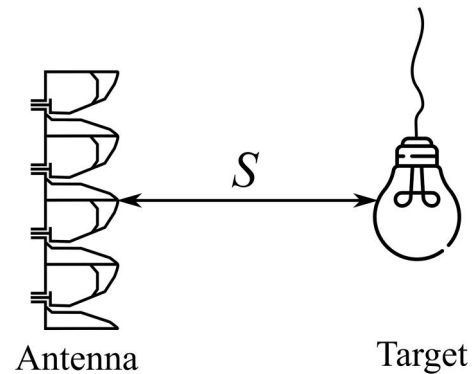

FIGURE 13 Experimental setup.

standards. The use of flash bulb target seems highly relevant, as much for its electromagnetic susceptibility close to that of an M6 detonator as for its unpredictability, which makes it similar to a real IED.

The analysis of the results of the test campaign highlights the possibility of remote triggering of an IED by a high-power EM source generating a strong PEF for a few nanoseconds. The different criteria stated in the bibliography [10] and which served as a basis for the theoretical design are thus fully confirmed.

5 | CONCLUSIONS

This paper presents the main results of a research dedicated to the development of a high-power electromagnetic pulsed source for disabling IEDs. This source allows to generate a PEF with a FOM of 1 MV, an overall duration of 3 ns, a peak-to-peak duration of 0.5 ns, and a repetition rate of 50 Hz. The experiments were carried out on flash-bulb targets connected to different wire configurations: having a length between 10 and 30 cm, twisted and untwisted, and shielded and unshielded. The experimental results demonstrate the successful triggering of all types of flash-bulb targets described above at a distance of 3.3 m. For targets connected to 30 cm long untwisted and unshielded wires, the remote activation of flashbulbs was successfully demonstrated even at 8 m distance

from the radiation source. As a possible way ahead, research is intended to be conducted for the optimisation of the high-power microwave source in order to deliver higher energy values to the target.

ACKNOWLEDGEMENTS

This research was carried out under the framework of E2S UPPA (PULPA chair) supported by the “Investissements d’Avenir”, a French programme sponsored by ANR (ANR-16-IDEX-0002). It was also supported by ANR “ESCAPADE” (ANR-18-ASTR-0019).

CONFLICT OF INTEREST STATEMENT

The authors declare no potential conflict of interests.

DATA AVAILABILITY STATEMENT

Data openly available in a public repository that issues datasets with DOIs.

ORCID

Laurent Ariztia  <https://orcid.org/0000-0003-4208-7143>

Njomza Ibrahim  <https://orcid.org/0000-0001-7147-8384>

Alexey Zhabin  <https://orcid.org/0000-0002-4950-8847>

Antoine Silvestre de Ferron  <https://orcid.org/0000-0002-2757-1925>

Marc Rivaletto  <https://orcid.org/0000-0002-9983-0295>

Edson Martinod  <https://orcid.org/0000-0003-4422-5263>

Bucur Novac  <https://orcid.org/0000-0002-5997-4016>

Laurent Pécastaing  <https://orcid.org/0000-0002-1842-7403>

REFERENCES

- Vega, F., et al.: High power electromagnetics applied to humanitarian demining in Colombia. In: 2016 USNC-URSI Radio Science Meeting, pp. 33–34. IEEE (2016)
- Zorpette, G.: Countering ieds. *IEEE Spectr.* 45(9), 26–35 (2008)
- Pantoja, J.J., et al.: Characterization, modeling, and statistical analysis of the electromagnetic response of inert improvised explosive devices. *IEEE Trans. Electromagn Compat.* 56(2), 393–403 (2013)
- Pantoja, J.J., et al.: Susceptibility of electro-explosive devices to microwave interference. *Defence Sci. J.* 63(4), 386–392 (2013)
- Pantoja, J.J., et al.: On the electromagnetic susceptibility of hot wire-based electroexplosive devices to RF sources. *IEEE Trans. Electromagn Compat.* 55(4), 754–763 (2012)
- Acosta, P., et al.: A study on the electromagnetic susceptibility of improvised explosive devices. In: European Electromagnetics International Symposium EUROEM 2012 (2012)
- Raghavaiah, V., et al.: An Analytical approach for estimation of EMC performance of Electro Explosive Device (EED) package. In: 2013 International Conference on Microwave and Photonics (ICMAP), pp. 1–6. IEEE (2013)
- Pantoja, J.J., et al.: On the differential input impedance of an electro-explosive device. *IEEE Trans. Microw. Theor. Tech.* 66(2), 858–864 (2017)
- Sonnemann, F.: Susceptibility of bridgewire EED (inert) against HPEM. In: 2007 International Conference on Electromagnetics in Advanced Applications, pp. 756–759. IEEE (2007)
- Zucker, O.S., Yu, P.K.L., Griffin, A.: Photoconductive switch-based HPM for airborne counter-IED applications. *IEEE Trans. Plasma Sci.* 42(5), 1285–1294 (2014)
- Eggert, J.: The ignition of explosives by radiation. *J. Phys. Chem.* 63(1), 11–15 (1959)
- Ariztia, L., et al.: Development and test of a 500-kV compact Marx generator operating at 100-Hz PRF. *IEEE Trans. Plasma Sci.* 50(9), 3123–3130 (2022)
- Zhabin, A., et al.: Determination of breakdown voltage along the surface of a cylindrical insulator. *IEEE Trans. Dielectr. Electr. Insul.* 29(1), 327–333 (2022)
- Ibrahimi, N., et al.: An advanced 3-D electromagnetic analysis and experimental validation of a bipolar subnanosecond pulse generation system. *IEEE Trans. Plasma Sci.* 51(3), 785–793 (2023)
- Cadilhon, B., et al.: Ultra wideband antennas for high pulsed power applications. *Ultra Wideband Commun. Novel Trends—Antennas Propagation*, 284–306 (2011)
- Koshelev, V.I., et al.: Ultrawideband radiators of high-power pulses. In: PPS-2001 Pulsed Power Plasma Science 2001. 28th IEEE International Conference on Plasma Science and 13th IEEE International Pulsed Power Conference. Digest of Papers (Cat. No. 01CH37251), pp. 1661–1664. IEEE (2001)

How to cite this article: Ariztia, L., et al.: A high-power electromagnetic source for disabling improvised explosive devices. *High Voltage.* 1–7 (2024). <https://doi.org/10.1049/hve2.12416>