



HAL
open science

Air-based hybrid photovoltaic/thermal systems: A review

Y. Chaibi, T. El Rhafiki, R. Simón-Allué, I. Guedea, S. Cardamas Luaces, O. Charro Gajate, Tarik Kousksou, Y. Zeraouli

► To cite this version:

Y. Chaibi, T. El Rhafiki, R. Simón-Allué, I. Guedea, S. Cardamas Luaces, et al.. Air-based hybrid photovoltaic/thermal systems: A review. *Journal of Cleaner Production*, 2021, 295, pp.126211. 10.1016/j.jclepro.2021.126211 . hal-04482231

HAL Id: hal-04482231

<https://univ-pau.hal.science/hal-04482231>

Submitted on 22 Jul 2024

HAL is a multi-disciplinary open access archive for the deposit and dissemination of scientific research documents, whether they are published or not. The documents may come from teaching and research institutions in France or abroad, or from public or private research centers.

L'archive ouverte pluridisciplinaire **HAL**, est destinée au dépôt et à la diffusion de documents scientifiques de niveau recherche, publiés ou non, émanant des établissements d'enseignement et de recherche français ou étrangers, des laboratoires publics ou privés.



Distributed under a Creative Commons Attribution - NonCommercial 4.0 International License

Air-based hybrid Photovoltaic/Thermal systems: A review

Y. Chaibi^(a), T. El Rhafiki^(a), R. Simón-Allué^(b), I. Guedea^(b), S. Cardamas Luaces^(c), O. Charro Gajate^(c), T. Kousksou^(a), Y. Zeraouli^(a)

^(a) Université de Pau et des Pays de l'Adour, E2S UPPA, SIAME, Pau, France.

^(b) EndeF Engineering S.L., Pol. Ciudad del Transporte, 50820 Zaragoza, Spain.

^(c) KRD Global Group

Corresponding author:

E-mail address: chaibi.yassine@gmail.com

Tel: +212618486733

Authors mail addresses:

T. Kousksou: tarik.kousksou@univ-pau.fr

Air-based hybrid Photovoltaic/Thermal systems: A review

Abstract

In recent years, a number of Photovoltaic/Thermal (PV/T) air designs were tested and investigated. However, it is challenging to assess whether a sophisticated design will be significantly more efficient than a basic one. This paper intends to outline different investigations conducted over the last years on photovoltaic-thermal technology. Findings from theoretical and experimental works, aiming to improve the efficiency of this technology regarding electrical and thermal power, are presented and discussed. Possible applications and future development of these technologies are also addressed.

Keywords: PV/T air collector; Electrical efficiency; Thermal efficiency; Performances

1. Introduction

Nowadays, the electrical conversion efficiency of most photovoltaic panels (PV) is about 12-20% (Allouhi et al., 2019; Chaibi et al., 2020; Maria and Yassine, 2020). This means that approximately 85% of the received light from the sun is either reflected or absorbed as thermal energy (Avezov et al., 2011; He et al., 2006). Consequently, this absorbed energy by the system can significantly rise the operating temperature at the junction level of PV cells. Increasing the PV module temperature will not only reduce the electricity production, but also the lifetime of the module itself (Chaibi et al., 2019b; Skoplaki and Palyvos, 2009). For this reason, a technique able to cool the PV module is highly solicited to enhance both the energy efficiency and the lifetime of the solar panels (Siecker et al., 2017). To optimize the PV modules performances, a cooling process using a cooling fluid can be implemented. The heat recovered by the cooling fluid will then be stored as thermal energy or directly used in many applications like space heating or agriculture sector; this is the fundamental principle of PV/T collectors (Abdelrazik et al., 2018).

The PV/T system is an interesting technology as it combines both the photovoltaic and the thermal entities, generating electrical energy and heat simultaneously (Rejeb et al., 2020). Most popular PV/T systems are designed with a cooling fluid flowing in an open loop (usually air) (Yang and Athienitis, 2014); or a closed loop (usually water) (Y. Yu et al., 2019), but there are also other PV/T collectors using a hybrid cooling system of air and water (Su et al., 2016). Water-based PV/T configurations are more efficient than air-based systems due to the high thermo-physical properties (He et al., 2006).

Over the last several years, a significant amount of R&D studies on PV/T technology were carried out and different review papers on PV/T configurations have been published (Abdul Hamid et al., 2014; Chow, 2010; Diwania et al., 2020; Zondag, 2008). Nevertheless, PV/T/air collectors have been more investigated during the last years due to their low manufacturing costs (Fudholi et al., 2015; Kumar et al., 2015; Vaishak and Bhale, 2019). Further, a limited number of reviews has been entirely devoted to the developments of air-based PV/T systems (Hussain et al., 2013). Therefore, this work will only focus on air-based PV/T systems.

Air cooling systems are characterized by its simple and economical behavior in cooling the photovoltaic panels. Air can be heated to various temperature ranges and its

circulation can be either forced (via a fan) or natural. Forced circulation is required due to a better heat transfer by convection and conduction, but the fan power consumption decreases the net electricity gain (Barone et al., 2019; Ibrahim et al., 2011).

The aim of this report is to propose a detailed discussion regarding the development of different designs of air-based hybrid PV/T systems. The state-of-the-art research, applications of these configurations and the possible future development of these systems will be also addressed and presented.

2. Current status and research trends of the PV/T air systems

This section reports a summary time-line of air-based PV/T collectors, outlining the relevant papers available and achievements in the field of air-based PV/T technology until the year 2020.

2.1 Theoretical and numerical studies of PV/T air systems

Most research in this field focused on evaluating the electrical, thermal and exergy performances (Agrawal and Tiwari, 2013a; Touafek et al., 2013; Yazdanifard and Ameri, 2018); or analyzing the cost-effectiveness of these technologies by estimating the solar coverage rate (Yazdanifard and Ameri, 2018; Zondag, 2008). For this purpose, the development of physical models has been crucial to study the behaviour of these systems under steady state or in dynamic conditions (Das et al., 2018; Riffat and Cuce, 2011).

As reported in various review articles on PV/T systems, Kern and Russell (Kern and Russell, 1978) are among the first researchers who outlined the basic principles of hybrid solar collectors using air as a heat transfer fluid. Younger et al. (Younger et al., 1981) investigated an PV/T air collector in where the top surface of the fluid duct is a PV sheet. On the other side, the PV sheet was incorporated with rough Teflon. Hendrie (Hendrie, 1982) presented two configurations to ameliorate heat transfer in the PV/T air plant, as shown in **Fig.1**. In the primary configuration, the fluid passes through a multi-perforated plate and then flows across the principal absorber. In the 2nd technology, the two absorbers are separated by a waved V-wall. 40% and 42% are respectively the thermal

efficiency values for the first and second configuration. 8.9% and 7.8% are the values of electrical efficiency for the first and second configuration respectively.

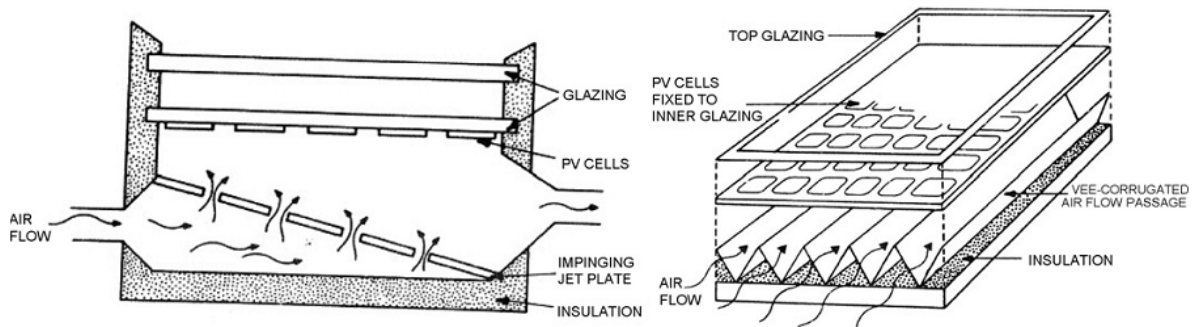

Fig.1: PV/T air systems: Left (impinging jet design), Right (V-grooved design) (Hendrie, 1982).

Cox and Raghuraman (Cox and Raghuraman, 1985) implemented simulation software to study the energy efficiency of air PV/T modules, focusing on the impact of the optical properties of the glazing on the overall efficiency of the modules. They found that the implementation of a low-emission indium-tin oxide (ITO) layer on the PV improved the thermal efficiency of the system from 34% to 39%.

Sopian et al. (Sopian et al., 1996) presented a stationary physical model to describe the thermal and electrical behavior of single-and double-pass air-based PV/T plant (see **Fig.2**). The double-pass PV/T plant exhibited a noticeably good efficiency due to the increase in the heat exchange surface between the air and the photovoltaic cells. Garg and Adhikari (Garg and Adhikari, 1997) also reported similar results for single-glass and double-glass conceptions.

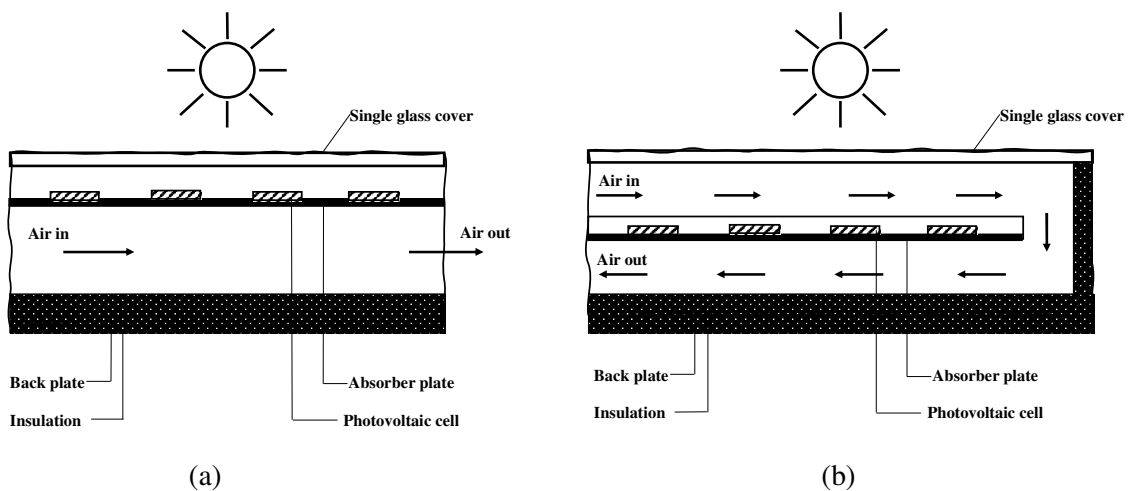

Fig.2: Hybrid PV/T air collector (a) single-pass, (b) double-pass (Sopian et al., 1996).

Brinkworth (Brinkworth, 2002) simulated the convective and radiative phenomena occurring in the air gap in the air-based PV/T system. The objective of this study is to assess the evolution of wall and air temperature profiles along the air gap in laminar and turbulent conditions. Indeed, the thermal transfers in the air gap are partly by convective transfers between the air and the two walls and partially by radiative transfer between the two walls. The author proposed a method to take into account the interaction between the two types of heat transfer and thus avoids the use of iterative methods generally adopted to estimate the radiative heat transfer. However, this model remains detailed and the knowledge of all its parameters involved is often lacking. Chow (Chow, 2003) published an explicit dynamic model to study the performances of the air PV/T system.

Vokas et al. (Vokas et al., 2006) performed a theoretical study of a PV/T hybrid fluid module (covering an area of 1.32 m^2) with a focus on its thermal performance. The thermal efficiency of this system was compared to that of a standard air thermal solar collector (1.32 m^2 surface area) and a selective absorber air thermal solar collector (2 m^2 surface area). If the air input temperature into the solar panel is equal to the ambient air temperature, the obtained results indicate that the PV/T system has a thermal efficiency of 9% lower than that of the standard thermal solar collector (whose efficiency is 70%). The solar collector with a selective absorber offers a higher thermal efficiency (approx. 75%). However, the advantage of the hybrid solar collector is that it can produce, in addition to a significant amount of thermal energy, electrical energy over an area equivalent to that of the standard solar panel and over an area smaller than that of the selective absorber of the system.

Mei et al. (Mei et al., 2006) used TRNSYS to investigate the impact of PV/T air plant on the energy building consummation during winter and summer. The obtained results have been verified by using experimental data. Joshi and Tiwari (Joshi and Tiwari, 2007) presented an energy and exergy analysis of an unglazed, Tedlar-coated air PV/T hybrid solar collector. Their results indicated that the thermal and electrical efficiency of the system are around 60% and 14.5% respectively. Tonui and Tripanagnostopoulos (Tonui and Tripanagnostopoulos, 2007a) developed a physical model of an air PV/T system using the analogy with the solar thermal collector model and experimental results. The model allows the calculation of the thermal and electrical efficiencies of the solar collector without requiring precise knowledge of its composition and without involving

thermodynamic modelling. However, this model is not applicable to all systems and experimental data are required to assess the performance of the system. Furthermore, the authors have not conduct a study on the uncertainties of their model, so the effects of collector inertia and certain phenomena such as radiation transfer are not evaluated.

A comparative analysis was conducted by Ibrahim et al. (Ibrahim et al., 2009) to study the energy performance of two hybrid collectors: a single pass rectangular tunnel absorber collector (see Fig.3) and spiral flow absorber collector. The prototype of the single-pass rectangular channel designed to produce hot air and electricity, while the spiral system flow conceived to provide hot water and electricity. The single-pass channel rectangular absorber collector has an overall efficiency of 55% with an electrical efficiency of 10% and a maximum power of 22.45W.

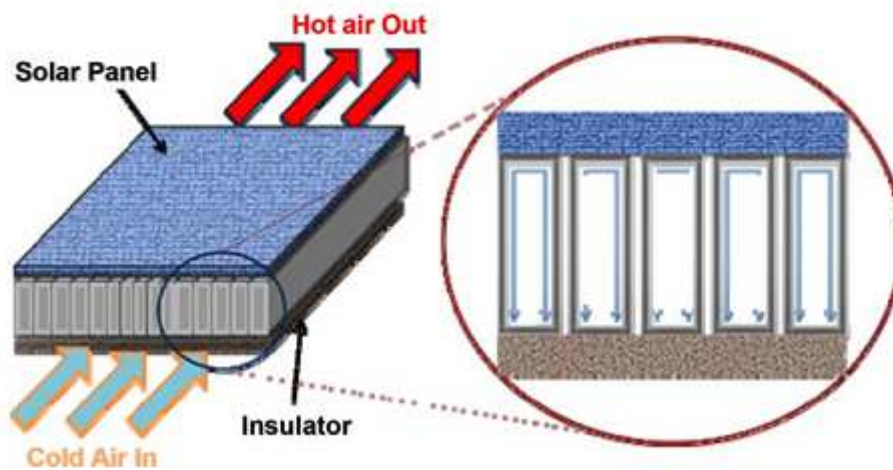

Fig.3: PV/T air collector with rectangular absorber collector design (Ibrahim et al., 2009).

Dubey et al. (Dubey et al., 2009a) have reported mathematical model to study the influence of airflow on the electrical performances of PV panels according to climatic and system parameters. Two PV/T systems with and without channel are examined in this study, which are defined as: Glass to glass and Glass to Tedlar PV system. The authors noted that glass-on-glass PV panels comprising a channel provide good electrical efficiency and higher exit air temperatures. Dubey et al. (Dubey et al., 2009b) presented an energy and exergy study of a PV/T plant by varying the number of collector's in-series and air velocity under different climatic conditions. They concluded that collectors entirely coated with PV panel and air flows underneath the absorber plate give the best performances.

Sarhaddi et al. (Sarhaddi et al., 2010a, 2010b) performed an electrical and thermal model to assess the energetic and exergetic efficiency of a PV/T air plant. Some modifications concerning heat losses coefficients have been introduced to refine the thermal model of a PV/T air collector and a detailed electrical model has been applied to ensure more accurate calculations of the electrical parameters of the PV/T air collector. Good agreement was found between the authors' numerical results and the experimental data. Shahsavar and Ameri (Shahsavar and Ameri, 2010) presented a physical model to evaluate the energy performance of a PV/T air collector, which is manufactured and tested under Kerman climate, Iran. A thin aluminium foil suspended in the middle of the air channel is inserted to improve the heat transfer surface and therefore the heat extraction from the PV panels. The PV/T air system was also tested in natural and forced convection. The authors' results indicated good agreement between the simulation and experimental data.

Candanedo et al. (Candanedo et al., 2010) reported a comparison of physical models of PV/systems in stationary and unstationary regimes with laboratory data. A good fit between the measured data and the transient model was demonstrated with respect to the stationary model.

Kamthania et al. (Kamthania et al., 2011) presented a physical model to evaluate the performance of double pass PV/T air system for space heating, under quasi-steady state conditions and for New Delhi Climate, India (see **Fig.4**). The authors noticed that the proposed configuration ameliorates considerably the overall efficiency of the system and increases the room temperature during winter days.

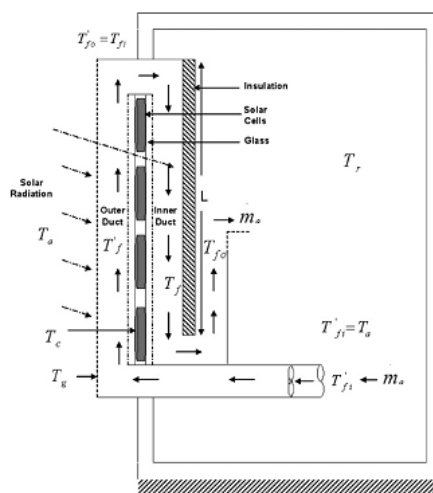

Fig.4: PV/T air system used as a façade in building for space heating (Kamthania et al., 2011).

Brideau and Collins (Brideau and Collins, 2014, 2012) performed a physical model of a PV/T collector using impinging air jets (see **Fig.5**). An experimental prototype was conceived by the authors to verify and test their model. The authors showed that impinging jets provide higher efficiencies in air based solar collectors compared to typical parallel flow designs.

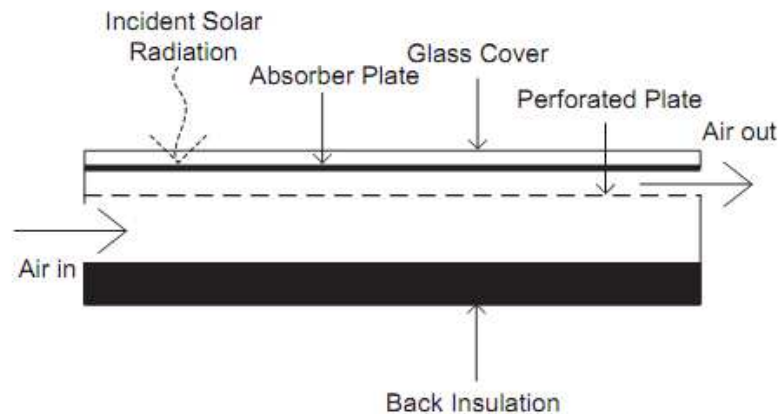

Fig.5: Impinging jet PV/T air system (Brideau and Collins, 2012).

Khelifa et al. (Khelifa et al., 2015) studied numerically the overall performance of the PV/T air module by using the ANSYS14 software. The effect of various climatic parameter like a global radiation and wind speed was discussed and presented by the authors (see **Fig.6**). The authors found that the efficiency of the module is highly dependent on the solar flux received by the system as well as to the air mass flow rate flowing through the collector.

Elsafi and Gandhidasan (Elsafi and Gandhidasan, 2015) performed a physical model to examine the influence of the fins design of the energy efficiency of a double-pass PV/T air collector. Three profiles of fins are tested and the impact of the number, dimension and the thermophysical properties of fins on the overall efficiency of the PV/T system was also discussed and presented by the authors. Simulation results demonstrated that pin fins are advantageous to achieve better performance compared to the straight fin design. Bambrook and Sproul (Bambrook and Sproul, 2016) presented a RC circuit model to evaluate the energy efficiency of the PV/T air collectors operating on a steady-state regime. According to the authors, this model can be used to rapidly and easily analyze the performance of PV/T air collectors that have a rather complex geometry.

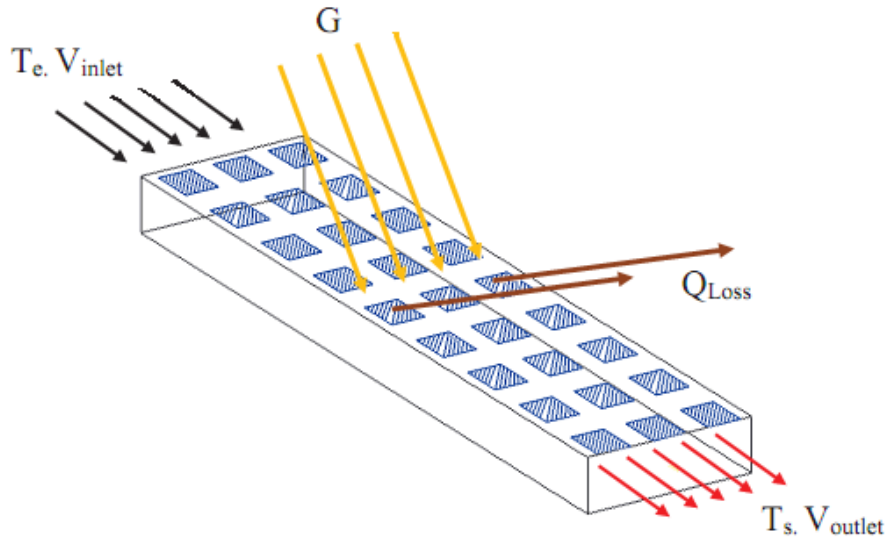

Fig.6: Schematic of the PV/T system (Khelifa et al., 2015).

Rajoria et al. (Rajoria et al., 2012) carried out theoretical analysis and optimization adopting the designs proposed by Agrawal and Tiwari (Agrawal and Tiwari, 2011a). Compared to other configurations, Case II has low heat losses, which allows it to accumulate a relatively large amount of thermal energy. The average of the electrical efficiency of Case III reached 11.3%, leading to an improvement in overall efficiency of 12.9% compared to Case II. The series assembly of several panels provides a higher air outlet temperature in Case III compared to other examined designs.

2.2 Experimental studies of PV/T air collectors

Experimental studies in controlled conditions or in situ are also necessary to validate such physical models (Shah and Srinivasan, 2018; Tiwari et al., 2018). Other research was aimed to optimize the performance of existing PV/T hybrid systems by improving the operating conditions (inclination, orientation of the component, etc.) or by proposing innovative geometrical configurations (Fan et al., 2018; Fine et al., 2019; Lin et al., 2019; Mojumder et al., 2017; Nazri et al., 2019). Thus, they were based on the modification of the dimensions or properties of the materials used (thermal insulation, absorber, PV cells, etc.) or heat transfer fluids (air, glycol water, etc.) (Brekke et al., 2018; Jia et al., 2019; Rejeb et al., 2020). These improvements aim to increase the amount of solar energy absorbed and the heat transfers between the heat transfer fluid and the absorber or to

reduce or even eliminate the external thermal losses of the hybrid solar collector (Zhang et al., 2012). Despite the higher performances achieved through the use of innovative medium, PV/T installations using air or water as an operating medium are more widely installed, particularly due to their lowest capital and maintenance costs (Nazri et al., 2019).

Posnansky et al (Posnansky and Gnos, 1994) demonstrated that the implementation of an air PV/T installation into a building can generate 12 kW of thermal energy for heating demand.

Prakash (Prakash, 1986) investigated the impact of the air mass flow, the depth of the air channel, the length and packing factor (i.e. the ratio of total area of solar cells to the area of PV module). He observed that reducing the duct depth from 3 to 1 cm improves thermal performance from 17% to 34%.

Posnansky and Eckmanns (Posnansky et al., 1998) studied and tested a PV/T air hybrid system under Switzerland environmental conditions. The thermal energy supplied by the system in the summer was saved in an underfloor tank, and in the winter it was used to heat the building. They noted that the thermal efficiency of the PV/T system varied from 32 to 45%. Previous experimental studies have shown that climatic conditions affect significantly the energy performances of the collectors (Kamthania et al., 2011).

Hegazy (Hegazy, 2000) carried out a comparison of the thermal and electrical performance of four configurations of collectors which are distinguished by the cooling mode of the PV panels, i.e. above (prototype 1), below (prototype 2), on two faces (prototype 3) of the absorber, and by a double air circulation (prototype 4) (see **Fig.7**).

The effects of air mass flow and absorbent plate selectivity on PV/T performance were analyzed and discussed. Prototype 1 showed lowest overall efficiency compared to the other prototypes. Prototype 3 exhibits better performance under strong sunlight and can easily be assembled. For low air mass flows, the use of a selective absorber is unsuitable since it considerably reduces the production of electrical energy. A double-pass PV/T hybrid air collector adapted to solar drying applications has been designed and tested by Sopian et al. (Sopian et al., 2000). The authors presented a theoretical and experimental study. Comparisons between experimental and theoretical results and a good agreement between the two results is obtained.

Aste et al. (Aste et al., 2002) performed an experimental investigation on PV/T air collector. The experiments are conducted at the Parco Lambro experimental site in Milan. The thermal and electrical efficiencies are evaluated over several days. The authors presented also the effect of air mass flow rate, collector inclination and air channel thickness. According to the results obtained by the authors, the energy efficiency of the systems is particularly sensible to the fluid velocity and the thickness the air canal.

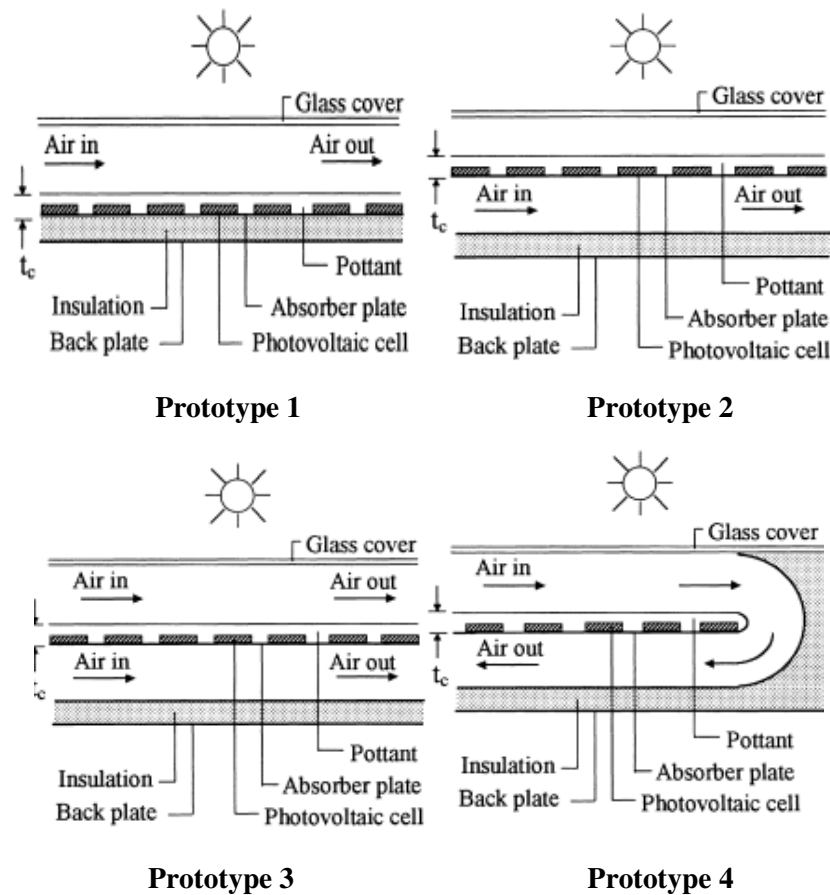

Fig.7: Schematics of the different PV/T air prototypes (Slimani et al., 2017).

Tiwari et al. (Tiwari et al., 2006) published an experimental investigation of a steady-state PV/T solar collector based on a natural or forced air-ventilated solar collector. The solar collector consists of two PV modules with a surface area of 0.61 m^2 each, connected in series and assembled on a non-corrosive Tedlar insulating layer. The PV module consists of photovoltaic cells attached together via an EVA layer and protected by a glass layer. This component was integrated into a tilting steel test system and installed in New Delhi, India. Fans located at the entrance of the air gap between the Tedlar and a wooden insulating layer allow the forced ventilation of the backside of the PV panels. The electrical energy generated is stored in an electrical battery. This study showed that the

additional recovery of the generated thermal heat improves the overall efficiency of the air PV/T plant by about 18%.

Othman et al. (Othman et al., 2005) investigated a new technology of a double-pass PV/T fluid panel with compound parabolic concentrator (CPC) and fins. In this design, the bottom surface of the absorber contains vertical fins (see **Fig.8**). It's found that the electricity production is highly dependent on the fluid velocity and the air temperature. The results obtained by Othman et al. (Othman et al., 2005) are in accordance with those reported by Garg and Adhikari (H. P. Garg and Adhikari, 1999; H.P. Garg and Adhikari, 1999) for this technology. The combination of PV/T hybrid, CPC and fins has the potential to significantly improve electricity production and reduce the cost of photovoltaic electricity.

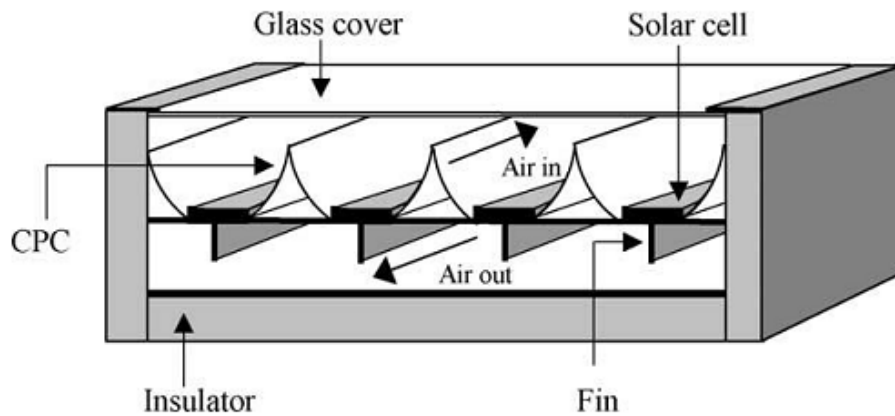

Fig.8: Double-pass PV/T air system with compound parabolic concentrator and fins (H.P. Garg and Adhikari, 1999).

Othman et al. (Othman et al., 2006) have proposed a single pass of a PV/T hybrid air collector with a V-groove form and positioned under the PV plate (see **Fig.9**). The authors showed that the integration of the v-groove inside the system improves its efficiency by 30% compared to other types of PV/T collectors.

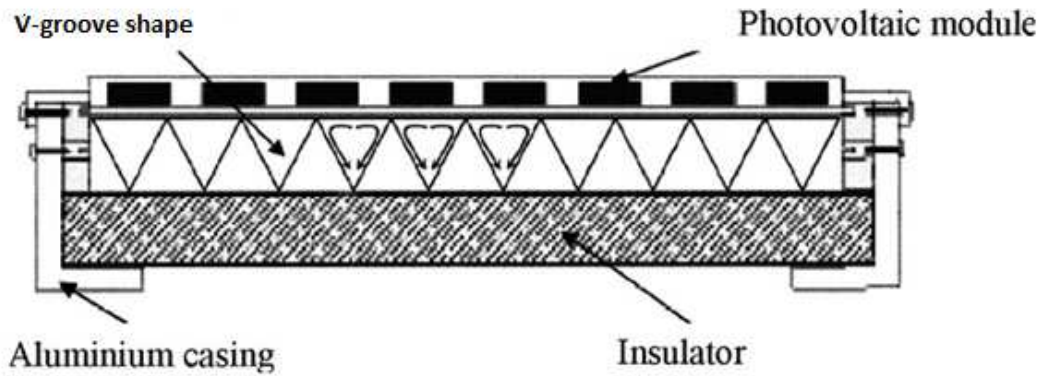

Fig.9: PV/T Hybrid Air Solar Collector with v-groove (Othman et al., 2006).

At the Indian Institute of Technology (IIT), Tiwari and Sodha (Tiwari and Sodha, 2007) conducted research on glazed and unglazed PV-T air collectors with and without Tedlar (see **Fig.10**). The obtained results showed that the glazed hybrid air collector without Tedlar is the most efficient and has a significant improvement of the overall efficiency (thermal and electrical). Unglazed PV-T air collectors with and without Tedlar provide relatively similar PV cell temperatures.

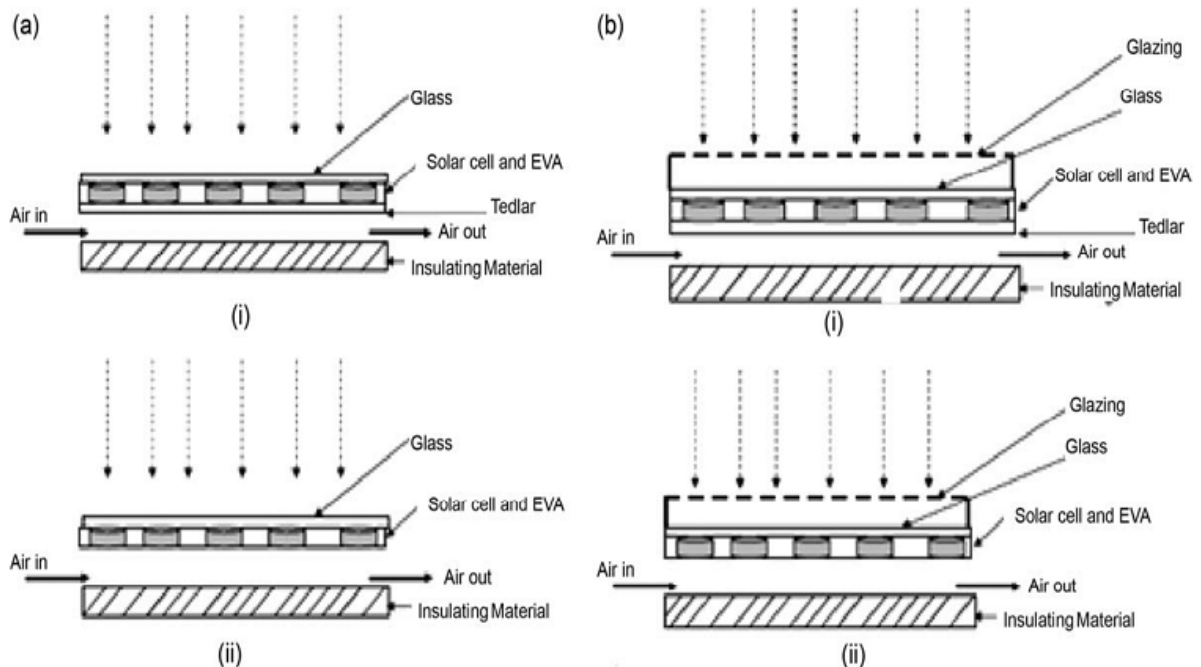

Fig.10: PV/T collector without encapsulation with and without Tedlar (Tiwari and Sodha, 2007).

Tripanagnostopoulos (Tripanagnostopoulos, 2007) conducted a numerical and experimental study on an air PV/T system to reduce the operating temperature of the PV cells, increase the production of preheated air and reduce heat loss through the underside of the PV module. They demonstrated that the use of a thin air gap improves the electrical performance of the collector but reduces the thermal efficiency of the system. To increase the thermal performance of the PV/T air collector, Tripanagnostopoulos (Tripanagnostopoulos, 2007) tested three configurations by introducing metal fins of 1.5 and 4 cm in the rear face of the collector, by adding steel ducts with a 15 cm section and by integrating a darkened steel plate at mid-height over the entire duct length (see **Fig.11**). It was remarked that the effects of the fins were relatively small compared to those of the ducts and sheet metal. Considering the associated cost and the pressure drops caused by fins and tubes, a fine metallic plate was selected to enhance the heat transfer within the PV/T module.

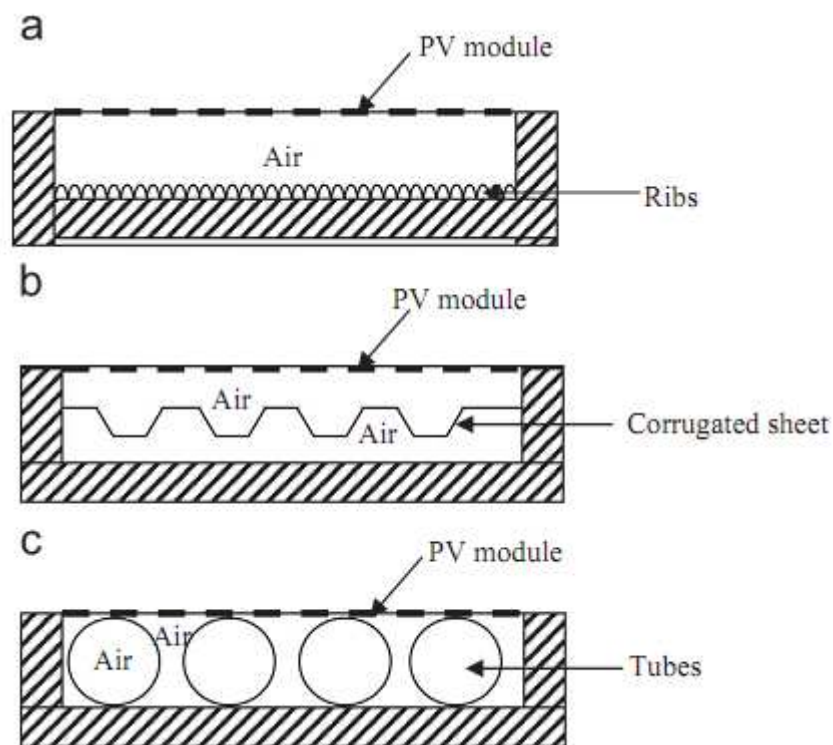

Fig.11: Examples of modifications of the PV/T air collector (Tripanagnostopoulos, 2007).

Othman et al. (Othman et al., 2007) studied a double-pass PV/T air collector in which fins are installed at the rear of the photovoltaic panel to improve the overall performances

of the plant (Alfegi et al., 2008). It has been clearly demonstrated that the introduction of the fins into the absorber improves significantly the performance of the collector.

Tonui and Tripanagnostopoulos (Tonui and Tripanagnostopoulos, 2007b) explored four configurations for an air-based PV/T system (see Fig. 12). It has been seen that both the metal plate (TMS) mounted at the center of the fluid canal and the arrangement of the fins on the opposed side of the duct improve the electrical and thermal performance of the system. The glass collector with a rear ribbed plate provides a higher heat output than the standard system. The authors also stated that fins may be more suitable for a cold climate, however, for a warm climate, thin sheet metal is more appropriate due to a reduced heat transfer to the building. The same authors studied in another paper (Tonui and Tripanagnostopoulos, 2008) three configurations of PV/T air solar collector with natural air circulation (see Fig.13). A thin metal sheet or fins are introduced in the air channel to improve heat extraction from the PV cells. The proposed systems offer better performances compared to a conventional system. The results showed that both systems (with thin metal sheet or fins) contribute positively to improving the extraction of thermal energy from PV cells with higher overall efficiency.

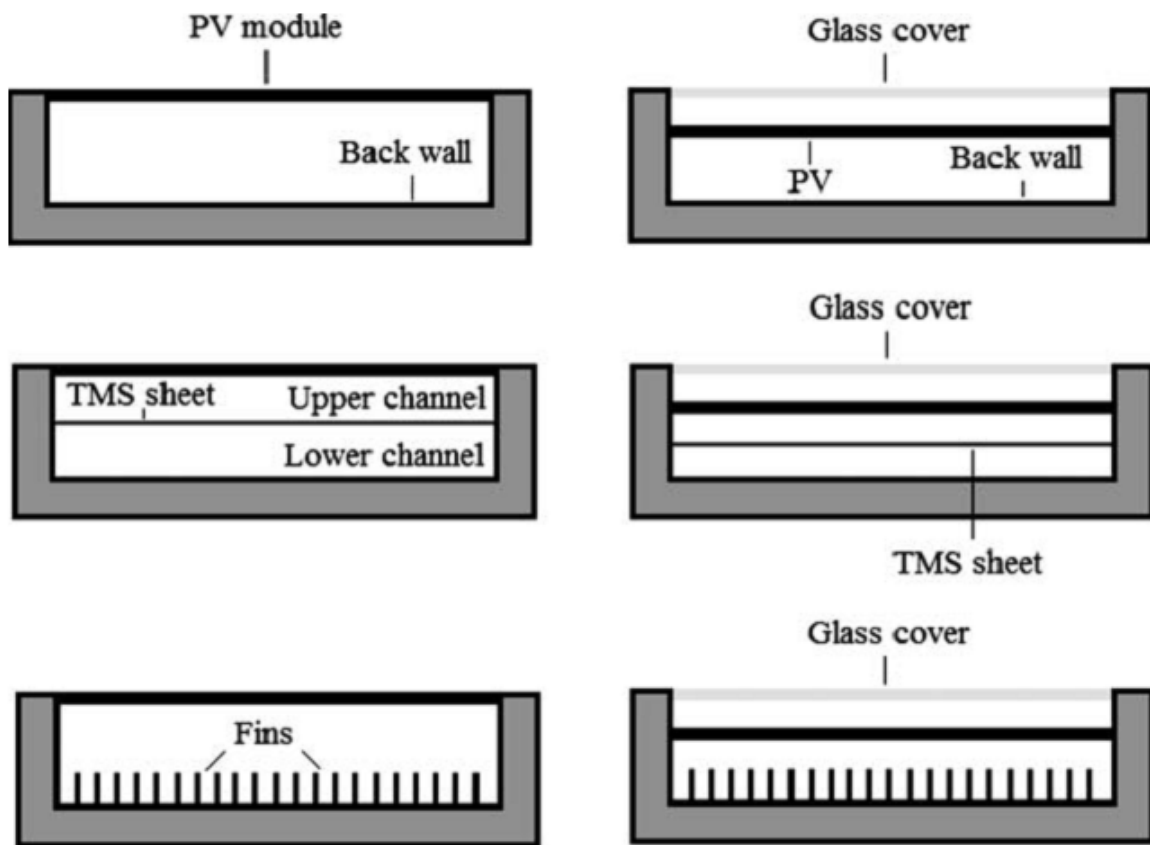

Fig.12: Various of PV/T air modules (Tonui and Tripanagnostopoulos, 2007b).

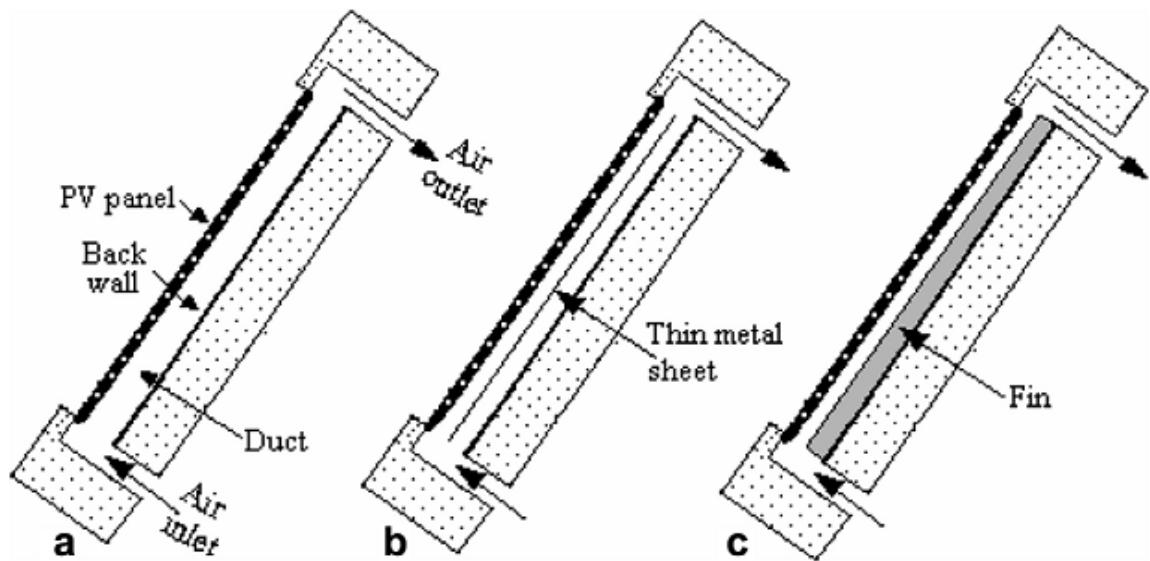

Fig.13: Hybrid air PV/T collectors: (a) conventional system (b) system with a metal sheet (c) system with fins (Tonui and Tripanagnostopoulos, 2008).

Jin et al. (Jin et al., n.d.) have conducted an experiment study on a single-pass PV/T with a rectangular absorber channel (see Fig.14). The aim of this work is to select the appropriate fluid circulation to cool the PV cells. The authors concluded that the PV/T hybrid system with a rectangular channel as a heat absorber provides higher performance than the conventional PV/T system.

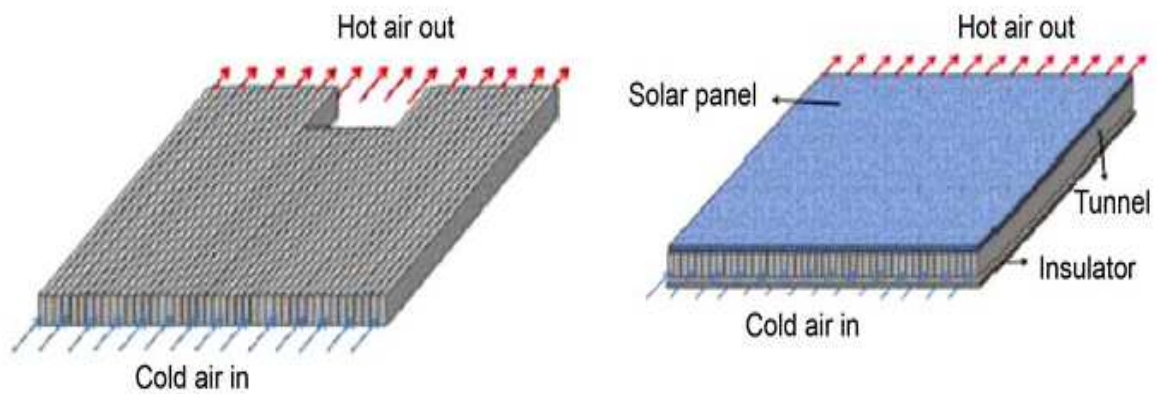

Fig.14: Single-pass PV/T with rectangular channel configuration (Jin et al., n.d.).

Agwara and Tiawri (Agrawal and Tiwari, 2011a, 2011b) studied a PV/T system installed as a building roof. The performance of this system is compared with that of a simple PV system. Although the monocrystalline BIPV/T (Building Integrated Photovoltaic Thermal) installation performs better for residential consumers regarding the overall

efficiency, the amorphous silicon plant is more cost-effective with 33.54% for thermal efficiency and 7.13% for electrical efficiency under New Delhi climate. Agrawal and Tiawri (Agrawal and Tiwari, 2013b, 2012) assessed the thermal and electrical behaviour of a BIPV/T system for four various parallel and series combinations in cold Indian weather conditions. They observed that for a constant fluid velocity, the series combination is more appropriate for buildings with rooftop. The parallel arrangement provides better performances than other configurations.

Chen et al. (Chen et al., 2010a, 2010b) studied a BIPV/T system combined with a ventilated cement slab within a passive solar home in the colder Quebec Canadian environment. The authors found that lower air velocity permits to increase considerably the fluid of around 40 °C during a sunny winter day.

Kumar and Rosen (Kumar and Rosen, 2011a, 2011b) demonstrated that the introduction of vertical fins in a double pass PV/T air improves the overall efficiency of the system. In addition, the higher the packing factor the greater the production of the electrical output per unit collector area, this will yield in controlling the cell temperature.

Agrawal and Tiwari (Agrawal and Tiwari, 2011a, 2011b) conducted an investigation to assess the overall energy and exergy performances of a microchannel PV/T system (MCPVT) for four climatic regions in India (see **Fig.15**). The comparison between the performances of MCSCT and simple PV/T collector (SCPTM) was also presented. Good performances were obtained for (SCPTM). The same authors (Agrawal and Tiwari, 2013b, 2012) conducted a socio-economic and environmental study on series-connected PV/T glazed air collectors (see **Fig.16**). The authors found that hybrid glazed PV/T air collectors are particularly beneficial for electricity generation as well as for space heating in cold climate conditions and for drying medicinal plants.

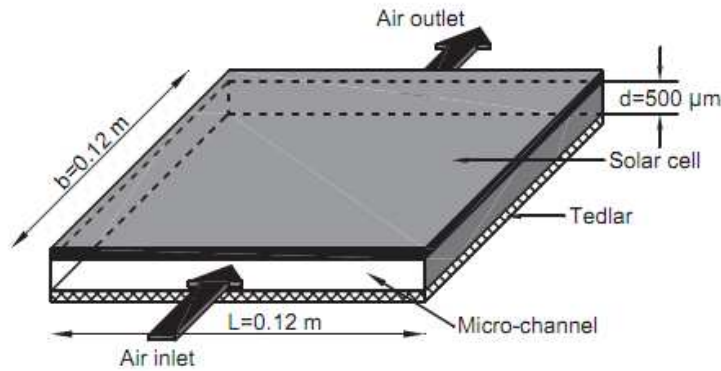

Fig. 15: The schematic of micro-channel solar cell thermal (MCST) (Agrawal and Tiwari, 2011b).

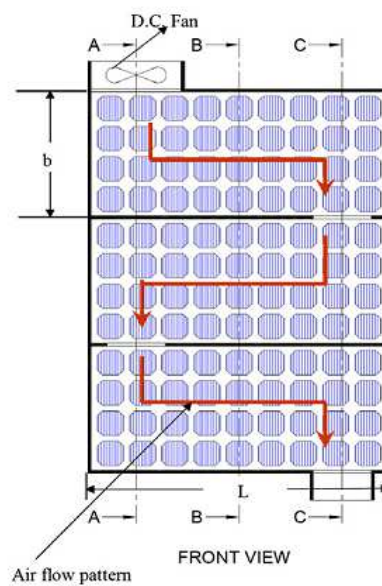

Fig. 16: Schematic of glazed hybrid PV/T module air collectors connected in series (Agrawal and Tiwari, 2012).

Teo et al. (Teo et al., 2012) designed a system with a series of air ducts to ensure uniform and homogeneous airflow distribution under the PV modules (see Fig.17). The authors demonstrated that the operating temperature of the module could be retained at 38 °C and the electrical efficiency could reach 12.5%. The mass flow rate of 0.055 kg/s is sufficient to absorb the maximum amount of heat from the PV module. When the mass flow rate exceeds this value, the thermal and electrical efficiencies are not affected.

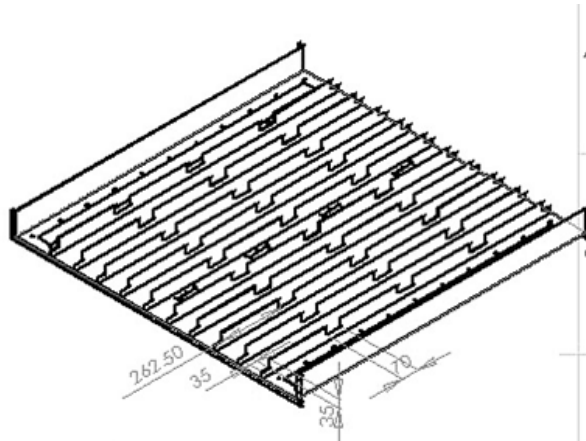

Fig.17: Sketch drawing of the air cooling system (Teo et al., 2012).

Rajoria et al. (Rajoria et al., 2015, 2013) changed the flow distribution to allow air to flow under two columns of 18 modules connected in parallel (see **Fig.18**), each with 36 PV/T tiles connected in series. The authors explored four cases and their results were matched to the third case in (Rajoria et al., 2012). Better performances have been noted with the revised versions with identical climatic environment.

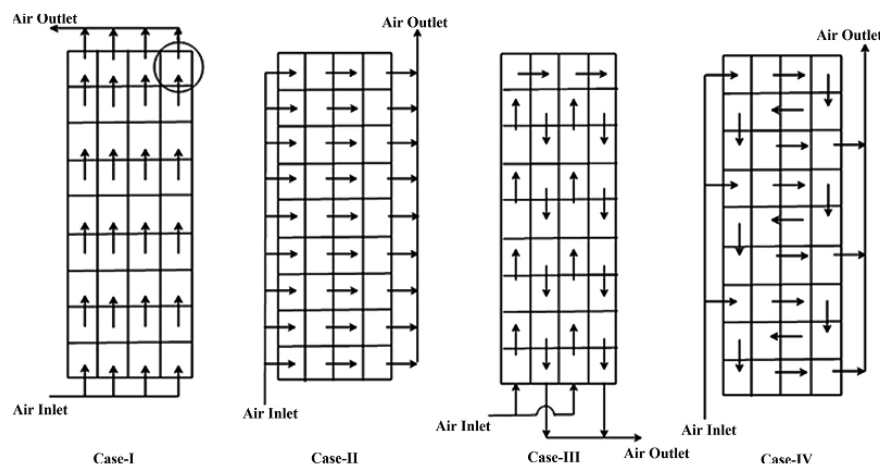

Fig.18: Series and parallel arrangement of micro-channel solar cell thermal tiles with air cooling (Rajoria et al., 2012).

Bambrook and Sproul (Bambrook and Sproul, 2012) have graphically depicted the rate of heat generation and temperature increase as a function of the number of NTU transfer units, illustrating the influence of the key parameters values on the thermal performance of the PV/T air collector (see **Fig. 19**). To maximize thermal and electrical generation, a single-pass, unglazed, open-loop PV/T air system was designed in Sydney. The PV/T air collector was placed at a 34° tilt angle to the north and utilized six frameless 110 Wp of

PV modules. They found that the thermal and electrical efficiencies can be enhanced by increasing the air mass flow rate.

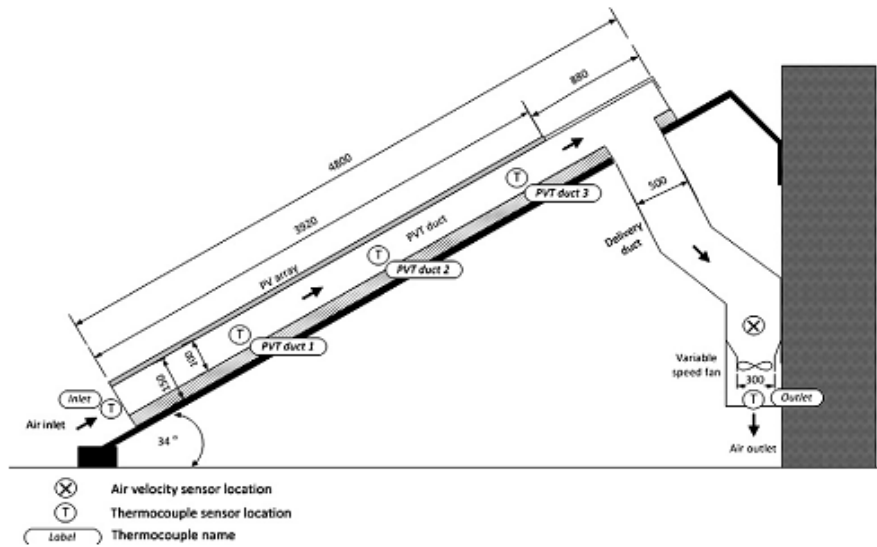

Fig.19: Schematic of experimental PV/T air system (Bambrook and Sproul, 2012).

BIPV/T air-based systems usually require a larger roof area to be installed, with the external surface serving as a building envelope or tile covering. As air absorbs the thermal energy generated by the PV cells, its temperature increases continuously as it passes through the module to reach higher values, which seriously reduces the fluid's ability to absorb heat. To tackle this problem, Yang and Athienitis (Yang and Athienitis, 2014) conceived a double-entry design, with the secondary entrance located midway up the airflow channel. Using this design, the thermal performance of the system is improved by about 5% (see **Fig.20**).

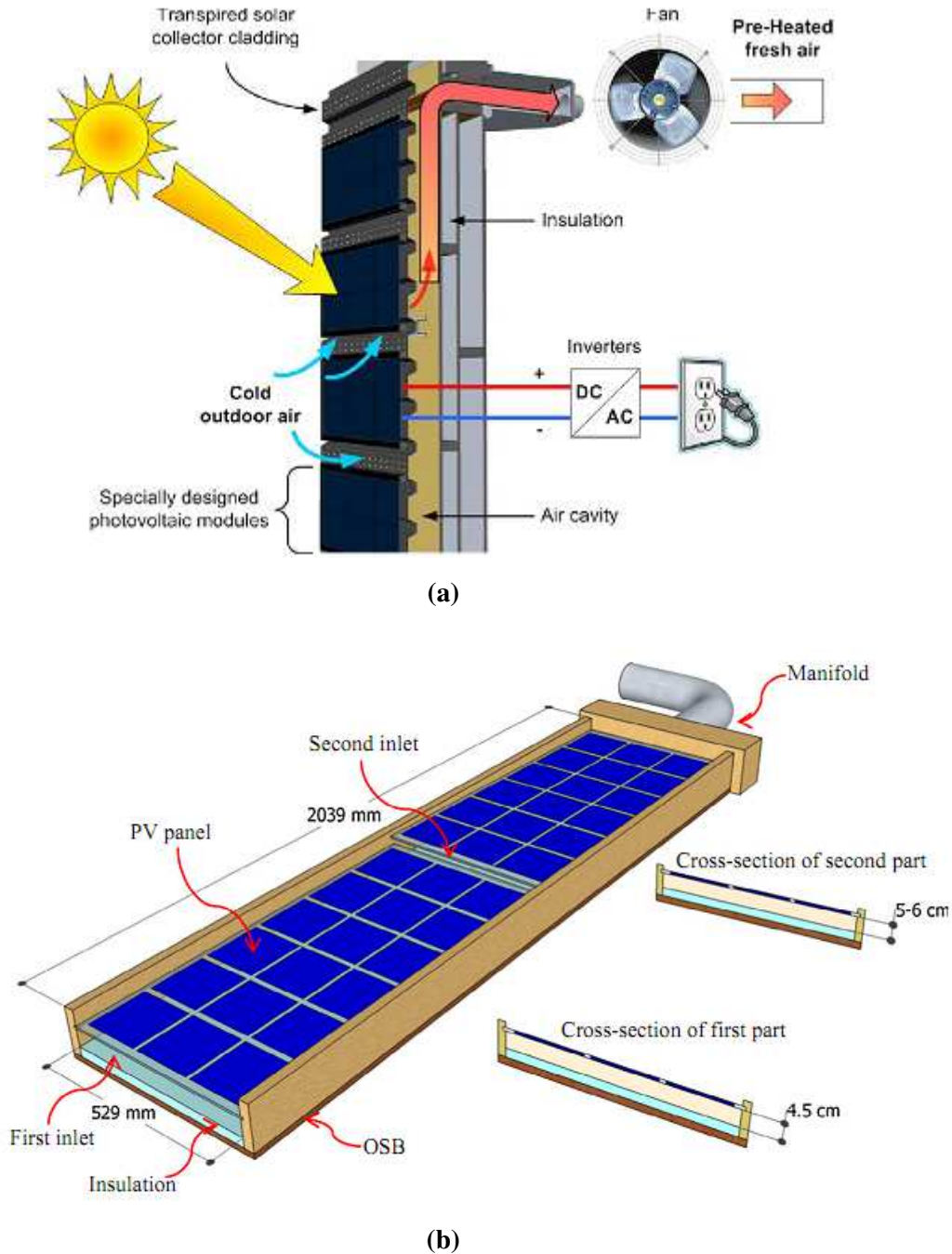

Fig.21: (a) Concept schematic for BIPV/T system (Yang and Athienitis, 2014), (b) Schematic of BIPV/T prototype with two inlets (Yang and Athienitis, 2015).

Yang and Athienitis (Yang and Athienitis, 2015) presented an upgraded BIPV/T system concept based on two inlets to enhance heat transfer between the air flowing and the PV modules (see Fig.21). Experimental designs of one- and two-entry BIPV/T systems were fabricated and a solar calculator was utilized to investigate the feasibility of the multiple-entry concept and its heat transfer characteristics. They have found that the two-input

BIPV/T system is able to enhance the thermal efficiency by 5% over the one-input system and is simple to install and without additional costs.

Saygin et al. (Saygin et al., 2017) explored a new design of the PV/T air system in Istanbul, Turkey (see **Fig.22**). In this system, air is introduced into the collector via a small hole located in the center of the glass cover. Since the air passes over and under the photovoltaic panel in opposed senses, it receives the surplus of thermal energy generated by the panel and chills it. Multiple measuring data have been recorded by varying the location of the PV module inside the collector and distance between the glass cover and PV panel. The authors found that the increase in air mass flow causes an increase in the pressure drop across the collector, however, this increase remained insignificant when the distance between the glass cover and PV panel is 3 cm.

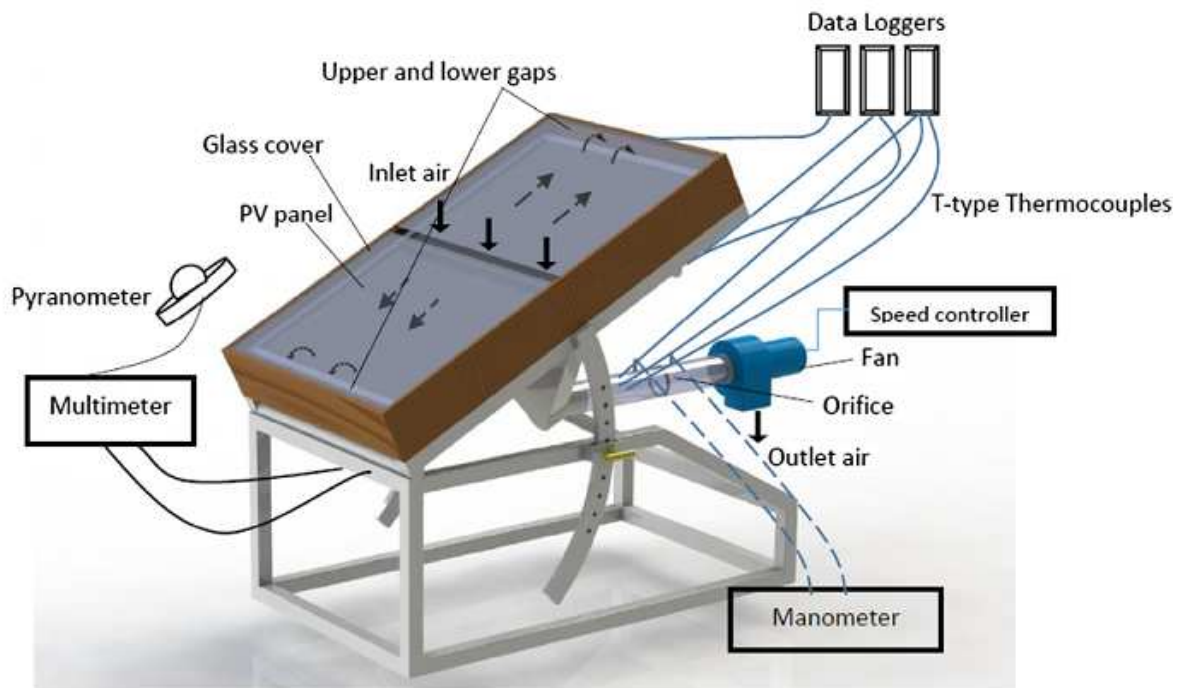

Fig.22: Schematic diagram of experimental set-up (Saygin et al., 2017).

Fudholi (Fudholi et al., 2019) carried out an experimental study to determine the exergy efficiency of the air PV/T system with a ∇ -corrugated absorber. The authors found that exergy efficiency of the system is ranged from 12.81% to 14.41%. Ahn et al. (Ahn et al., 2015) coupled an air PV/T collector with a heat recovery ventilation (HRV) system. Their experimental results showed that the thermal and electrical performances of the PV/T collector are 23 and 15% respectively and the overall efficiency of the coupled system is

38%. The authors concluded that the HRV system coupled with the air PV/T collector gave a higher efficiency than a simple HRV system. A number of air PV/T collector layouts (series and parallel air flow arrangement of microchannel solar cell thermal tiles, V-groove, honeycomb) have been explored by Othman et al. (Othman et al., 2013) (see **Fig. 23**). The authors found that better performances are obtained honeycomb design.

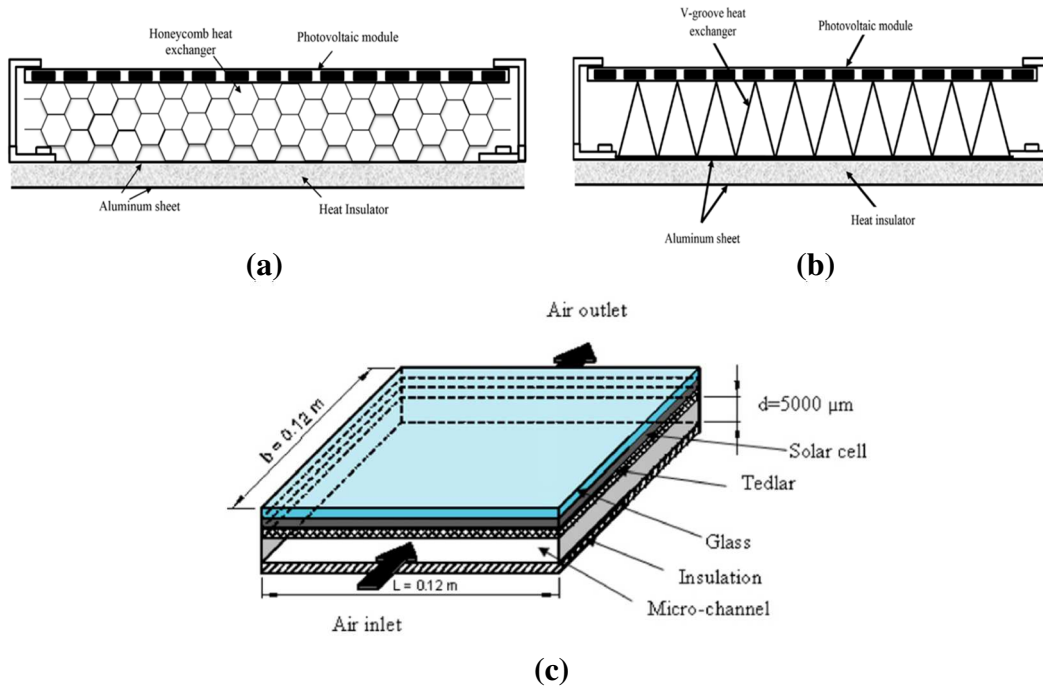

Fig.23: Air PV/T collectors with various heat exchanger designs: (a) honeycomb, (b) V-groove, (c) micro-channel solar cell thermal tile (Othman et al., 2013).

Kim et al. (Kim et al., 2014) investigated experimentally an air-based PV/T collector. They found that the thermal and electrical efficiencies of the PV/T collector were, on average, 22% and about 15%, respectively.

Franklin and Chandrasekar (Franklin and Chandrasekar, 2019) explored experimentally the effects of adding vertical fins to the back-side of the fluid duct of a PV/T air module. The authors found that under Tamilnadu (India) climate, the maximum possible outlet air temperature with and without fins was about 34 C and 30.7 C respectively.

An experimental study of a PV/T air module with a flat plate (Model-I) and wavy plate (Model-II) (see **Fig.24**) was carried out by Jha et al. (Jha et al., 2019a). The authors indicated that better thermal performances were obtained by using Model-II. The same authors (Jha et al., 2019b) investigated theoretically and experimentally the performance of a PV/T air collector under the climatic conditions of North East of India and for various

values of the air mass flow rate (0.007 kg/s, 0.0097 kg/s and 0.0128 kg/s). Better performances were noted for the mass flow rate of 0.0128 kg/s.

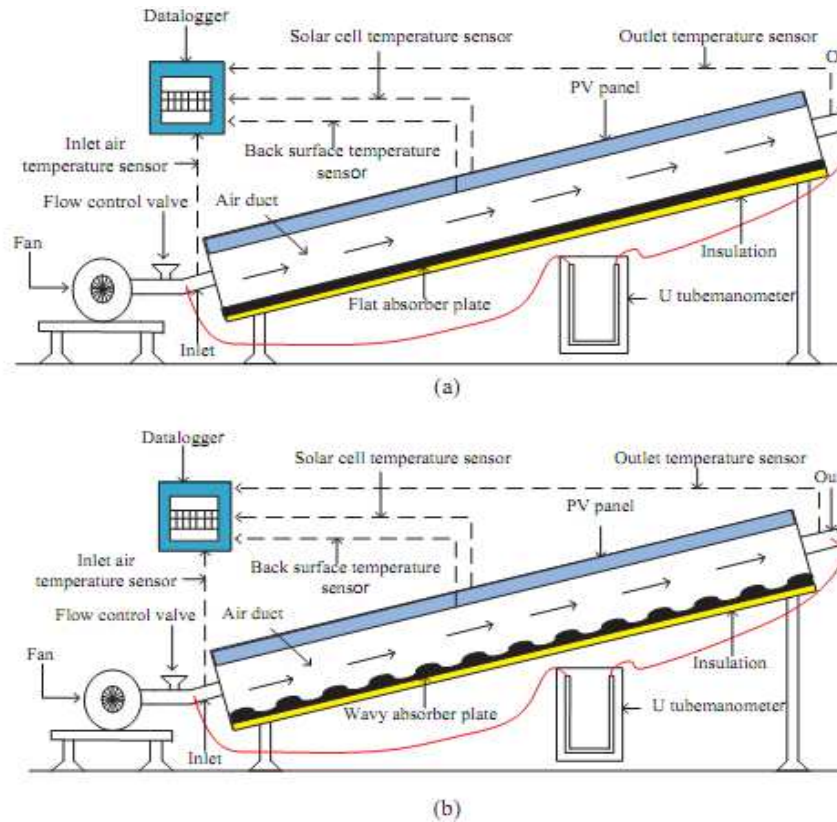

Fig. 24: Schematic diagram of PV/T air collectors (a) model-I with a flat plate; (b) model-II with the wavy plate at the base (Jha et al., 2019a).

Özakin and Kaya (Özakin and Kaya, 2019) presented the effect of the fins on exergy efficiency of the air-based PV/T collector. The authors performed various experiments according to frequent, sparse and empty situations of the air channel (see **Fig.25**). The authors also used ANSYS Fluent software to investigate numerical the PV/T air collector. The authors found that the use of sparse or frequent fins improve the exergy efficiency of the polycrystal and the monocrystal panels by approximately 70% and 30% respectively.

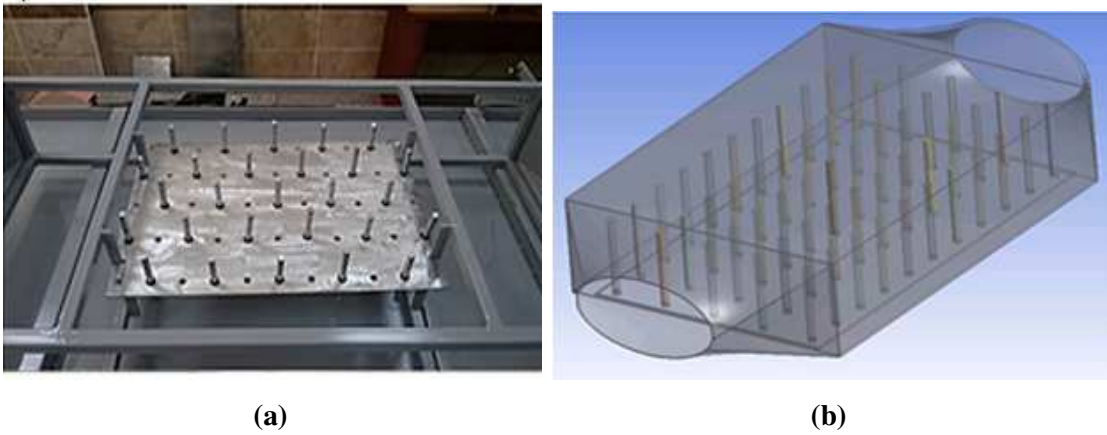

Fig.25: Experimental setup (a) - The mesh view of selected numerical model (b) (Özakin and Kaya, 2019).

Barone et al. (Barone et al., 2019) reported a new low-cost PV/T air plant concept coupled to an air-to-air heat pump (see Fig.26). The system was studied under various European weather conditions. The authors demonstrated the efficiency of the suggested system by assessing primary energy savings (11.0-19.7 MWh/year corresponding to 52-80%), avoided CO₂ emissions (4.64-10.4 tCO₂/year) and simple payback periods (3.2-4.8 years).

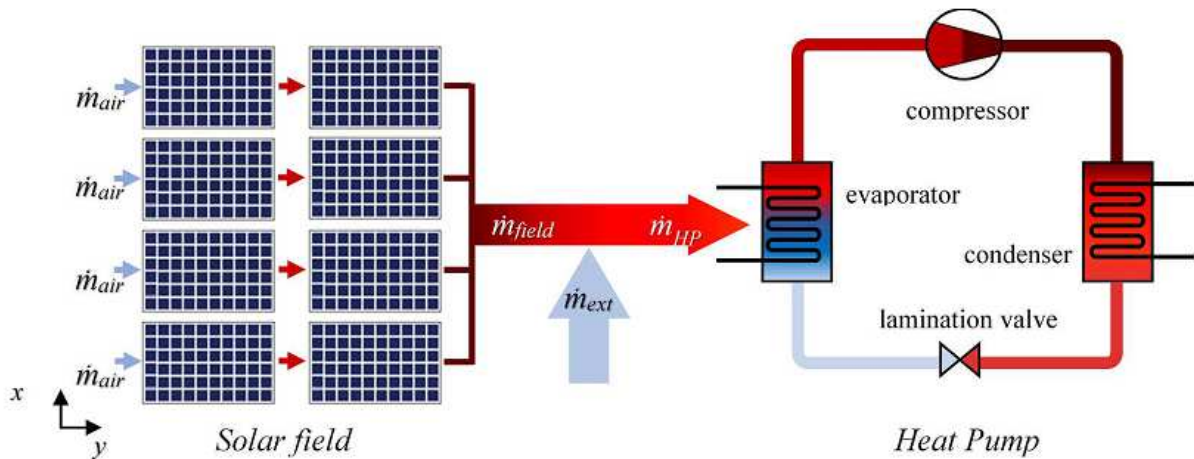

Fig.26: Sketch of the innovative air-based PV/T system + heat pump (Barone et al., 2019).

2.3 Mathematical optimization studies

A number of studies concerning the mathematical optimization of air-cooled PV/T collectors have recently been published in order to improve the overall performance of

this technology (Fan et al., 2018). Pottler et al. (Pottler et al., 1999) proposed a mathematical model to optimize air-based hybrid PV/T installations. Various designs (simple absorber, absorber with wavy plate and absorber with different geometries of fins) were investigated as depicted in **Fig.27**. The optimal distance between the fins was determined to be 5–10 mm. The authors confirmed that the use of fins provide a good thermal performance.

A multi-objective optimization on a glazed and unglazed PV/T system carried out by Vera et al. (Tamayo Vera et al., 2014) revealed the relationship conflicting between thermal and electrical efficiency as a function of mass flow rate, collector's length, packing factor and air gap. The optimal PV/T system design was obtained based on the Pareto front analysis, and the authors concluded that the optimization of PV/T systems using separated single objective could not lead to an overall optimal design.

Farshchimonfared et al. (Farshchimonfared et al., 2016) presented a detailed study to optimize the PV/T air system in relation to a standard residential building. Air temperature increase was not restricted during the optimization process. The results indicated the ability of optimally designed PV/T systems to provide substantially a similar net energy output over a wide range of air mass flow rates adapted to a variety of final applications with varying temperature rise needs.

Mojumder et al. (Mojumder et al., 2016a) investigated experimentally the effect of number of fins on the performance of an air type single pass PV/T collector (see **Fig.28**). The maximum thermal efficiency and PV efficiency were obtained about 56.19% and 13.75% respectively for four fins at 0.14 kg/s of mass flow rate and 700 W/m² of solar radiation. The same authors (Mojumder et al., 2016b) implemented three support vector machine (SVM) models combined with the discrete wavelet transform (SVM-Wavelet), the firefly algorithm (SVM-FFA) and the radial basis function (SVM-RBF) to evaluate the performances of the PV/T air system for different input parameters. The results of these approaches have been analyzed and compared. The authors demonstrated that SVM-Wavelet approach provides better results compared to other approaches.

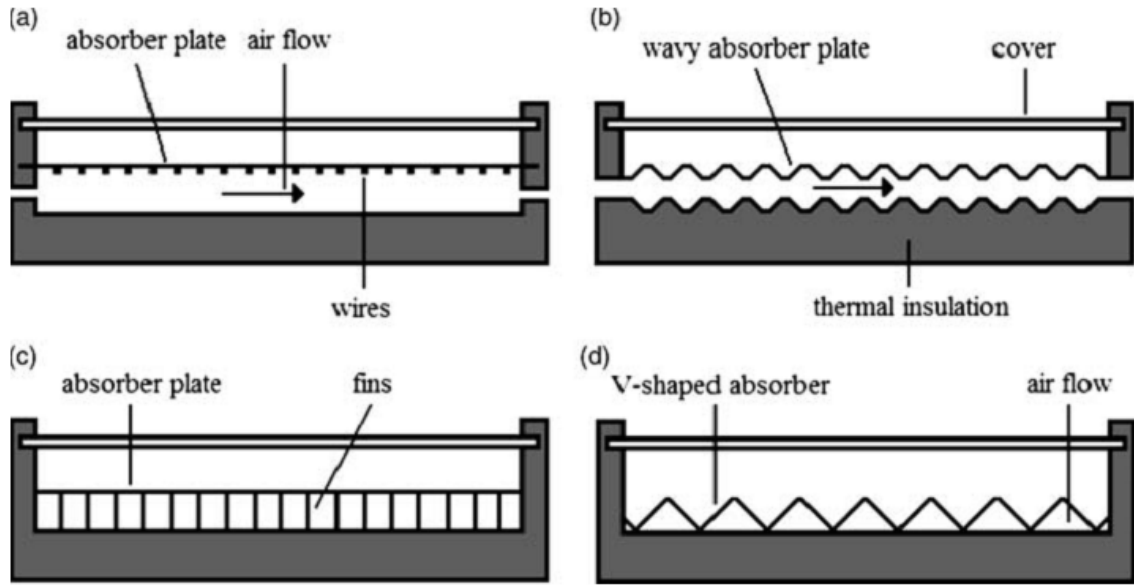

Fig.27: Hybrid air PV/T collectors with different configurations (Pottler et al., 1999).

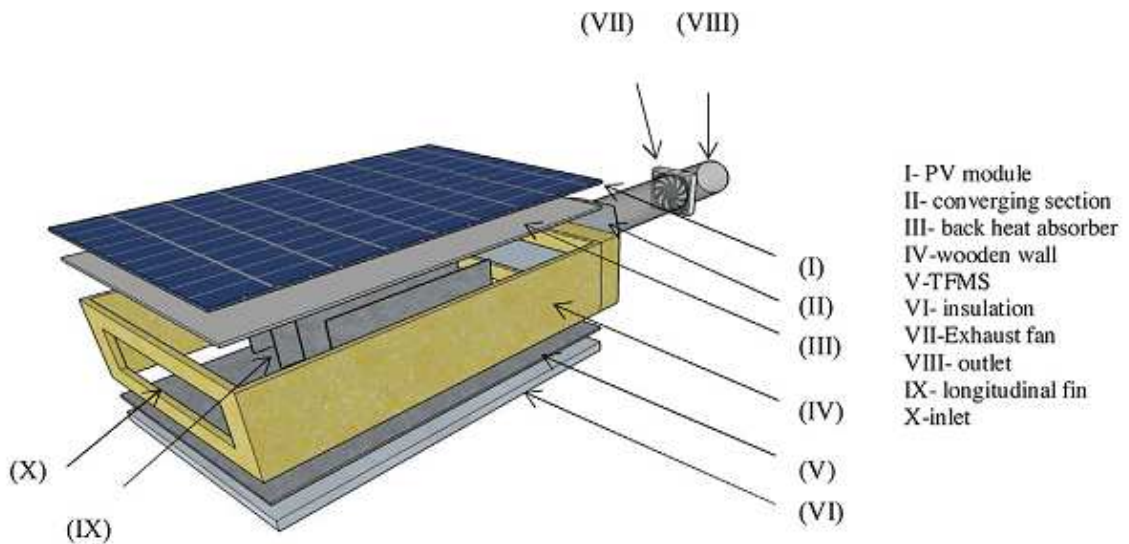

Fig.28: Schematic of the PV/T collector design (Mojumder et al., 2016a).

3. Discussions

According to the above literature review, the PV/T module performance is principally influenced by climate (i.e. solar irradiation, ambient temperature, wind speed), design (geometry and materials) and operating conditions (air mass flow rate and mode of flow) (Pang et al., 2020; Sellami et al., 2019). The most important outcomes that can be drawn from this literature review are:

- The increase in solar irradiation and wind speed is positively associated with the increase in PV/T air collector efficiency.
- PV/T air systems are generally able to convert solar energy into electricity and heat in the summer, but during the winter an auxiliary energy supply is needed to satisfy the energy demand.
- The increase in air mass flow rate improves the rate of heat transfer and reduces the air outlet temperature, leading to an increase in electrical and thermal efficiency.
- The geometry and dimensions of the collector have a considerable impact on the PV/T performance. Thermal efficiency increases significantly while electrical efficiency decreases slightly with increasing collector length. To extract the maximum amount of heat, the diameter of the air channel in the PV/T system should be as thin as possible.
- The implementation of double or triple air passes improves significantly the performance of PV/T air systems.
- The installation of fins, cross-corrugated surfaces, ribs, impinging jets and porous media in the fluid duct improves the thermal efficiency of the PV/T air system.
- Unglazed PV/T systems give a better electrical performance than glazed PV/T air systems. Glazed PV/T air systems are advisable to maximize thermal or overall energy efficiency.
- Increasing the packing factor leads to an increase in the temperature of the PV/T air collectors and thus reduce electrical efficiency.
- Multi-objective optimization is required to optimize the performance of PV/T air systems and provide decision makers a more detailed understanding of the system to address various needs.

Improving the performance of the system can also be achieved by the installation of vortex generators inside the air channel of PV/T system that allows the extraction of the maximum amount of heat accumulated in the collector (Abene et al., 2004). An additional important factor in optimizing the performance of PV/T collectors is the judicious choice of air circulation in the collector (Hu and Zhang, 2019). The following aspects can also improve PV/T air technologies:

- Accurate physical models of PV/T air systems are required to be developed, considering the consumers' needs.

- PV/T air collectors generate both heat and electricity. At geographical sites where both types of energy are not needed simultaneously, surplus of energy can be wasted. Such a problem can be addressed by the implementation of an energy storage system. This system needs to be designed appropriately and can effectively expand the market for PV/T systems.
- Commercially available PV/T air collectors are currently referred to devices that are even as expensive as other simpler and less expensive technologies. Low-cost PV/T collectors may solve this problem in the near future. From this point of view, a judicious combination of PV/T air collectors to an air-to-air heat pump can be of great interest for space heating applications.

4. Applications of PV/T air collector

Many PV/T air collector manufacturers are actively working to improve the performance of their products. Their primary goal is to improve the overall performance of PV/T air collectors. This performance enhancement depends on the PV market development, which is much larger than the global PV/T market.

The principal explanations for the restricted acceptability of air-based PV/T collectors are insufficient information on the systems and the lack of long-term data. More efforts are required to valorize PV/T collectors in order to present them as a key solution in PV and solar collectors. Recently, Industrial companies are converged to expand the use range of PV/T collectors. In this context, air-based PV/T systems represent a promising solution due to its diverse advantages of viability and cost-effectiveness.

Recently, the PV/T collector technology became very important, which led to the publication, for the first time, of market data in the International Energy Agency (IEA) Solar Heat World Wide 2019 edition (Task 60 IEA, 2020). According to this report, 1.1 million m² of area were covered by PV/T collectors by the end of 2018 worldwide. 90% of this installed area is located in France, South Korea, China, Germany and Israel, in the respective order. While most countries in the world have experienced growth in water-based PV/T systems, France is the exception with a majority market share for air-based PV/T s (Task 60 IEA, 2020).

Currently, renewable energy and energy efficiency are the most effective means of achieving a successful energy transition in the world (Chaibi et al., 2019a). The combination of these two concepts can reduce more than 90% of CO₂ emissions from energy (Maria and Yassine, 2020), using safe, reliable, cost-effective and widely available technologies. Building Integrated Photovoltaic/thermal (BIPV/T) is among the systems that combine the two aspects: sustainable system to improve the building's energy efficiency. This technology offers an excellent opportunity for building sector to provide both electrical and thermal services (Kumar et al., 2015). In this section, classification by applications (residential, agricultural and industrial) of this technology is discussed.

4.1. Domestic applications

Most of the work identified in the literature has been devoted to the integration of PV/T air collectors in buildings. Finocchiaro et al. (Finocchiaro et al., 2016) suggested a PV/T air conditioning prototype for buildings and small offices. Their proposed system (Freescoo), has been tested under different conditions and compared to standard conventional systems (Finocchiaro et al., 2016). Good et al. (Good et al., 2015) developed a new solution to cover energy needs in residential applications. Accordingly, electrical and heat needs are covered using a rooftop PV and PV/T systems. Then, a comparative study of three solutions is discussed (Good et al., 2015). Crawford et al. (Crawford et al., 2006) compared two different PV technologies: crystalline (c:Si) and amorphous (a:Si) cells. Then, a heat recovery unit (HRU) was installed to heat the buildings. PV systems with and without HRU is assessed in terms of energy payback period (Crawford et al., 2006). Agrawal et al. (Agrawal and Tiwari, 2010) proposed a comparative study of a BIPV/T air collector using different PV module technologies. This assessment is elaborated in terms of produced energy, exergy efficiency and life cost performance (Agrawal and Tiwari, 2010). Delisle et al. (Delisle and Kummert, 2016) evaluated the possibility of integrating various PV/T air configurations into six buildings of different types and under various climates in Canada. The performances of the discussed BIPV/T are assessed in terms of cost benefits (Delisle and Kummert, 2016). Ben Nejma et al. (Nejma et al., 2013) coupled a PV/T air collector with a heat pump for a building located in France (Alps). Ahn et al. (Ahn et al., 2015) discussed the feasibility of integrating PV/T air collector on the building rooftop. This BIPV/T is coupled with a

ventilation system to improve the air quality inside the building and to heat water for domestic uses (Ahn et al., 2015). Yu et al. (J. S. Yu et al., 2019) discussed the performances of an air-type BIPV/T installed on the building-facade of an educational research facility located in Korea. This system was adopted for air-heating of the building classrooms (J. S. Yu et al., 2019).

The following table (**Table 1**) summarizes the main results obtained by the above-mentioned researchers.

Table 1: Reported works about domestic applications of PV/T air systems..

Authors	Year of publication	Application	Findings/Remarks
Crawford et al. (Crawford et al., 2006)	2006	Space heating	<ul style="list-style-type: none"> ◆ This study is dedicated to analyze the payback energy duration of three PV systems with and without heat recovery unit (HRU) in BIPV/T. ◆ All discussed systems reduce the payback duration.
Agrawal et al. (Agrawal and Tiwari, 2010)	2010	Space heating	<ul style="list-style-type: none"> ◆ Different cell technologies are adopted for BIPV/T system. ◆ The mono-crystalline technology presented a promised solution for building with high consumption of energy, and amorphous is more suitable for buildings in remote and urban places.
Ben Nejma et al. (Nejma et al., 2013)	2013	Space and water heating	<ul style="list-style-type: none"> ◆ Recovered heat form the PV/T air collector is used to rise the water temperature for domestic applications. ◆ This PV/T system is a promising solution for residential located in cold and remote areas.
Good et al. (Good et al., 2015)	2015	Space heating	<ul style="list-style-type: none"> ◆ Comparative study of three hybrid systems. ◆ PV/T collectors represents a good solution to cover building electrical and heat needs.
Ahn et al. (Ahn et al., 2015)	2015	Space and water heating	<ul style="list-style-type: none"> ◆ A solution of a PV/T air collector with a ventilation system is discussed for heating space and water.

Finocchiaro et al. (Finocchiaro et al., 2016)	2016	Space heating/cooling	<ul style="list-style-type: none"> ◆ This solution could be applicable on residential and small building offices. ◆ Competitive eco-friendly solution.
Delisle et al. (Delisle and Kummert, 2016)	2016	Space and water heating	<ul style="list-style-type: none"> ◆ Six buildings of different PV/T configurations are evaluated in terms of break-even cost. ◆ The utility of PV/T air collector in fresh air preheating is processing for cold zones.
Yu et al. (J. S. Yu et al., 2019)	2019	Space heating	<ul style="list-style-type: none"> ◆ A PV/T air collector is installed on the building-façade of an educational school. The recovered heat is used to heat the air inside classrooms.

From the analysis of **Table 1**, one can see that most PV/T air collector applications in buildings are oriented to space heating. It has been demonstrated that PV/T air collector systems are more suitable for cold areas and could be easily integrated on building facades or roofs.

4.2. Industrial and agricultural applications

The PV/T air collector has also been successfully installed and tested in various applications in both industrial and agricultural sectors. Barnwal and Tiwari (Barnwal and Tiwari, 2008) tested the performances of a PV/T air collector system installed on the roof of a greenhouse dryer. The utility of this PV/T was dedicated to dry fruits and vegetables, in addition of providing essential energy to operate the DC fan of the greenhouse. Athienitis et al. (Athienitis et al., 2011) developed a new prototype for fresh air preheating using a commercial PV/T air collector system. The proposed design has been integrated on the John Molson Building-façade of Business School in Montreal, Canada. Bambara et al. (Bambara, 2012) adopted the same system to preheat the fresh air. Cartmell et al. (Cartmell et al., 2004) provided a ventilated PV/T air system to ensure the space heating and to supply hot water to the Brockhill environment center at UK. This PV/T is mounted on the roof mounted of the center. In the same context, the proposed prototype by Aste et al. (Aste et al., 2008) was integrated on the building-façade of the Fiat Research Center (FRC) at Italy. Indeed, this commercial solution named as integrated solar roof (TIS) improved the electrical efficiency. Further, it provides an air conditioning of the FRC offices in the winter by preheating the fresh air, as well as in the summer (cooling).

The previously mentioned works are classified in **Table 2** according to the year of publication and the application of PV/T on air collectors.

Table 2: Reported works about commercial and agricultural applications of PV/T air systems.

Authors	Year of publication	Applications	Remarks
Cartmell et al. (Cartmell et al., 2004)	2004	Space/water heating	<ul style="list-style-type: none"> ◆ A commercial PV/T air collector to contribute in heating water and ensure space heating for large buildings.
Aste et al. (Aste et al., 2008)	2008	Space heating/cooling	<ul style="list-style-type: none"> ◆ A commercial integrated solar roof (TIS) for air conditioning is developed and implemented on the building-façade of the FRC center. ◆ The TIS solutions serves for cooling and heating the building offices.
Athienitis et al. (Athienitis et al., 2011)	2011	Fresh air preheating	<ul style="list-style-type: none"> ◆ The developed prototype could be applied on commercial and industrial façade-buildings located in cold urbane places.
Barnwal & Tiwari (Barnwal and Tiwari, 2008; Tiwari et al., 2016)	2008,2016	Greenhouse drying	<ul style="list-style-type: none"> ◆ Greenhouse dryer applied for agricultural employments. ◆ Sustainable, low cost/maintenances.

The reported remarks in **Table 2** explain that PV/T air collector systems are mostly adopted for space heating/cooling in large commercial buildings. In addition, these systems are employed to dry fruits and vegetables in the agricultural sector.

Table 3 provides a classification of different companies that adopts the use of PV/T air collector in different industrial process. In addition, the year of implementation and the area of application are also reported.

Table 3: Applications of PV/T air systems in industrial process (Ship Plants, n.d.; Task 49 IEA, 2020).

Location	Name	Starting year	Industrial process
Argentina	Grammer Solar Argentina	1980	Drying of tobacco
Indonesia	Malabar Tea Drying	1994	Tea Drying
China	FengLi Fruit Drying	2000	Heating air for fruit drying
Germany	Neumarkter Lammsbräu	2000	Pre-heating air for the drying process in the malthouse
India	Kaveri Agri-Care Pvt. Ltd.	2001	Drying "Coir Peat"
USA	Carriers & Sons	2002	Walnuts Drying
USA	Kreher's Poultry Farms	2002	Drying of chicken eggs
USA	Keyawa Orchards	2003	Walnuts Drying
Panama	Duran Coffee	2004	Coffee Drying
USA	Sunsweet Dryers	2004	Prune Drying
Costa Rica	Coopeldos	2005	Coffee Drying
Romania	Hofigal S.A.	2006	Drying of medicinal plants, herbs and fruits
USA	Rockland County	2006	Drying of waste
Romania	Aroma Plant Romania	2007	Dying of medicinal plants
Thailand	Inter Rubber Latex Co. Ltd.	2007	Drying of natural rubber
USA	Sonoma County Herb Exchange	2010	Drying of herbs
Vietnam	Grammer Solar Vietnam	2012	Textile production process
India	AMR Dal mill	2012	Drying of pulse
Germany	Penzkofer Autolackiererei	2013	Painting process
Mexico	ZACATECAS TERMOSOLAR DRYING PLANT	2017	Dehydrate of agricultural products

Some of the reported cases in [Table 3](#) are shown in [Fig.29](#). One can note that most of industrial companies used the PV/T air systems to preheat air in order to dry agricultural products. We can also note that PV/T systems are also adopted for painting/textile process.



Fig.29: Various application of PV/T air collector systems in industrial processes (Ship Plants, n.d.).

Conclusions

PV/T air collector is a very attractive technology and its potential benefits will continually progress as the efficiency increases, costs reduce, and the technical design challenges related to this technology are addressed. The current review reveals that PV/T systems are most suited for heating buildings and drying applications. Most air-based PV/T systems are Building Integrated PV/T. Different techniques have been developed to intensify the heat transfer between air and photovoltaic cells. These techniques include the use of thin metal sheets, corrugated surfaces, ribs, etc. However, this leads to an increase in the pressure drop and in the fan's power consumption. Research and development of new designs are essential to improve the overall efficiency of the PV/T air systems. Moreover, solutions to improve existing technologies are also useful. Since the thermal energy output of PV/T air collectors is in general low-temperature, a number of studies highlighted the need for designing new technological solutions, such as coupling to heat pumps, thermal storage solutions and other HVAC equipment, for efficient use of this energy.

Acknowledgments

The authors sincerely acknowledge the fund received from EUROSTAR under the project PV-SolAir.

References

- Abdelrazik, A.S., Al-Sulaiman, F.A., Saidur, R., Ben-Mansour, R., 2018. A review on recent development for the design and packaging of hybrid photovoltaic/thermal (PV/T) solar systems. *Renew. Sustain. Energy Rev.* 95, 110–129. <https://doi.org/10.1016/j.rser.2018.07.013>
- Abdul Hamid, S., Yusof Othman, M., Sopian, K., Zaidi, S.H., 2014. An overview of photovoltaic thermal combination (PV/T combi) technology. *Renew. Sustain. Energy Rev.* 38, 212–222. <https://doi.org/10.1016/j.rser.2014.05.083>
- Abene, A., Dubois, V., Le Ray, M., Ouagued, A., 2004. Study of a solar air flat plate collector: Use of obstacles and application for the drying of grape. *J. Food Eng.* 65, 15–22. <https://doi.org/10.1016/j.jfoodeng.2003.11.002>

- Agrawal, B., Tiwari, G.N., 2010. Life cycle cost assessment of building integrated photovoltaic thermal (BIPVT) systems. *Energy Build.* 42, 1472–1481. <https://doi.org/10.1016/j.enbuild.2010.03.017>
- Agrawal, S., Tiwari, A., 2011a. Experimental validation of glazed hybrid micro-channel solar cell thermal tile. *Sol. Energy* 85, 3046–3056. <https://doi.org/10.1016/j.solener.2011.09.003>
- Agrawal, S., Tiwari, G.N., 2013a. Overall energy, exergy and carbon credit analysis by different type of hybrid photovoltaic thermal air collectors. *Energy Convers. Manag.* 65, 628–636. <https://doi.org/10.1016/j.enconman.2012.09.020>
- Agrawal, S., Tiwari, G.N., 2013b. Enviroeconomic analysis and energy matrices of glazed hybrid photovoltaic thermal module air collector. *Sol. Energy* 92, 139–146. <https://doi.org/10.1016/j.solener.2013.02.019>
- Agrawal, S., Tiwari, G.N., 2012. Exergoeconomic analysis of glazed hybrid photovoltaic thermal module air collector. *Sol. Energy* 86, 2826–2838. <https://doi.org/10.1016/j.solener.2012.06.021>
- Agrawal, S., Tiwari, G.N., 2011b. Energy and exergy analysis of hybrid micro-channel photovoltaic thermal module. *Sol. Energy* 85, 356–370. <https://doi.org/10.1016/j.solener.2010.11.013>
- Ahn, J.G., Kim, J.H.J.T.J.H., Kim, J.H.J.T.J.H., 2015. A study on experimental performance of air-type PV/T collector with HRV. *Energy Procedia* 78, 3007–3012. <https://doi.org/10.1016/j.egypro.2015.11.705>
- Alfegi, M.E.A., Sopian, K., Othman, M.Y.H., Yatim, B. Bin, 2008. Experimental Investigation of Single Pass, Double Duct Photovoltaic Thermal (PV/T) Air Collector with CPC and Fins. *Am. J. Appl. Sci.* 5, 866–871. <https://doi.org/10.3844/ajassp.2008.866.871>
- Allouhi, A., Saadani, R., Buker, M.S., Kousksou, T., Jamil, A., Rahmoune, M., 2019. Energetic, economic and environmental (3E) analyses and LCOE estimation of three technologies of PV grid-connected systems under different climates. *Sol. Energy* 178, 25–36. <https://doi.org/10.1016/j.solener.2018.11.060>
- Aste, N., Beccali, M., Chiesa, G., 2002. Experimental Evaluation of the Performance of a Proto- Type Hybrid Solar Photovoltaic-Thermal (Pv / T) Air Collector for the

Integration in Sloped Roof. 23rd AIVC Epic 2002 Conf. (in conjunction with 3rd Eur. Conf. Energy Perform. Indoor Clim. Build. "Energy Effic. Heal. Build. Sustain. cities.

Aste, N., Chiesa, G., Verri, F., 2008. Design, development and performance monitoring of a photovoltaic-thermal (PVT) air collector. *Renew. Energy* 33, 914–927. <https://doi.org/10.1016/j.renene.2007.06.022>

Athienitis, A.K., Bambara, J., O'Neill, B., Faille, J., 2011. A prototype photovoltaic/thermal system integrated with transpired collector. *Sol. Energy* 85, 139–153. <https://doi.org/10.1016/j.solener.2010.10.008>

Avezov, R.R., Akhatov, J.S., Avezova, N.R., 2011. A review on photovoltaic-thermal (PV-T) air and water collectors. *Appl. Sol. Energy (English Transl. Geliotekhnika)* 47, 169–183. <https://doi.org/10.3103/S0003701X11030042>

Bambara, J., 2012. Experimental Study of a Façade-integrated Photovoltaic/thermal System with Unglazed Transpired Collector. *Build. Eng.*

Bambook, S.M., Sproul, A.B., 2016. A solvable thermal circuit for modelling PVT air collectors. *Sol. Energy* 138, 77–87. <https://doi.org/10.1016/j.solener.2016.09.007>

Bambook, S.M., Sproul, A.B., 2012. Maximising the energy output of a PVT air system. *Sol. Energy* 86, 1857–1871. <https://doi.org/10.1016/j.solener.2012.02.038>

Barnwal, P., Tiwari, G.N., 2008. Life cycle energy metrics and CO₂ credit analysis of a hybrid photovoltaic/thermal greenhouse dryer. *Int. J. Low Carbon Technol.* 3, 203–220. <https://doi.org/10.1093/ijlct/3.3.203>

Barone, G., Buonomano, A., Forzano, C., Palombo, A., Panagopoulos, O., 2019. Experimentation, modelling and applications of a novel low-cost air-based photovoltaic thermal collector prototype. *Energy Convers. Manag.* 195, 1079–1097. <https://doi.org/10.1016/j.enconman.2019.04.082>

Brekke, N., Dale, J., DeJarnette, D., Hari, P., Orosz, M., Roberts, K., Tunkara, E., Otanicar, T., 2018. Detailed performance model of a hybrid photovoltaic/thermal system utilizing selective spectral nanofluid absorption. *Renew. Energy* 123, 683–693. <https://doi.org/10.1016/j.renene.2018.01.025>

Brideau, S.A., Collins, M.R., 2014. Development and validation of a hybrid PV/Thermal air based collector model with impinging jets. *Sol. Energy* 102, 234–246.

- <https://doi.org/10.1016/j.solener.2014.01.022>
- Brideau, S.A., Collins, M.R., 2012. Experimental model validation of a hybrid PV/thermal air based collector with impinging jets. *Energy Procedia* 30, 44–54. <https://doi.org/10.1016/j.egypro.2012.11.007>
- Brinkworth, B.J., 2002. Coupling of Convective and Radiative Heat Transfer in PV Cooling Ducts. *J. Sol. Energy Eng* 124, 250–255.
- Cartmell, B.P., Shankland, N.J., Fiala, D., Hanby, V., 2004. A multi-operational ventilated photovoltaic and solar air collector: Application, simulation and initial monitoring feedback. *Sol. Energy* 76, 45–53. <https://doi.org/10.1016/j.solener.2003.08.037>
- Chaibi, Y., Allouhi, A., Salhi, M., 2020. A simple iterative method to determine the electrical parameters of photovoltaic cell. *J. Clean. Prod.* 122363. <https://doi.org/10.1016/j.jclepro.2020.122363>
- Chaibi, Y., Allouhi, A., Salhi, M., El-jouni, A., 2019a. Annual performance analysis of different maximum power point tracking techniques used in photovoltaic systems. *Prot. Control Mod. Power Syst.* 4. <https://doi.org/10.1186/s41601-019-0129-1>
- Chaibi, Y., Malvoni, M., Chouder, A., Boussetta, M., Salhi, M., 2019b. Simple and efficient approach to detect and diagnose electrical faults and partial shading in photovoltaic systems. *Energy Convers. Manag.* 196, 330–343. <https://doi.org/10.1016/j.enconman.2019.05.086>
- Chow, T.T., 2010. A review on photovoltaic/thermal hybrid solar technology. *Appl. Energy* 87, 365–379. <https://doi.org/10.1016/j.apenergy.2009.06.037>
- Chow, T.T., 2003. Performance analysis of photovoltaic-thermal collector by explicit dynamic model. *Sol. Energy* 75, 143–152. <https://doi.org/10.1016/j.solener.2003.07.001>
- Cox, C.H., Raghuraman, P., 1985. Design considerations for flat-plate-photovoltaic/thermal collectors. *Sol. Energy* 35, 227–241. [https://doi.org/10.1016/0038-092X\(85\)90102-1](https://doi.org/10.1016/0038-092X(85)90102-1)
- Crawford, R.H., Treloar, G.J., Fuller, R.J., Bazilian, M., 2006. Life-cycle energy analysis of building integrated photovoltaic systems (BiPVs) with heat recovery unit. *Renew. Sustain. Energy Rev.* 10, 559–575. <https://doi.org/10.1016/j.rser.2004.11.005>

- Das, D., Kalita, P., Roy, O., 2018. Flat plate hybrid photovoltaic- thermal (PV/T) system: A review on design and development. *Renew. Sustain. Energy Rev.* 84, 111–130. <https://doi.org/10.1016/j.rser.2018.01.002>
- Delisle, V., Kummert, M., 2016. Cost-benefit analysis of integrating BIPV-T air systems into energy-efficient homes. *Sol. Energy* 136, 385–400. <https://doi.org/10.1016/j.solener.2016.07.005>
- Diwania, S., Agrawal, S., Siddiqui, A.S., Singh, S., 2020. Photovoltaic–thermal (PV/T) technology: a comprehensive review on applications and its advancement. *Int. J. Energy Environ. Eng.* 11, 33–54. <https://doi.org/10.1007/s40095-019-00327-y>
- Dubey, S., Sandhu, G.S., Tiwari, G.N., 2009a. Analytical expression for electrical efficiency of PV/T hybrid air collector. *Appl. Energy* 86, 697–705. <https://doi.org/10.1016/j.apenergy.2008.09.003>
- Dubey, S., Solanki, S.C., Tiwari, A., 2009b. Energy and exergy analysis of PV/T air collectors connected in series. *Energy Build.* 41, 863–870. <https://doi.org/10.1016/j.enbuild.2009.03.010>
- Elsafi, A., Gandhidasan, P., 2015. Performance of a Photovoltaic or Thermal Double-Pass Solar Air Heater with Different Fin Configurations. *J. Clean Energy Technol.* 3, 28–33. <https://doi.org/10.7763/jocet.2015.v3.163>
- Fan, W., Kokogiannakis, G., Ma, Z., 2018. A multi-objective design optimisation strategy for hybrid photovoltaic thermal collector (PVT)-solar air heater (SAH) systems with fins. *Sol. Energy* 163, 315–328. <https://doi.org/10.1016/j.solener.2018.02.014>
- Farshchimofared, M., Bilbao, J.I., Sproul, A.B., 2016. Full optimisation and sensitivity analysis of a photovoltaic–thermal (PV/T) air system linked to a typical residential building. *Sol. Energy* 136, 15–22. <https://doi.org/10.1016/j.solener.2016.06.048>
- Fine, J.P., Dworkin, S.B., Friedman, J., 2019. A methodology for predicting hybrid solar panel performance in different operating modes. *Renew. Energy* 130, 1198–1206. <https://doi.org/10.1016/j.renene.2018.08.082>
- Finocchiaro, P., Beccali, M., Cellura, M., Guarino, F., Longo, S., 2016. Life Cycle Assessment of a compact Desiccant Evaporative Cooling system: The case study of the “Freescoo.” *Sol. Energy Mater. Sol. Cells* 156, 83–91. <https://doi.org/10.1016/j.solmat.2016.03.026>

- Franklin, J.C., Chandrasekar, M., 2019. Performance enhancement of a single pass solar photovoltaic thermal system using staves in the trailing portion of the air channel. *Renew. Energy* 135, 248–258. <https://doi.org/10.1016/j.renene.2018.12.004>
- Fudholi, A., Sopian, K., Bakhtyar, B., Gabbasa, M., Othman, M.Y., Ruslan, M.H., 2015. Review of solar drying systems with air based solar collectors in Malaysia. *Renew. Sustain. Energy Rev.* 51, 1191–1204. <https://doi.org/10.1016/j.rser.2015.07.026>
- Fudholi, A., Zohri, M., Rukman, N.S.B., Nazri, N.S., Mustapha, M., Yen, C.H., Mohammad, M., Sopian, K., 2019. Exergy and sustainability index of photovoltaic thermal (PVT) air collector: A theoretical and experimental study. *Renew. Sustain. Energy Rev.* 100, 44–51. <https://doi.org/10.1016/j.rser.2018.10.019>
- Garg, H.P., Adhikari, R.S., 1999. System Performance Studies On a Photovoltaic Thermal (PV/T) Air Heating Collector. *Renew. Energy* 16, 725–730.
- Garg, H. P., Adhikari, R.S., 1999. Performance analysis of a hybrid photovoltaic/thermal (PV/T) collector with integrated CPC troughs. *Int. J. Energy Res.* 23, 1295–1304. [https://doi.org/10.1002/\(SICI\)1099-114X\(199912\)23:15<1295::AID-ER553>3.0.CO;2-T](https://doi.org/10.1002/(SICI)1099-114X(199912)23:15<1295::AID-ER553>3.0.CO;2-T)
- Garg, H.P., Adhikari, R.S., 1997. Conventional hybrid photovoltaic/thermal (PV/T) air heating collectors: Steady-state simulation. *Renew. Energy* 11, 363–385. [https://doi.org/10.1016/S0960-1481\(97\)00007-4](https://doi.org/10.1016/S0960-1481(97)00007-4)
- Good, C., Andresen, I., Hestnes, A.G., 2015. Solar energy for net zero energy buildings - A comparison between solar thermal, PV and photovoltaic-thermal (PV/T) systems. *Sol. Energy* 122, 986–996. <https://doi.org/10.1016/j.solener.2015.10.013>
- He, W., Chow, T.T., Ji, J., Lu, J., Pei, G., Chan, L.S., 2006. Hybrid photovoltaic and thermal solar-collector designed for natural circulation of water. *Appl. Energy* 83, 199–210. <https://doi.org/10.1016/j.apenergy.2005.02.007>
- Hegazy, A.A., 2000. Comparative study of the performances of four photovoltaic/thermal solar air collectors. *Energy Convers. Manag.* 41, 861–881.
- Hendrie, S.D., 1982. Photovoltaic/thermal collector development program. Final report. United States.
- Hu, J., Zhang, G., 2019. Performance improvement of solar air collector based on airflow reorganization: A review. *Appl. Therm. Eng.* 155, 592–611.

<https://doi.org/10.1016/j.applthermaleng.2019.04.021>

- Hussain, F., Othman, M.Y.H., Sopian, K., Yatim, B., Ruslan, H., Othman, H., 2013. Design development and performance evaluation of photovoltaic/thermal (PV/T) air base solar collector. *Renew. Sustain. Energy Rev.* 25, 431–441. <https://doi.org/10.1016/j.rser.2013.04.014>
- Ibrahim, A., Jin, G.L., Daghigh, R., Salleh, M.H.M., Othman, M.Y., Ruslan, M.H., Mat, S., Sopian, K., 2009. Hybrid photovoltaic thermal (PV/T) air and water based solar collectors suitable for building integrated applications. *Am. J. Environ. Sci.* <https://doi.org/10.3844/ajessp.2009.618.624>
- Ibrahim, A., Othman, M.Y., Ruslan, M.H., Mat, S., Sopian, K., 2011. Recent advances in flat plate photovoltaic/thermal (PV/T) solar collectors. *Renew. Sustain. Energy Rev.* 15, 352–365. <https://doi.org/10.1016/j.rser.2010.09.024>
- Jha, P., Das, B., Gupta, R., 2019a. An experimental study of a photovoltaic thermal air collector (PVTAC): A comparison of a flat and the wavy collector. *Appl. Therm. Eng.* 163, 114344. <https://doi.org/10.1016/j.applthermaleng.2019.114344>
- Jha, P., Das, B., Gupta, R., 2019b. Energy and exergy analysis of photovoltaic thermal air collector under climatic condition of North Eastern India. *Energy Procedia* 158, 1161–1167. <https://doi.org/10.1016/j.egypro.2019.01.299>
- Jia, Y., Alva, G., Fang, G., 2019. Development and applications of photovoltaic–thermal systems: A review. *Renew. Sustain. Energy Rev.* 102, 249–265. <https://doi.org/10.1016/j.rser.2018.12.030>
- Jin, G.O.H.L.I., Ibrahim, A., Chean, Y.E.E.K.I.M., Daghigh, R., Ruslan, H., Mat, S., Othman, M.Y., Ibrahim, K., Zaharim, A., Sopian, K., n.d. Evaluation of Single-Pass Photovoltaic-Thermal Air Collector with Rectangle Tunnel Absorber. *Recent Adv. Appl. Math.* 493–498.
- Joshi, A.S., Tiwari, A., 2007. Energy and exergy efficiencies of a hybrid photovoltaic-thermal (PV/T) air collector. *Renew. Energy* 32, 2223–2241. <https://doi.org/10.1016/j.renene.2006.11.013>
- Kamthania, D., Nayak, S., Tiwari, G.N., 2011. Energy and exergy analysis of a hybrid photovoltaic thermal double pass air collector. *Appl. Sol. Energy (English Transl. Geliotekhnika)* 47, 199–206. <https://doi.org/10.3103/S0003701X11030066>

- Kern, E.C., Russell, M.C., 1978. COMBINED PHOTOVOLTAIC AND THERMAL HYBRID COLLECTOR SYSTEMS ', in: 13th IEEE PHOTOVOLTAIC SPECIALISTS' CONFERENCE.
- Khelifa, A., Touafek, K., Moussa, H. Ben, Tabet, I., Hocine, H.B.C. El, Haloui, H., 2015. Analysis of a Hybrid Solar Collector Photovoltaic Thermal (PVT). *Energy Procedia* 74, 835–843. <https://doi.org/10.1016/j.egypro.2015.07.819>
- Kim, J.H., Park, S.H., Kim, J.T., 2014. Experimental performance of a photovoltaic-thermal air collector. *Energy Procedia* 48, 888–894. <https://doi.org/10.1016/j.egypro.2014.02.102>
- Kumar, A., Baredar, P., Qureshi, U., 2015. Historical and recent development of photovoltaic thermal (PVT) technologies. *Renew. Sustain. Energy Rev.* 42, 1428–1436. <https://doi.org/10.1016/j.rser.2014.11.044>
- Kumar, R., Rosen, M.A., 2011a. Performance evaluation of a double pass PV/T solar air heater with and without fins. *Appl. Therm. Eng.* 31, 1402–1410. <https://doi.org/10.1016/j.applthermaleng.2010.12.037>
- Kumar, R., Rosen, M.A., 2011b. A critical review of photovoltaic-thermal solar collectors for air heating. *Appl. Energy* 88, 3603–3614. <https://doi.org/10.1016/j.apenergy.2011.04.044>
- Lin, W., Ma, Z., Ren, H., Gschwander, S., Wang, S., 2019. Multi-objective optimisation of thermal energy storage using phase change materials for solar air systems. *Renew. Energy* 130, 1116–1129. <https://doi.org/10.1016/j.renene.2018.08.071>
- Maria, M., Yassine, C., 2020. Machine learning based approaches for modeling the output power of photovoltaic array in real outdoor conditions. *Electron.* 9, 315. <https://doi.org/10.3390/electronics9020315>
- Mei, L., Infield, D., Eicker, U., Loveday, D., Fux, V., 2006. Cooling potential of ventilated PV façade and solar air heaters combined with a desiccant cooling machine. *Renew. Energy* 31, 1265–1278. <https://doi.org/10.1016/j.renene.2005.06.013>
- Mojumder, J.C., Chong, W.T., Ong, H.C., Leong, K.Y., Abdullah-Al-Mamoon, 2016a. An experimental investigation on performance analysis of air type photovoltaic thermal collector system integrated with cooling fins design. *Energy Build.* 130,

272–285. <https://doi.org/10.1016/j.enbuild.2016.08.040>

- Mojumder, J.C., Ong, H.C., Chong, W.T., Izadyar, N., Shamshirband, S., 2017. The intelligent forecasting of the performances in PV/T collectors based on soft computing method. *Renew. Sustain. Energy Rev.* 72, 1366–1378. <https://doi.org/10.1016/j.rser.2016.11.225>
- Mojumder, J.C., Ong, H.C., Chong, W.T., Shamshirband, S., Abdullah-Al-Mamoon, 2016b. Application of support vector machine for prediction of electrical and thermal performance in PV/T system. *Energy Build.* 111, 267–277. <https://doi.org/10.1016/j.enbuild.2015.11.043>
- Nazri, N.S., Fudholi, A., Mustafa, W., Yen, C.H., Mohammad, M., Ruslan, M.H., Sopian, K., 2019. Exergy and improvement potential of hybrid photovoltaic thermal/thermoelectric (PVT/TE) air collector. *Renew. Sustain. Energy Rev.* 111, 132–144. <https://doi.org/10.1016/j.rser.2019.03.024>
- Nejma, H. Ben, Guiavarch, A., Lokhat, I., Auzenet, E., Claudon, F., Peuportier, B., Léman, L., Technolac, S., Bourget, L., 2013. IN-SITU PERFORMANCE EVALUATION BY SIMULATION OF A COUPLED AIR SOURCE HEAT PUMP/PV-T COLLECTOR SYSTEM, in: *Proceedings of BS2013*. pp. 1927–1935.
- Othman, M.Y., Yatim, B., Sopian, K., Abu Bakar, M.N., 2007. Performance studies on a finned double-pass photovoltaic-thermal (PV/T) solar collector. *Desalination* 209, 43–49. <https://doi.org/10.1016/j.desal.2007.04.007>
- Othman, M.Y.H., Hussain, F., Sopian, K., Yatim, B., Ruslan, H., 2013. Performance study of air-based photovoltaic-thermal (PV/T) collector with different designs of heat exchanger. *Sains Malaysiana* 42, 1319–1325.
- Othman, M.Y.H., Sopian, K., Yatim, B., Daud, W.R.W., 2006. Development of advanced solar assisted drying systems. *Renew. Energy* 31, 703–709. <https://doi.org/10.1016/j.renene.2005.09.004>
- Othman, M.Y.H., Yatim, B., Sopian, K., Abu Bakar, M.N., 2005. Performance analysis of a double-pass photovoltaic/thermal (PV/T) solar collector with CPC and fins. *Renew. Energy* 30, 2005–2017. <https://doi.org/10.1016/j.renene.2004.10.007>
- Özakin, A.N., Kaya, F., 2019. Effect on the exergy of the PVT system of fins added to an air-cooled channel: A study on temperature and air velocity with ANSYS Fluent.

- Sol. Energy 184, 561–569. <https://doi.org/10.1016/j.solener.2019.03.100>
- Pang, W., Cui, Y., Zhang, Q., Wilson, G.J., Yan, H., 2020. A comparative analysis on performances of flat plate photovoltaic/thermal collectors in view of operating media, structural designs, and climate conditions. *Renew. Sustain. Energy Rev.* 119, 109599. <https://doi.org/10.1016/j.rser.2019.109599>
- Posnansky, M., Szacsavay, T., Eckmanns, A., Jürgens, J., 1998. New electricity construction materials for roofs and façades. *Renew. energy* 15, 541–544.
- Pottler, K., Sippel, C.M., Beck, A., Fricke, J., 1999. Optimized finned absorber geometries for solar air heating collectors. *Sol. Energy* 67, 35–52. [https://doi.org/10.1016/S0038-092X\(00\)00036-0](https://doi.org/10.1016/S0038-092X(00)00036-0)
- Prakash, C., 1986. An Improved Control Volume Finite-Element Method For Heat and Mass Transfer, and for Fluid Flow Using Equal-Order Velocity-Pressure Interpolation. *Numer. Heat Transf. Part A Appl.* 9, 253–276.
- Rajoria, C.S., Agrawal, S., Tiwari, G.N., 2013. Exergetic and enviroeconomic analysis of novel hybrid PVT array. *Sol. Energy* 88, 110–119. <https://doi.org/10.1016/j.solener.2012.11.018>
- Rajoria, C.S., Agrawal, S., Tiwari, G.N., 2012. Overall thermal energy and exergy analysis of hybrid photovoltaic thermal array. *Sol. Energy* 86, 1531–1538. <https://doi.org/10.1016/j.solener.2012.02.014>
- Rajoria, C.S., Agrawal, S., Tiwari, G.N., Chaurasia, G.S., 2015. Exergetic and enviroeconomic analysis of semitransparent PVT array based on optimum air flow configuration and its comparative study. *Sol. Energy* 122, 1138–1145. <https://doi.org/10.1016/j.solener.2015.10.020>
- Rejeb, O., Gaillard, L., Giroux-Julien, S., Ghenai, C., Jemni, A., Bettayeb, M., Menezo, C., 2020. Novel solar PV/Thermal collector design for the enhancement of thermal and electrical performances. *Renew. Energy* 146, 610–627. <https://doi.org/10.1016/j.renene.2019.06.158>
- Riffat, S.B., Cuce, E., 2011. A review on hybrid photovoltaic/thermal collectors and systems. *Int. J. Low-Carbon Technol.* 6, 212–241. <https://doi.org/10.1093/ijlct/ctr016>
- Sarhaddi, F., Farahat, S., Ajam, H., Behzadmehr, A., 2010a. Exergetic performance

- assessment of a solar photovoltaic thermal (PV/T) air collector. *Energy Build.* 42, 2184–2199. <https://doi.org/10.1016/j.enbuild.2010.07.011>
- Sarhaddi, F., Farahat, S., Ajam, H., Behzadmehr, A., Mahdavi Adeli, M., 2010b. An improved thermal and electrical model for a solar photovoltaic thermal (PV/T) air collector. *Appl. Energy* 87, 2328–2339. <https://doi.org/10.1016/j.apenergy.2010.01.001>
- Saygin, H., Nowzari, R., Mirzaei, N., Aldabbagh, L.B.Y., 2017. Performance evaluation of a modified PV/T solar collector: A case study in design and analysis of experiment. *Sol. Energy* 141, 210–221. <https://doi.org/10.1016/j.solener.2016.11.048>
- Sellami, R., Amirat, M., Mahrane, A., Slimani, M.E.A., Arbane, A., Chekrouni, R., 2019. Experimental and numerical study of a PV/Thermal collector equipped with a PV-assisted air circulation system: Configuration suitable for building integration. *Energy Build.* 190, 216–234. <https://doi.org/10.1016/j.enbuild.2019.03.007>
- Shah, R., Srinivasan, P., 2018. Hybrid Photovoltaic and Solar Thermal Systems (PVT): Performance Simulation and Experimental Validation. *Mater. Today Proc.* 5, 22998–23006. <https://doi.org/10.1016/j.matpr.2018.11.028>
- Shahsavari, A., Ameri, M., 2010. Experimental investigation and modeling of a direct-coupled PV/T air collector. *Sol. Energy* 84, 1938–1958. <https://doi.org/10.1016/j.solener.2010.07.010>
- Ship Plants, n.d. Database for applications of solar heat integration in industrial processes.
- Siecker, J., Kusakana, K., Numbi, B.P., 2017. A review of solar photovoltaic systems cooling technologies. *Renew. Sustain. Energy Rev.* 79, 192–203. <https://doi.org/10.1016/j.rser.2017.05.053>
- Skoplaki, E., Palyvos, J.A., 2009. On the temperature dependence of photovoltaic module electrical performance: A review of efficiency/power correlations. *Sol. Energy* 83, 614–624. <https://doi.org/10.1016/j.solener.2008.10.008>
- Slimani, M.E.A., Amirat, M., Kurucz, I., Bahria, S., Hamidat, A., Chaouch, W.B., 2017. A detailed thermal-electrical model of three photovoltaic/thermal (PV/T) hybrid air collectors and photovoltaic (PV) module: Comparative study under Algiers climatic conditions. *Energy Convers. Manag.* 133, 458–476.

<https://doi.org/10.1016/j.enconman.2016.10.066>

Sopian, K., Liu, H.T., Kakac, S., Veziroglu, T.N., 2000. Performance of a double pass photovoltaic thermal solar collector suitable for solar drying systems. *Energy Convers. Manag.* 41, 353–365. [https://doi.org/10.1016/S0196-8904\(99\)00115-6](https://doi.org/10.1016/S0196-8904(99)00115-6)

Sopian, K., Yigit, K.S., Liu, H.T., Kakaç, S., Veziroglu, T.N., 1996. Performance analysis of photovoltaic thermal air heaters. *Energy Convers. Manag.* 37, 1657–1670. [https://doi.org/10.1016/0196-8904\(96\)00010-6](https://doi.org/10.1016/0196-8904(96)00010-6)

Su, D., Jia, Y., Huang, X., Alva, G., Tang, Y., Fang, G., 2016. Dynamic performance analysis of photovoltaic-thermal solar collector with dual channels for different fluids. *Energy Convers. Manag.* 120, 13–24. <https://doi.org/10.1016/j.enconman.2016.04.095>

Tamayo Vera, J., Laukkanen, T., Sirén, K., 2014. Performance evaluation and multi-objective optimization of hybrid photovoltaic-thermal collectors. *Sol. Energy* 102, 223–233. <https://doi.org/10.1016/j.solener.2014.01.014>

Task 49 IEA, 2020. Solar Heat Integrations in Industrial Processes.

Task 60 IEA, 2020. Existing PVT systems and solutions 125. <https://doi.org/10.18777/ieashc-task60-2020-0001>

Teo, H.G., Lee, P.S., Hawlader, M.N.A., 2012. An active cooling system for photovoltaic modules. *Appl. Energy* 90, 309–315. <https://doi.org/10.1016/j.apenergy.2011.01.017>

Tiwari, A., Sodha, M.S., 2007. Parametric study of various configurations of hybrid PV/thermal air collector: Experimental validation of theoretical model. *Sol. Energy Mater. Sol. Cells* 91, 17–28. <https://doi.org/10.1016/j.solmat.2006.06.061>

Tiwari, A., Sodha, M.S., Chandra, A., Joshi, J.C., 2006. Performance evaluation of photovoltaic thermal solar air collector for composite climate of India. *Sol. Energy Mater. Sol. Cells* 90, 175–189. <https://doi.org/10.1016/j.solmat.2005.03.002>

Tiwari, S., Agrawal, S., Tiwari, G.N., 2018. PVT air collector integrated greenhouse dryers. *Renew. Sustain. Energy Rev.* 90, 142–159. <https://doi.org/10.1016/j.rser.2018.03.043>

Tiwari, S., Tiwari, G.N., Al-Helal, I.M., 2016. Performance analysis of photovoltaic-

- thermal (PVT) mixed mode greenhouse solar dryer. *Sol. Energy* 133, 421–428.
<https://doi.org/10.1016/j.solener.2016.04.033>
- Tonui, J.K., Tripanagnostopoulos, Y., 2008. Performance improvement of PV/T solar collectors with natural air flow operation. *Sol. Energy* 82, 1–12.
<https://doi.org/10.1016/j.solener.2007.06.004>
- Tonui, J.K., Tripanagnostopoulos, Y., 2007a. Improved PV/T solar collectors with heat extraction by forced or natural air circulation. *Renew. Energy* 32, 623–637.
<https://doi.org/10.1016/j.renene.2006.03.006>
- Tonui, J.K., Tripanagnostopoulos, Y., 2007b. Air-cooled PV/T solar collectors with low cost performance improvements. *Sol. Energy* 81, 498–511.
<https://doi.org/10.1016/j.solener.2006.08.002>
- Touafek, K., Haddadi, M., Malek, A., 2013. Design and modeling of a photovoltaic thermal collector for domestic air heating and electricity production. *Energy Build.* 59, 21–28. <https://doi.org/10.1016/j.enbuild.2012.10.037>
- Tripanagnostopoulos, Y., 2007. Aspects and improvements of hybrid photovoltaic/thermal solar energy systems. *Sol. Energy* 81, 1117–1131.
<https://doi.org/10.1016/j.solener.2007.04.002>
- Vaishak, S., Bhale, P. V., 2019. Photovoltaic/thermal-solar assisted heat pump system: Current status and future prospects. *Sol. Energy* 189, 268–284.
<https://doi.org/10.1016/j.solener.2019.07.051>
- Vokas, G., Christandonis, N., Skittides, F., 2006. Hybrid photovoltaic-thermal systems for domestic heating and cooling-A theoretical approach. *Sol. Energy* 80, 607–615.
<https://doi.org/10.1016/j.solener.2005.03.011>
- Yang, T., Athienitis, A.K., 2015. Experimental investigation of a two-inlet air-based building integrated photovoltaic/thermal (BIPV/T) system. *Appl. Energy* 159, 70–79. <https://doi.org/10.1016/j.apenergy.2015.08.048>
- Yang, T., Athienitis, A.K., 2014. A study of design options for a building integrated photovoltaic/thermal (BIPV/T) system with glazed air collector and multiple inlets. *Sol. Energy* 104, 82–92. <https://doi.org/10.1016/j.solener.2014.01.049>
- Yazdanifard, F., Ameri, M., 2018. Exergetic advancement of photovoltaic/thermal systems (PV/T): A review. *Renew. Sustain. Energy Rev.* 97, 529–553.

<https://doi.org/10.1016/j.rser.2018.08.053>

- Younger, P.R., Kreisman, W.S., Nowlan, M.J., Solomon, S.J., Strong, S.J., 1981. Combination photovoltaic/thermal solar collectors for residential applications, in: Photovoltaic Specialists Conference, 15th, Kissimmee, FL, May 12-15, 1981, Conference. pp. 959–963.
- Yu, J.S., Kim, J.H., Kim, J.T., 2019. A study on the thermal performance of air-type BIPVT collectors applied to demonstration building. *Energies* 12. <https://doi.org/10.3390/en12163120>
- Yu, Y., Yang, H., Peng, J., Long, E., 2019. Performance comparisons of two flat-plate photovoltaic thermal collectors with different channel configurations. *Energy* 175, 300–308. <https://doi.org/10.1016/j.energy.2019.03.054>
- Zhang, X., Zhao, X., Smith, S., Xu, J., Yu, X., 2012. Review of R&D progress and practical application of the solar photovoltaic/thermal (PV/T) technologies. *Renew. Sustain. Energy Rev.* 16, 599–617. <https://doi.org/10.1016/j.rser.2011.08.026>
- Zondag, H.A., 2008. Flat-plate PV-Thermal collectors and systems: A review. *Renew. Sustain. Energy Rev.* 12, 891–959. <https://doi.org/10.1016/j.rser.2005.12.012>