



**HAL**  
open science

## A polarity dependent spark-gap operated as a very high voltage diode

Bucur Mircea Novac, Ivor Smith, Michael Parker, Peter Senior, Laurent Pecastaing, Antoine Silvestre de Ferron, Pascal Pignolet, Sonia Souakri, Gerry Louverdis

### ► To cite this version:

Bucur Mircea Novac, Ivor Smith, Michael Parker, Peter Senior, Laurent Pecastaing, et al.. A polarity dependent spark-gap operated as a very high voltage diode. IEEE International Pulsed Power Conference, Jun 2013, San Fransisco, United States. pp.1-6, 10.1109/PPC.2013.6627458 . hal-04299279

**HAL Id: hal-04299279**

**<https://univ-pau.hal.science/hal-04299279>**

Submitted on 25 Apr 2024

**HAL** is a multi-disciplinary open access archive for the deposit and dissemination of scientific research documents, whether they are published or not. The documents may come from teaching and research institutions in France or abroad, or from public or private research centers.

L'archive ouverte pluridisciplinaire **HAL**, est destinée au dépôt et à la diffusion de documents scientifiques de niveau recherche, publiés ou non, émanant des établissements d'enseignement et de recherche français ou étrangers, des laboratoires publics ou privés.

# A POLARITY-DEPENDENT SPARK-GAP OPERATED AS A VERY HIGH-POWER DIODE\*

**B. M. Novac<sup>‡</sup>, I.R. Smith, M. Parker, P. Senior**

*School of Electronic, Electrical and Systems Engineering, Loughborough University,  
Loughborough, Leicestershire LE11 3TU, UK*

**L. Pecastaing, A. De Ferron, P. Pignolet, S. Souakri**

*Université de Pau, SIAME, Hélioparc, F-64000 Pau, France*

**G. Louverdis**

*Dstl, Fort Halstead, Kent TN 14 7BP, UK*

## *Abstract*

A high-power, high-energy pulsed-power generator, based on a 415 kJ / 22 kV capacitor bank, has recently been developed at Loughborough University [1]. The generator can drive a high-impedance system, generating a total electrical power of many GW, while depositing a Joule energy of many tens of kJ in the load. To remove the unwanted negative-polarity voltage precursor and at the same time sharpen the output, the arrangement requires the use of a high-power ‘diode’ in the transformer secondary winding circuit.

The paper describes the successful development of a polarity-dependent spark-gap which can be used as a high-voltage high-power diode. Operated in air at atmospheric pressure, the unit is capable of removing unwanted negative polarity voltage impulse precursors up to -300 kV, while at the same time capable of closing at +140 kV, thus reducing the rise time of the positive polarity voltage impulse down to about two microseconds.

After a short description of the high-power, high-energy pulsed power system, the design of the high-power diode is outlined. Using an electrostatic simulation of the special electrode configuration, an explanation is provided for the polarity-dependent breakdown phenomena. Preliminary experimental tests, using the Pau University Marx generators to confirm the diode effect, are also presented

Finally, high-energy high-power tests using the generator are briefly presented, highlighting the impeccable functioning of the high-power diode.

## **I. INTRODUCTION**

An ongoing experimental program at Loughborough requires the supply of a few GWs of power to a high-

impedance system. This unusual load requires the careful design of a matching high-energy high-power source.

The entire high-energy, high-power system was accommodated in a metallic container as a transportable autonomous pulsed power facility [1]. More recently, a novel design of a very robust coaxial air-core pulsed transformer, capable of safe repetitive operation at well above the present load currents was developed, together with a matching closing switch capable of operating as a high-power HV diode.

The present paper is focused on describing the design and testing of the HV diode. Firstly, a 3-D electrostatic simulation using CST EM Studio is presented and this is followed by a series of experimental results obtained during preliminary testing of the HV diode.

The paper ends by briefly presenting a typical result obtained when the HV diode was incorporated in the high-energy high-power system.

## **II. HIGH-ENERGY HIGH POWER GENERATOR**

The generator is fully described in an accompanying paper [2] and therefore only a brief outline is provided here. The generator is based on an inductive storage design, with the equivalent electrical scheme shown in Fig. 1, and contains in the primary winding circuit an opening switch  $S_1$  based on an exploding wire array (EWA), a high-Coulomb closing switch and the single-turn primary winding of the high-voltage transformer (HVT). The load is connected to the secondary winding of the transformer through a high-voltage spark gap  $S_2$ , immediately prior to the moment that the voltage developed across the EWA reaches its peak value.

The switch must therefore act as a diode, removing the unwanted negative voltage precursor generated before the EWA begin to function, and connecting the load only

\* The work was carried out as part of a UK Dstl (MoD) Research Programme

<sup>‡</sup> email: B.M.Novac@lboro.ac.uk

when the positive voltage generated by EWA action begins to build-up. As a bonus, the action of the  $S_2$  switch also conditions the output (load) current, by reducing its rise time.

The generator is described by the following set of components:

- a capacitor bank comprising 8 capacitors type GAEP 32349, each having a capacitance  $C = 206 \mu\text{F}$  and charged up to  $V_0 = 20 \text{ kV}$  using a charger type GAEP CCS08020P1D able to supply 8 kJ/s;
- an EWA made from 20 copper wires each 500  $\mu\text{m}$  in diameter and 500 mm long;

The total self-inductance and resistance of the primary circuit (excluding the transformer primary winding) are  $L = 100 \text{ nH}$  and  $R = 10 \text{ m}\Omega$ . These figures include the contribution from the detonator-activated closing switch  $S_1$  of only 0.5 nH and less than 0.5 m $\Omega$ . The mock-up load used as equivalent of the system to be driven has both a high value of self-inductance and resistance. As mentioned above, apart from the HV diode, the components are fully described in [1] and in the accompanying paper [2].

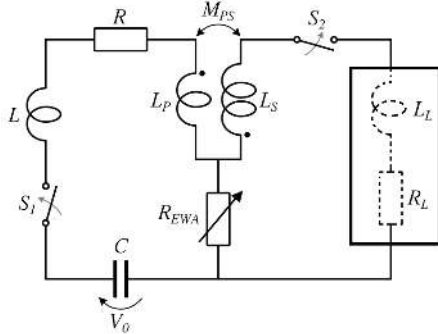

**Figure 1.** Equivalent electrical scheme of the inductive-storage high-energy pulsed power generator.

### III. THE HV DIODE

#### A. The role of the HV diode

If the secondary winding circuit does not contain any switch and is simply closed at the beginning of the bank discharge, an  $\text{emf} = -M_{PS} dI_p / dt$  is generated (where  $dI_p/dt > 0$  represents the time rate-of-change of the primary winding circuit current and  $M_{PS}$  is defined in Fig. 1), driving the load with a negative voltage. At the moment the EWA opens, the current falls very fast, with  $dI_p/dt \ll 0$  and  $\text{emf} > 0$ , and the load voltage becomes positive. Without a switch in the secondary winding circuit, the load voltage is therefore bi-polar. If however a HV diode is made using a closing switch, this switch must firstly withstand (i.e., remain open) during the time the negative voltage impulse is generated and only after the EWA opens must it close at a relatively low positive voltage, coupling the load to the transformer secondary winding circuit. The closure at a relatively low positive voltage is required for optimizing the load current rise time.

The aim during the design and preliminary tests was to ensure that the switch can withstand a high negative voltage of say -300 kV and at the same time easily close around +140 kV. With the HV diode operating in this way the first negative part of the load voltage, termed the 'precursor', is completely removed i.e., during this time the load remains disconnected. Only when the EWA opens (i.e., explodes) and the voltage across the switch  $S_2$  becomes positive, will the diode conduct, attaching the load at a positive voltage allowing a fast rising load impulse and therefore performing conditioning.

Preliminary tests were undertaken at Pau in order to determine the optimum geometrical configuration for the HV diode, using similar temporal characteristics of the loading voltage to those generated when the HV diode functions as part of the high-energy high-power generator.

#### B. Preliminary test arrangement

To determine if a polarity-dependent spark-gap can be developed, the arrangement presented on Fig. 2(a) was used. The HV diode consists basically of a rod/plate geometry operated in ambient air, with a metal plate positioned above the rod. The rod is connected to a Marx generator via a long thick copper sheet (see Fig.2(b)), while a low-inductance transmission line, comprising four parallel-connected cables, couples the metallic plate to the laboratory ground.

The metal plate is maintained in position by a stack of commercially available disc isolators suspended from a gantry. The rod is simply placed on a table and a thick plastic foil used for electric insulation. The distance 'd' between the metal plate and the rod can be adjusted between 100 mm and 400 mm.

#### C. Test generators and diagnostics

Three Marx generators were used to apply various high voltage waveforms to the HV diode. The first (shown in Fig. 3(a)) is a ten stage Marx generator (1 MV, 17 kJ) and was used to generate an impulse with a 3  $\mu\text{s}$  rise time and a width of 3,500  $\mu\text{s}$ . The second generator (shown in Fig. 3(b)) has 20 stages with 20 kV per stage, (with a total stored energy of 8 J) and generated a maximum peak voltage of 400 kV, having a rise time of 30 ns and an impulse width of 10  $\mu\text{s}$ . The final waveform used during testing was generated by a third generator (shown in Fig. 3(c)) which has a maximum peak voltage of about 400 kV (with a total stored energy of 16 J) with a rise time 1.2  $\mu\text{s}$  and a characteristic time decay of 80  $\mu\text{s}$ .

The following voltage sensors were used during the HV diode studies:

- a HV NORTHSTAR VD300 voltage divider (12 MHz, 20 pF, attenuation ratio 1/10,000) capable of measuring voltage impulses with a peak of about 400kV
- a unit composed of a HV probe NORTHSTAR PVM3 (40 MHz, 10 pF) connected at the output of a homemade capacitive divider (10 MHz, 40 pF, 1 MV), with an overall attenuation ratio of 1/24,500.

The outputs of the two voltage probes were fed to a TEKTRONIX oscilloscope type TDS680C (1 GHz, 5 GS/s).

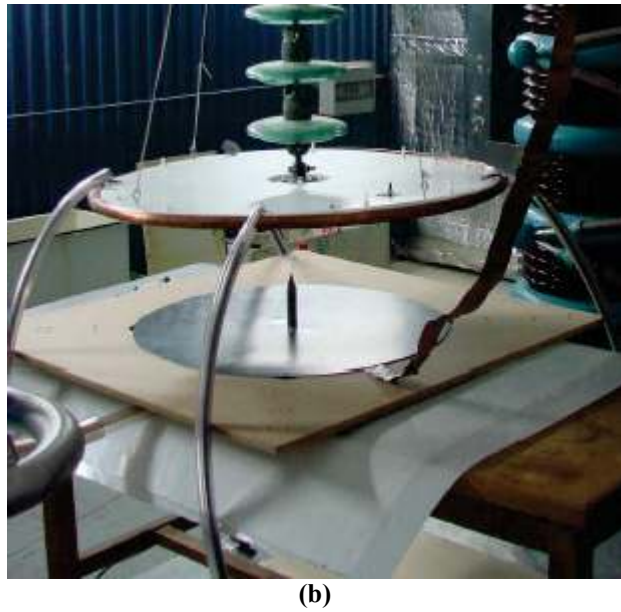
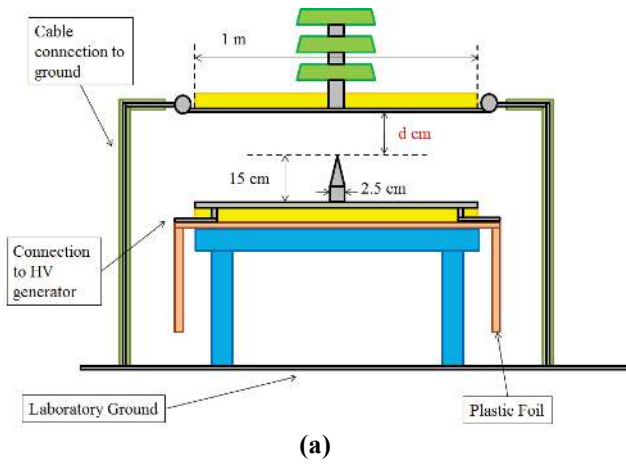

**Figure 2.** (a) Experimental setup scheme and (b) photograph

#### D. Experimental results during preliminary testing

For the design of the HV diode, various experimental tests were performed with the aim of determining the gap distance ‘d’ which allows the switch to withstand -300 kV and to close at +140 kV. Due to space restrictions, only the essential results are presented below.

In figure 4(a), when a negative voltage pulse is applied by the Marx generator shown in Fig. 3(a), breakdown occurs at a voltage -310 kV for a gap distance of  $d_n = 200$  mm.

In figure 4(b), using the Marx generator shown in the figure 3(c) and for  $d_p = 130$  mm, the breakdown is recorded at +140 kV.

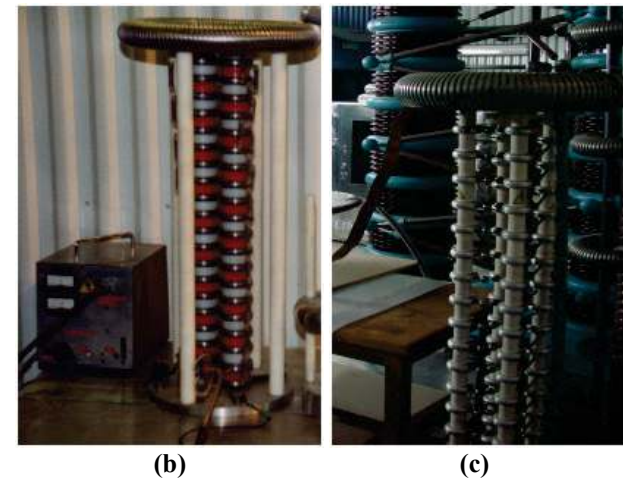
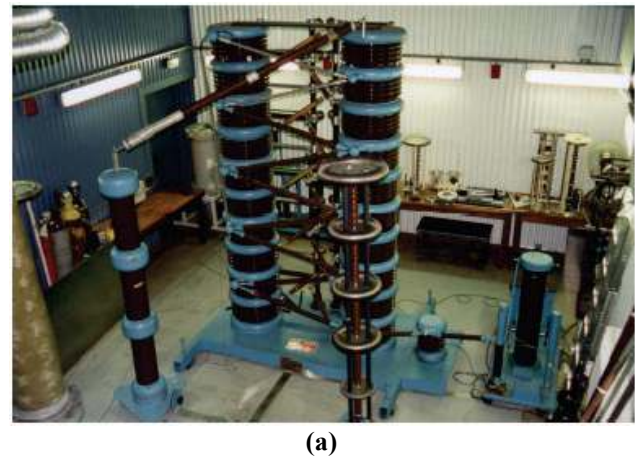

**Figure 3.** Marx generators used during preliminary testing: (a) 1 MV / 17 kJ (b) 400 kV / 8 J (c) 400 kV / 16 J

#### E. 3D electrostatic simulations

A CST EM Studio 3-D electrostatic solver was used to provide a better understanding of the functioning of the HV diode. This software package includes various solver modules that are ideally suited to the analysis of static and low frequency devices.

Both experimental conditions presented in part D were simulated, by applying a static high-voltage on the rod of -310kV and +140kV respectively. Fig. 5 presents both 2-D and 3-D views of the electric field distribution for negative polarity. Figs.6 and 7 show the voltage evolution and the electric field distribution along the vertical Oz axis of the arrangement, from the rod to the metal plate. The tip of the rod corresponds to the origin  $z = 0$  mm while the plate is either situated at  $z = d_n = 200$  mm for the negative polarity test or  $z = d_p = 130$  mm for the positive polarity test.

The results show that the electric field generated in the immediate vicinity of the rod is very strong i.e., 280 kV/cm for negative polarity and 80 kV/cm for positive polarity, and decreases exponentially towards the metal plate, where it is only 9 kV/cm for negative polarity and 5.7 kV/cm for positive polarity.

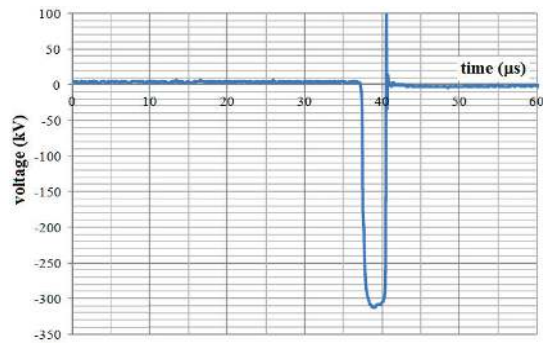

(a)

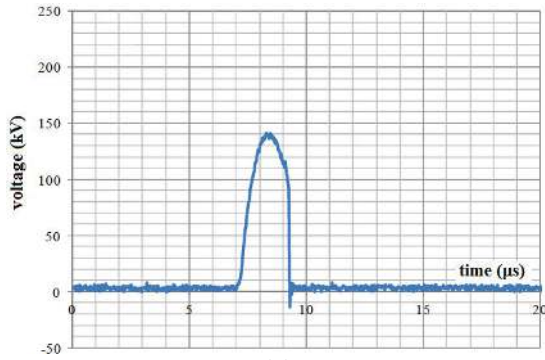

(b)

**Figure 4.** Results from testing the HV diode (a) closure at -310 kV and (b) closure at +140 kV

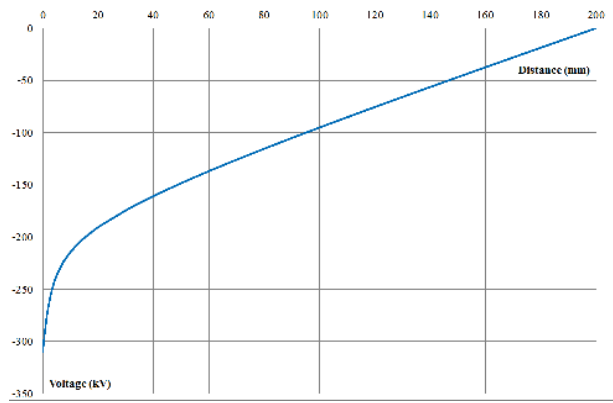

(a)

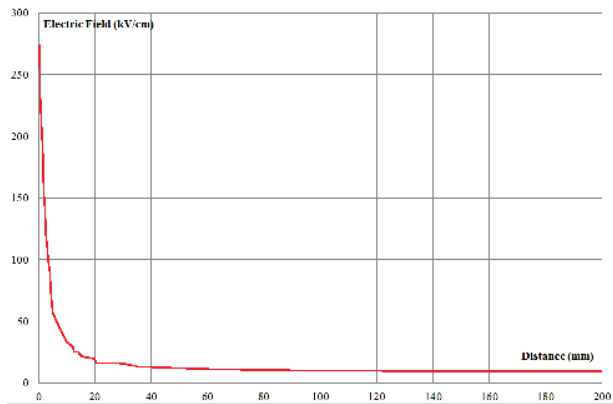

(b)

**Figure 6.** Results from 3-D electrostatic simulations of the HV diode for negative polarity ( $d_n=200$  mm)

(a) voltage and (b) electric field distribution along the axis as a function of the distance

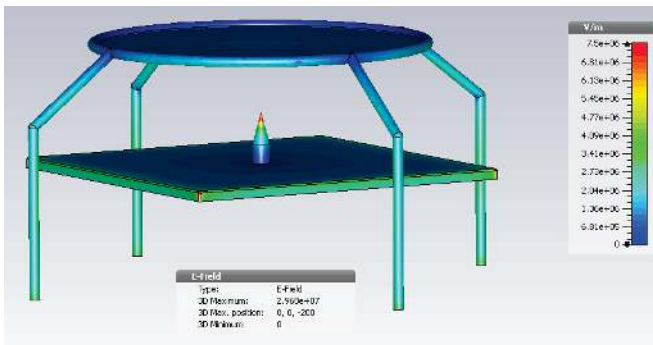

(a)

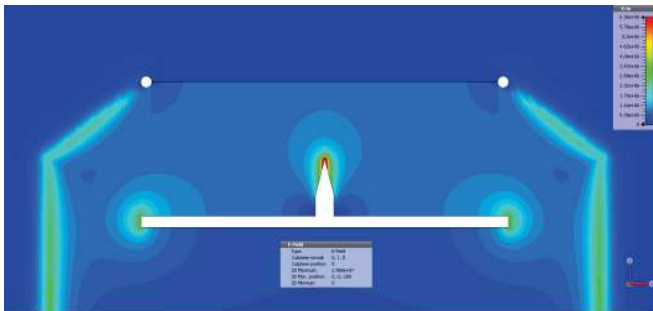

(b)

**Figure 5.** Electric field distribution in negative polarity For an applied voltage of -310 kV (a) 3-D view and (b) 2-D representation

### F. Analysis

To initiate the electrical discharge, the first condition is related to the electrical field intensity in the immediate vicinity of the rod. In air, the breakdown value in a homogeneous field under DC conditions is estimated as 30 kV/cm/bar [3, 4]. The value under pulsed conditions is always greater than the reduced field in DC conditions [5]. It is well-known that the voltage which can be applied to a spark gap without breakdown can be 2-3 times greater than that under DC charging. The value of the overvoltage is a function of the nature of the gas, gap spacing, polarity and rise-time of the voltage impulse. This phenomenon is attributed to the delay introduced (i.e., statistical time-lag) while waiting for a seed electron to appear [6, 7]. In the present test conditions, the aim is to have the conditions leading to a breakdown during the rise of the transformer voltage output in positive polarity. Under these conditions, the time allowed to find seed electrons is short (a few  $\mu$ s) and therefore the stability and the reproducibility of the load output pulse is very much improved.



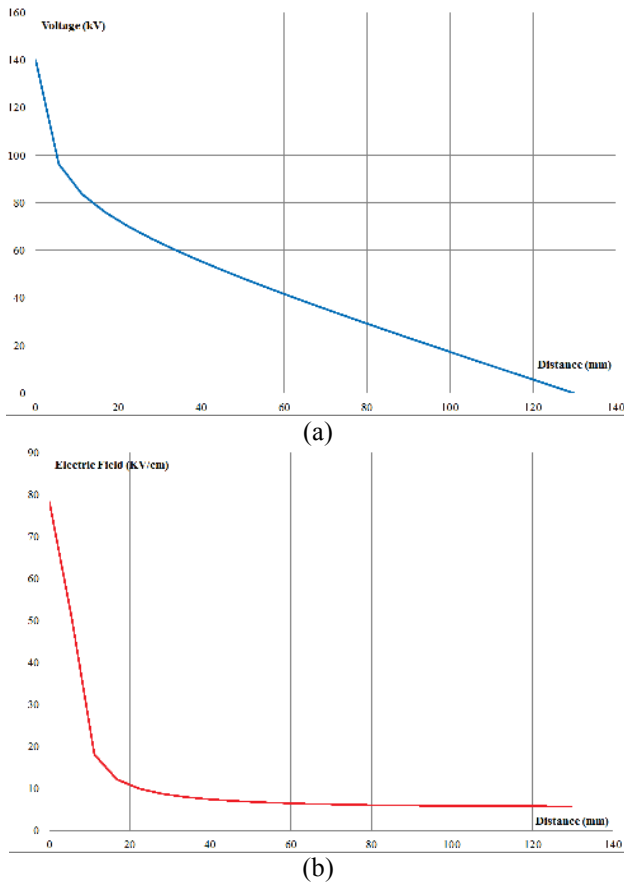

**Figure 7.** Results from 3D electrostatic simulations of the HV diode for positive polarity ( $d_p=130$  mm)  
 (a) Voltage and (b) electric field as a function of the distance

Moreover, it is well known that the level of the overvoltage obtained increases as the pulse rise-time reduces [6]. Thus, it should be possible, by applying a fast rising pulse to a spark-gap to achieve significant overvoltage and subsequent ionisation, leading to the rapid collapse of the channel.

The second important mechanism to ensure the propagation of a breakdown is attributed to the discharge propagation. In air, positive streamers are described by a model that considers the head of the streamer as a sphere with concentrated positive charges [8, 9]. The propagation of the streamer is completely determined by the energy balance at the head. As a consequence, there is a propagated electric field in which the streamer can continue to grow without losing or gaining charges. The values of this field are 5 kV/cm/bar for positive polarity and 18 kV/cm/bar for negative polarity, which can explain the polarity dependence of the breakdown for the present HV diode.

The molecular binding forces in air are sufficiently low to consider the negative space charge behind the streamer sufficiently away so that the assumption of a unipolar space charge is justified. Thus, the contribution

of the space charge field in the streamer propagation in air is decisive. The space charge field could be taken into account by a microscopic model, but this is beyond the scope of the present study.

The spatial distributions of the electric field presented in Figs. 6(b) and 7(b) are sufficient to provide an understanding of the breakdown phenomenon.

As already mentioned, for positive polarity, the electric field in the immediate vicinity of the rod reaches 80 kV/cm. This value is greater than the critical reduced field in air (30 kV/cm) because of the pulse conditions and the discharge can be initiated. After this, the electric field remains above the propagation field of the streamers in air i.e., about 5 kV/cm for this polarity, which is why a breakdown occurs.

For negative polarity, at -310 kV, the electric field in the vicinity of the rod is very strong and allows maintaining the electric field along the axis to a value sufficiently high to initiate a breakdown.

#### IV. RESULTS WITH THE COMPLETE HIGH-ENERGY HIGH-POWER GENERATOR

The high-energy, high-power generator output is inherently bi-polar, producing a negative voltage during magnetisation of the primary winding, and a positive voltage during the collapse of the magnetic field once the current is interrupted by the exploding wires.

The system to be driven can be connected either directly to the generator (blue trace on Fig. 8), or via the high-voltage diode (with  $d = 180$  mm) for which the negative precursor is removed and the rise time is improved (red curve on Fig. 8).

Due to the polarity dependent spark-gap, the load current also shows no negative precursor and is conditioned to a rather short rise time (see Fig. 9). Moreover, both simulations and experiments show that the peak of the positive load voltage impulse is increased by the HV diode action.

Finally, Fig. 10 presents stills from a movie with 1000 frames/s, showing the diode plasma dynamics during a high energy shot of the complete device.

#### V. CONCLUSION

A novel HV diode, based on polarity-dependent pin-plane closing switch geometry and operated in ambient air was recently designed constructed and successfully tested using Marx generators. The HV diode can withstand a negative voltage impulse of up to -300 kV and close when a positive voltage of only +140 kV is applied.

The paper outlines the design of the high-power diode and preliminary tests are described proving the diode effect is indeed presented. Using an electrostatic simulation of the design configuration based on the CST

## VI. REFERENCES

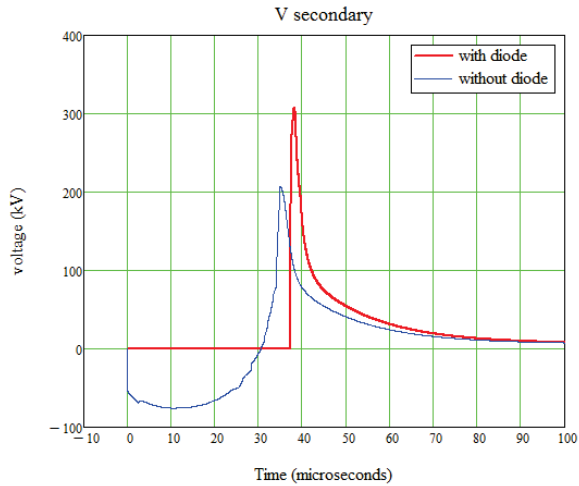

**Figure 8.** Time variation of the load voltage: without HV diode (blue trace) and with HV diode (red trace)

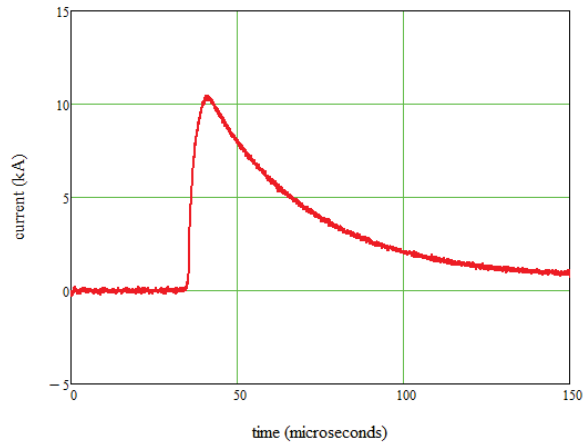

**Figure 9.** Typical shape of the load current with HV diode present in the secondary winding circuit



**Figure 10.** Dynamics of diode plasma during a high energy shot (stills from a 1000 fps movie)

EM Studio, an explanation was provided for the polarity-dependent breakdown phenomena.

Finally, the great advantages of the HV diode to withstand a large negative high-voltage precursor and to close at a rather low positive pulse, thus performing a very effective load current conditioning, were both demonstrated on the high-energy, high-power system.

[1] B.M. Novac, M. Parker, I.R. Smith, P. Senior and G. Louverdis, “A Mobile, High-Power, High-Energy Pulsed-Power System”, *Proc. IEEE International Power Modulator and High Voltage Conference*, San Diego, 2012, to be published

[2] B.M. Novac et al., ‘Coaxial 0.5 MV Air-core Pulse Transformer’, *these Proceedings, paper 9E-1*

[3] L. Pecastaing, T. Reess, P. Espel, J. Paillol, A. Gibert, P. Domens, “Investigation of breakdown characteristics of N<sub>2</sub>, SF<sub>6</sub> and N<sub>2</sub>-SF<sub>6</sub> mixtures under pressure”, *Proc. 11<sup>th</sup> International Symposium on High Voltage Engineering (ISH)*, Vol 3, pp 224-227, London, 1999

[4] L. Pecastaing, T. Reess, J. Paillol, A. Gibert, P. Domens, “Electrical breakdown studies of pressurised N<sub>2</sub> in non uniform fields”, *European Journal of Physics*, Vol 16, pp 59-69, 2001

[5] L. Pecastaing, J. Paillol, T. Reess, A. Gibert, P. Domens, “Design and performance of high voltage pulse generators for ultra-wideband applications”, *Measurement Science and Technology*, vol. 12, p 1718-1725, 2001

[6] A. Gibert, J. Dupuy, P. Domens, G. Riquel, B. Hutzler., “Dielectric behaviour of SF<sub>6</sub> in non-uniform fields”, *J. Phys. D: Appl. Phys.* 26, p 773-781, 1993

[7] L. Pecastaing, A. Gibert, P. Bayle, “Time lag of neutral depopulation of various gases in a point-plane discharge”, *Proc. 12<sup>th</sup> International Symposium on High Voltage Engineering (ISH)*, Volume 1, n°4-2, Bangalore (Inde), 2001

[8] I. Gallimberti, “A computer model for streamer propagation”, *J. Phys D: Applied Physics*, Volume 5, pp. 2179-2189, 1972

[9] I. Gallimberti, N. Wiegart, “Streamer and leader formation in SF<sub>6</sub> and SF<sub>6</sub> mixtures under impulse conditions”, *J. Phys D: Applied Physics*, Volume 12, pp. 2351-2379, 1986