



HAL
open science

Cold Atmospheric Plasmas in interactions with materials and liquids for biological applications

Franck Clement, Bernard Held, Kristacq Gazeli, Laurent Marlin, Erwan Morel, Fanny Girard-Sahun, Sylvie Blanc, Bruno Grassl, Stephanie Reynaud, Pierre Marcasuzaa, et al.

► **To cite this version:**

Franck Clement, Bernard Held, Kristacq Gazeli, Laurent Marlin, Erwan Morel, et al.. Cold Atmospheric Plasmas in interactions with materials and liquids for biological applications. 7 th International Symposium on Surfaces and Interfaces of Biomaterials, Jul 2019, Québec, Canada. hal-02191333

HAL Id: hal-02191333

<https://univ-pau.hal.science/hal-02191333>

Submitted on 24 Aug 2023

HAL is a multi-disciplinary open access archive for the deposit and dissemination of scientific research documents, whether they are published or not. The documents may come from teaching and research institutions in France or abroad, or from public or private research centers.

L'archive ouverte pluridisciplinaire **HAL**, est destinée au dépôt et à la diffusion de documents scientifiques de niveau recherche, publiés ou non, émanant des établissements d'enseignement et de recherche français ou étrangers, des laboratoires publics ou privés.



Cold Atmospheric Plasmas in interactions with materials and liquids for biological applications

Franck Clément¹

franck.clement@univ-pau.fr

In collaboration with: B Held¹, K Gazeli¹, L Marlin¹, E Morel¹, F Girard¹, S Blanc¹, B Grassl¹, S Reynaud¹, P Marcasuzaa¹, C Veclin¹, I Lebouachera¹, F Léonardi¹, Q Hoqui¹, C Nardin¹, X Callies¹, S Arbault², V Badets², P Lefrançois², N Sojic²

¹ *Pau University – IPREM UPPA, France*

² *Univ. Bordeaux, ISM, CNRS UMR 5255, INP Bordeaux, 33400 Talence, France*



Tuesday, July 23, 2019, 11h50-12h30

Québec City Convention Centre
1000, boulevard René-Lévesque Est
Québec QC G1R 5T8
Canada



Univ Bordeaux, ENSCBP

Very nice environments



Wines libraries



UPPA – IPREM, Pau



béarnaise

Specialties: GARBURES \updownarrow

basque



UPPA – site Côte basque, Montauray

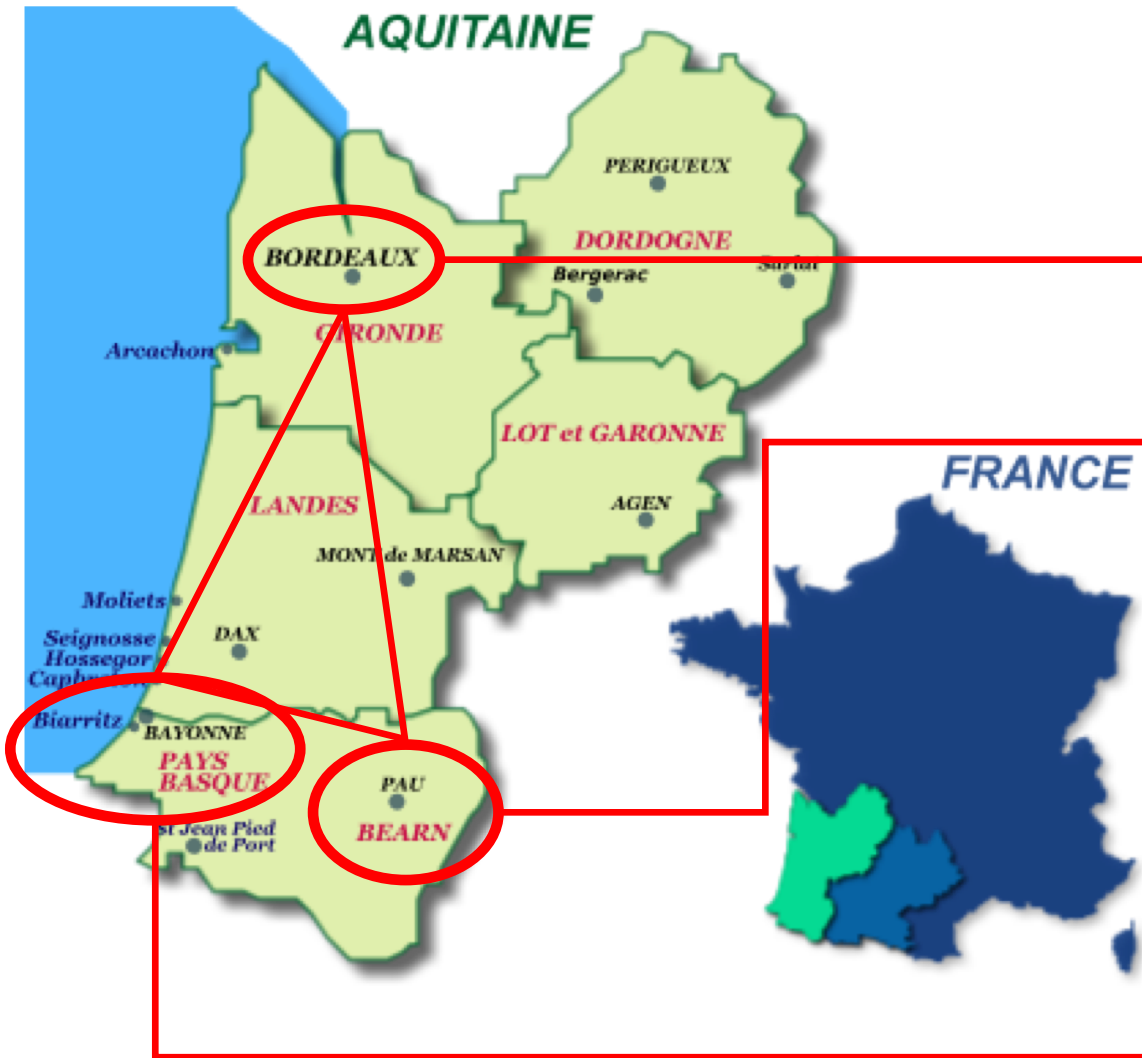

Why speaking about GARBURES ?



a bit like ...

Plasma Components:

- Neutral particles
- Electrons and Ions
- Electric fields
- Excited Particles: radiative and metastable, radicals, ROS, RNS
- Photons (UV, Visible, IR)

Because GARBURES contains **numerous energy components:** different vegetables (potatoes, pumpkin, leek, turnip, onion, tomato, ...) and different meat (pork, duck, ...)

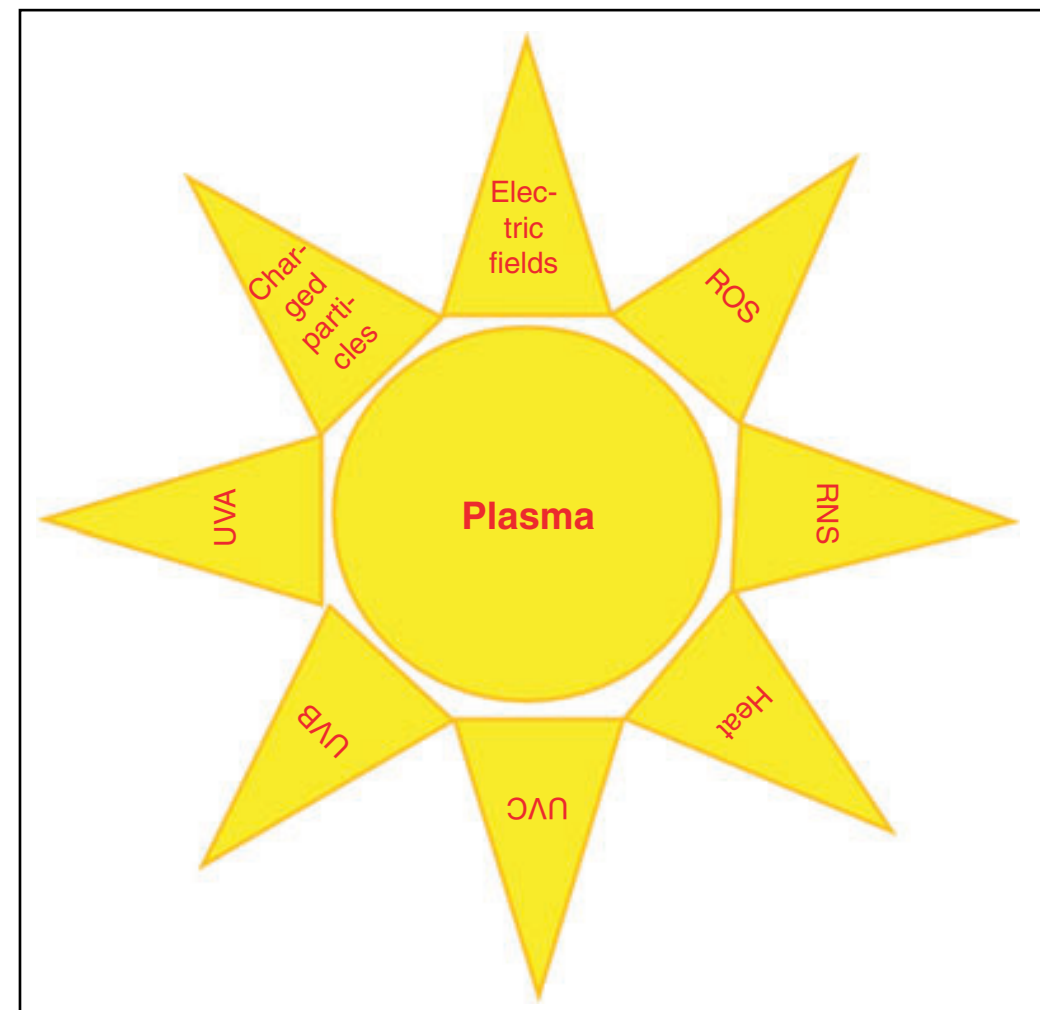

DEFINITION

COLD PLASMA = WEAKLY IONISED GAS

Produced by electrical discharges between two electrodes and by using specific HV power supply

By introducing a dielectric material between the electrodes, and by using pulsed HV power supplies, it is possible to generate cold plasmas at atmospheric pressure and temperatures closed to room temperature:

COLD ATMOSPHERIC PLASMAS (CAPs)

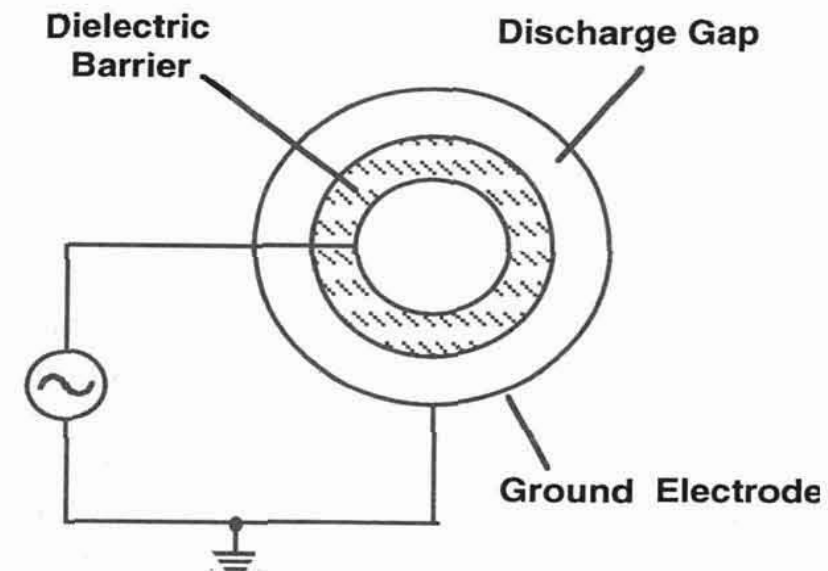
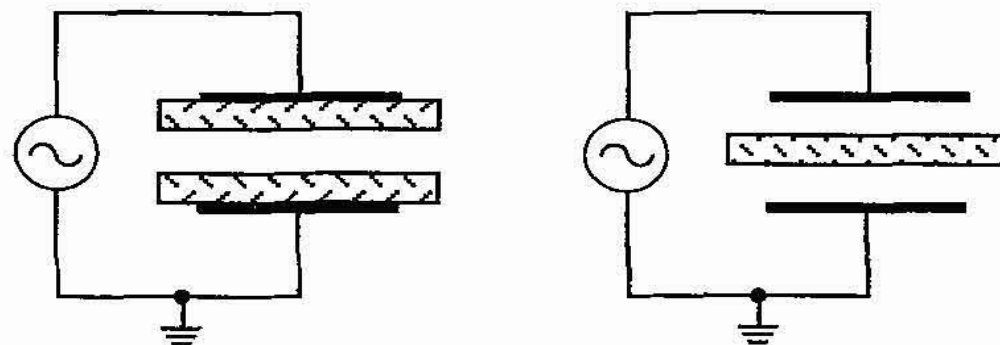
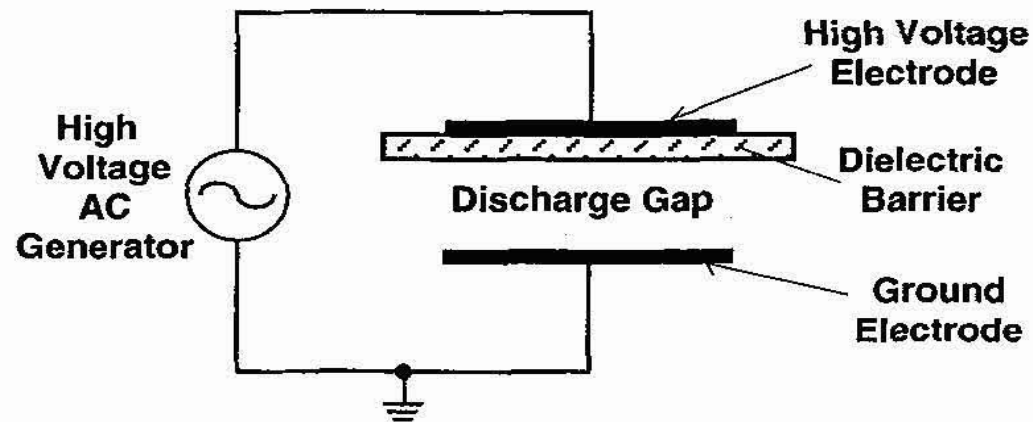
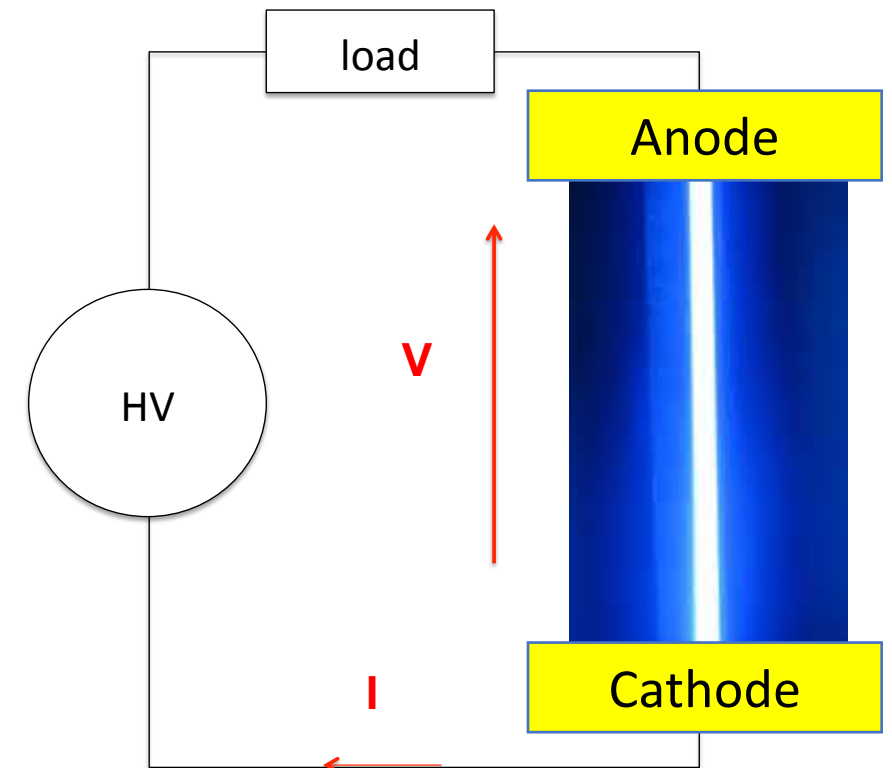

Mechanisms in electrical discharges

Townsend laws: Electronic avalanches in the gap

Ionisation : $A + e^- \Rightarrow A^+ + 2e^- \dots$

Examples of energy ionisation

Molécules	W_i (eV)
CO ₂	13,7
N ₂	15,5
O ₂	12,2
H ₂	15,4
H ₂ O	12,6

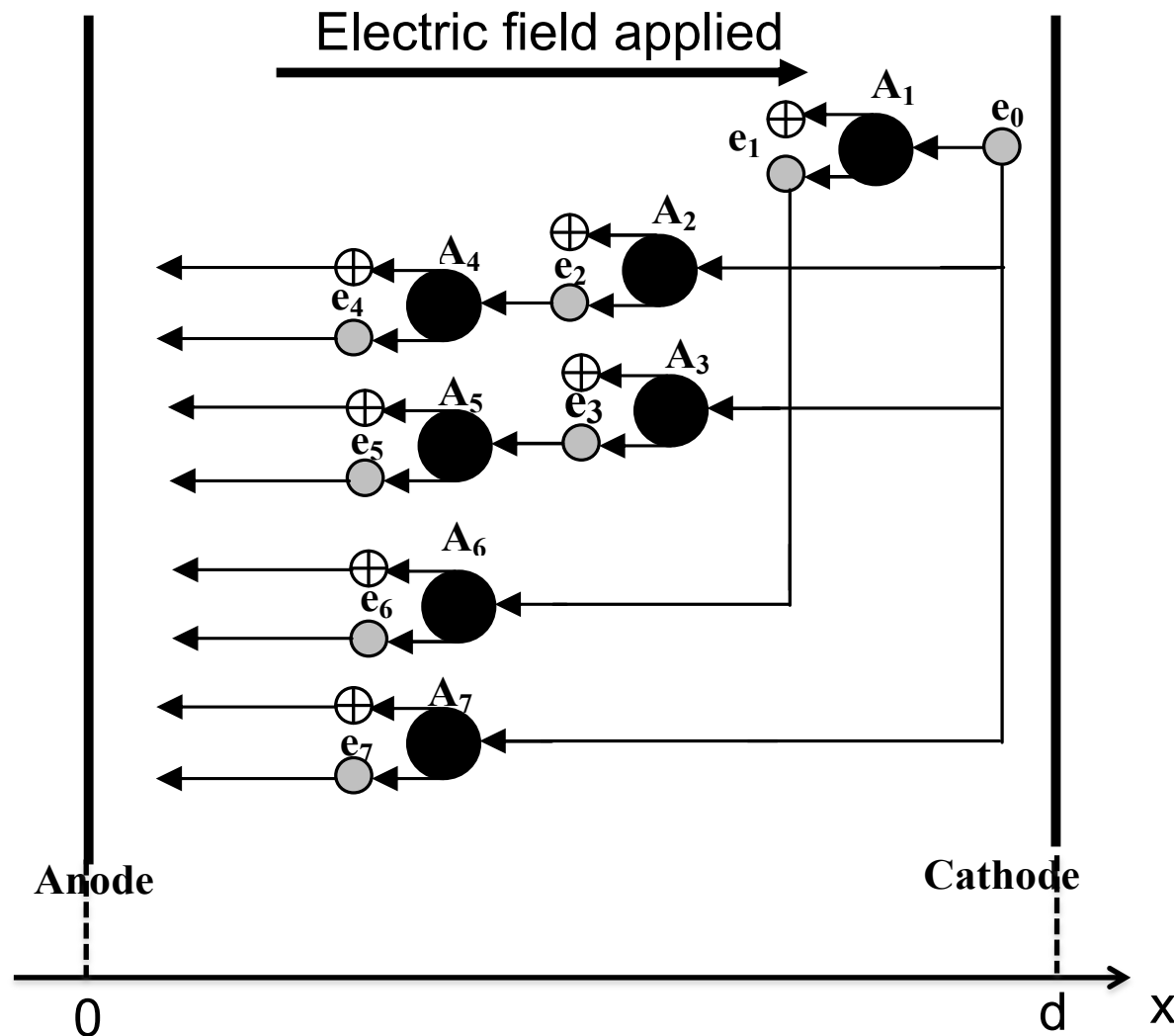

Two important coefficients depending on the nature of gases and electrodes used

- 1- Multiplication of charges in the gaseous volume characterized by electronic avalanches and defined by the first Townsend coefficient : α

$$n = n_0 \cdot \exp(\alpha x)$$

- 2- Multiplication of charges due to secondary emission at the cathode and defined by the second Townsend coefficient : γ

Mechanisms in electrical discharges

After the formation of electronic avalanches, and when the space charge field becomes greater than the applied electric field, the space charge field controls the discharge and its dynamics.

We thus obtain an **ionization wave**, which propagates itself due to the space charge field. This ionization wave is called a **STREAMER**

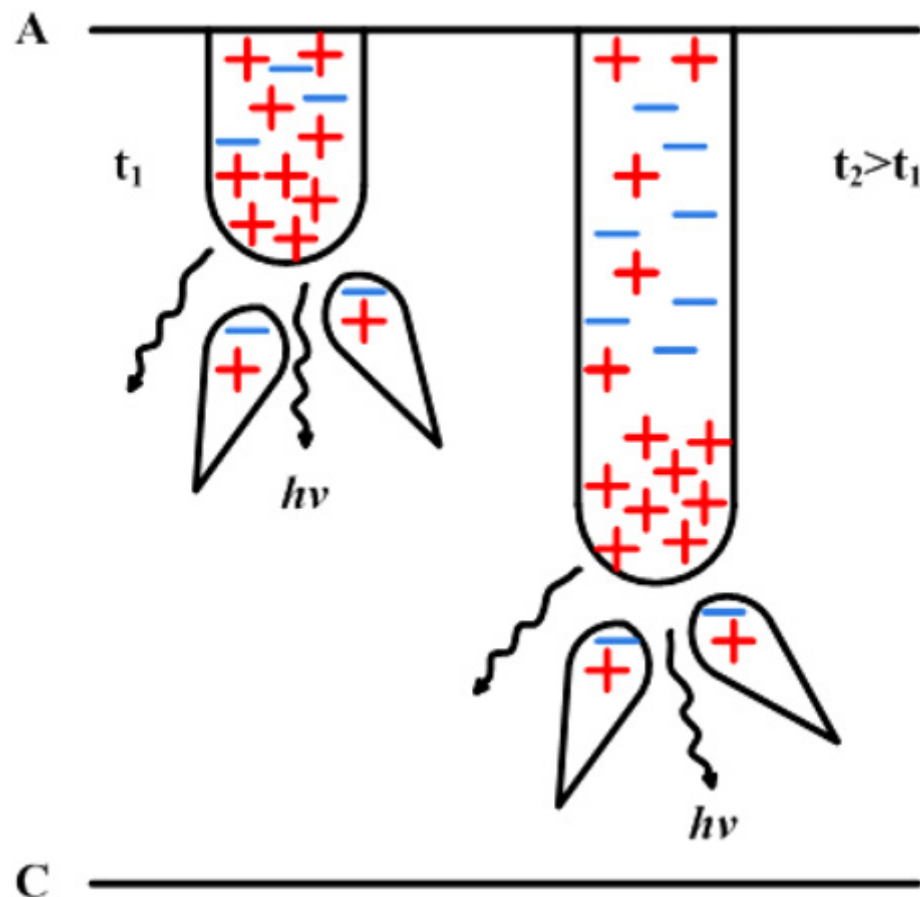

The propagation velocity of streamers is higher than electronic avalanche velocity

$$10^5 \text{ to } 10^8 \text{ cm.s}^{-1}$$

at atmospheric pressure

Electrons are hot in a cold plasma, allowing the production of numerous excited states

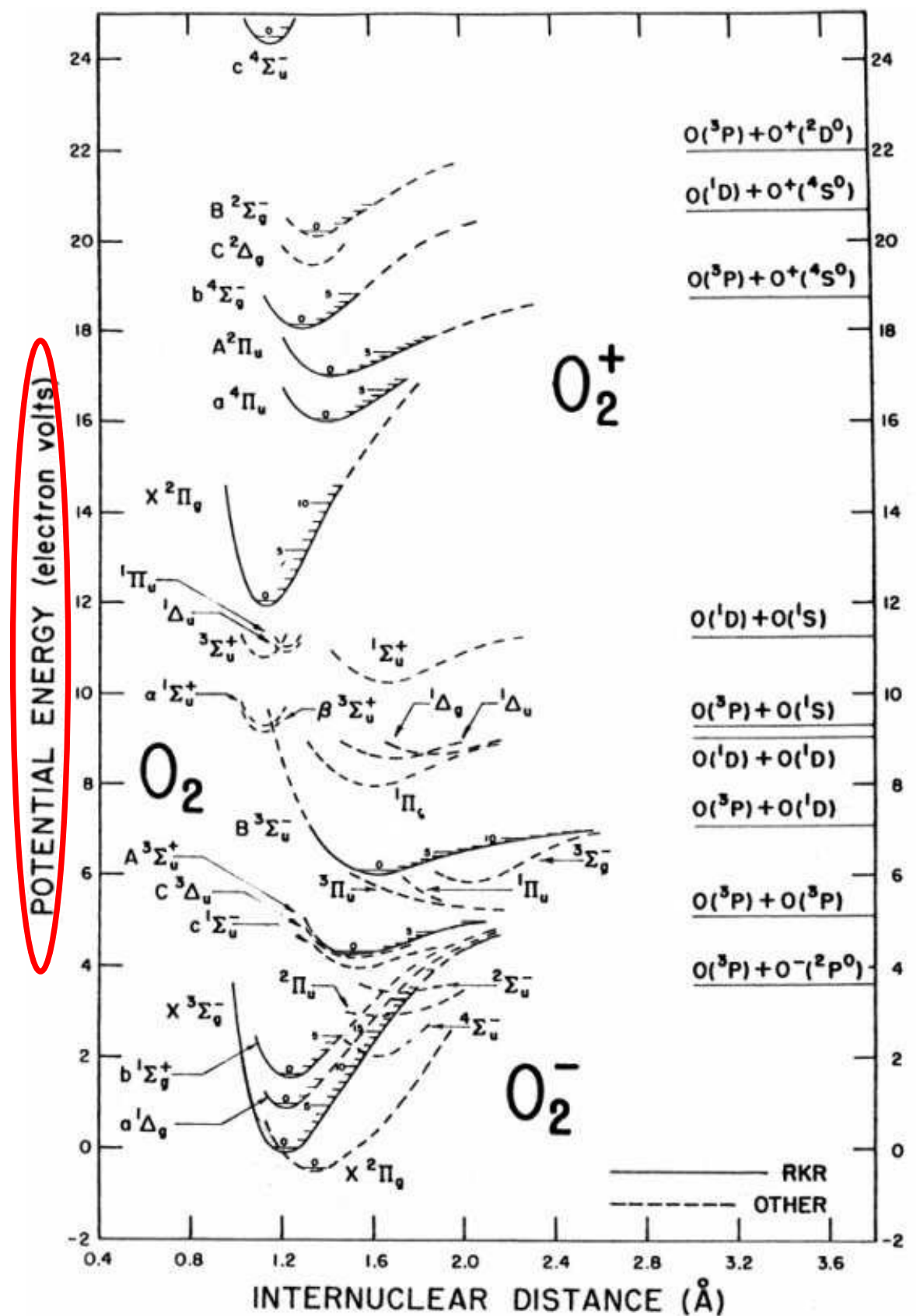
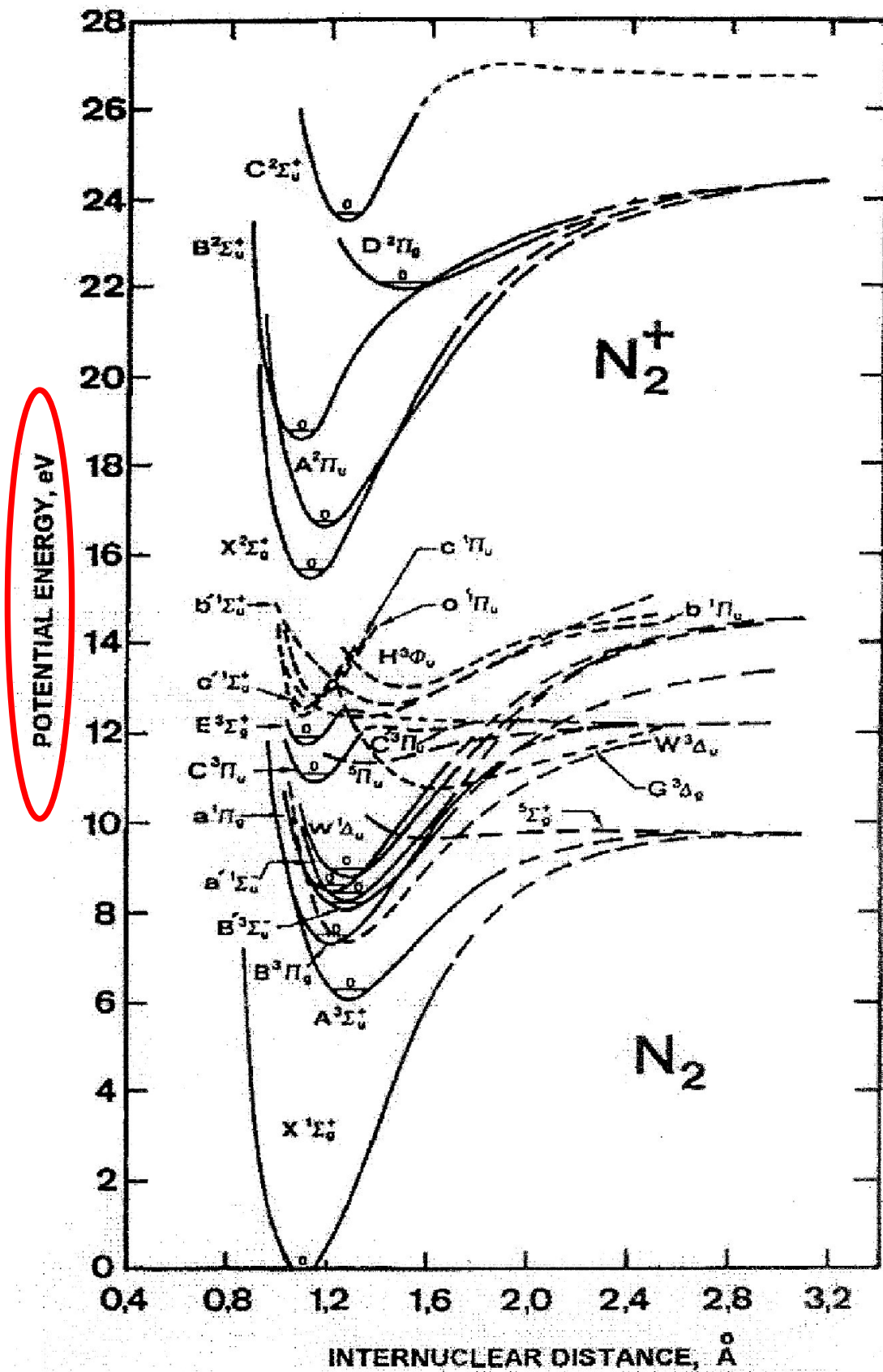

Potential energies and diagrams for N_2 and O_2

GUIDED IONIZATION WAVE

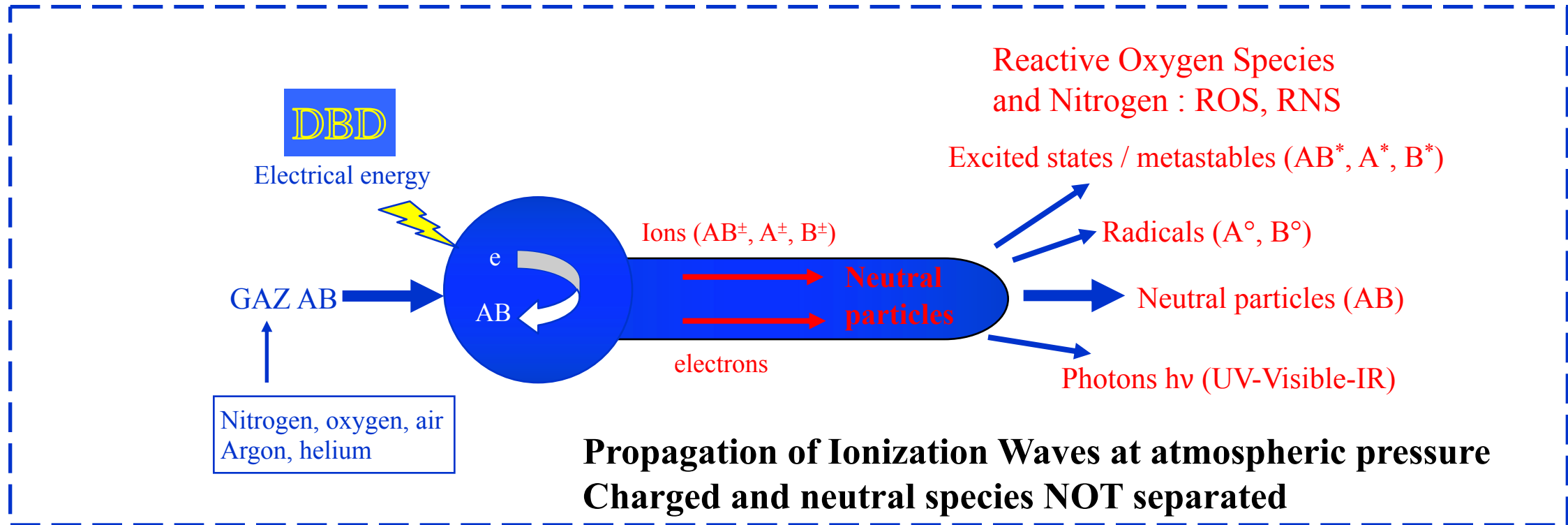

Gazeli, Clément et al., *Possibility of controlling the chemical pattern of He and Ar “guided streamers” by means of N₂ or O₂ additives*,
J. Appl. Phys. **117**, 093302 (2015)



Gazeli, Clément et al., *A study of helium atmospheric-pressure guided streamers for potential biological applications*,
Plasma Sources Sci. Technol. **22** (2013) 025020 (9pp)

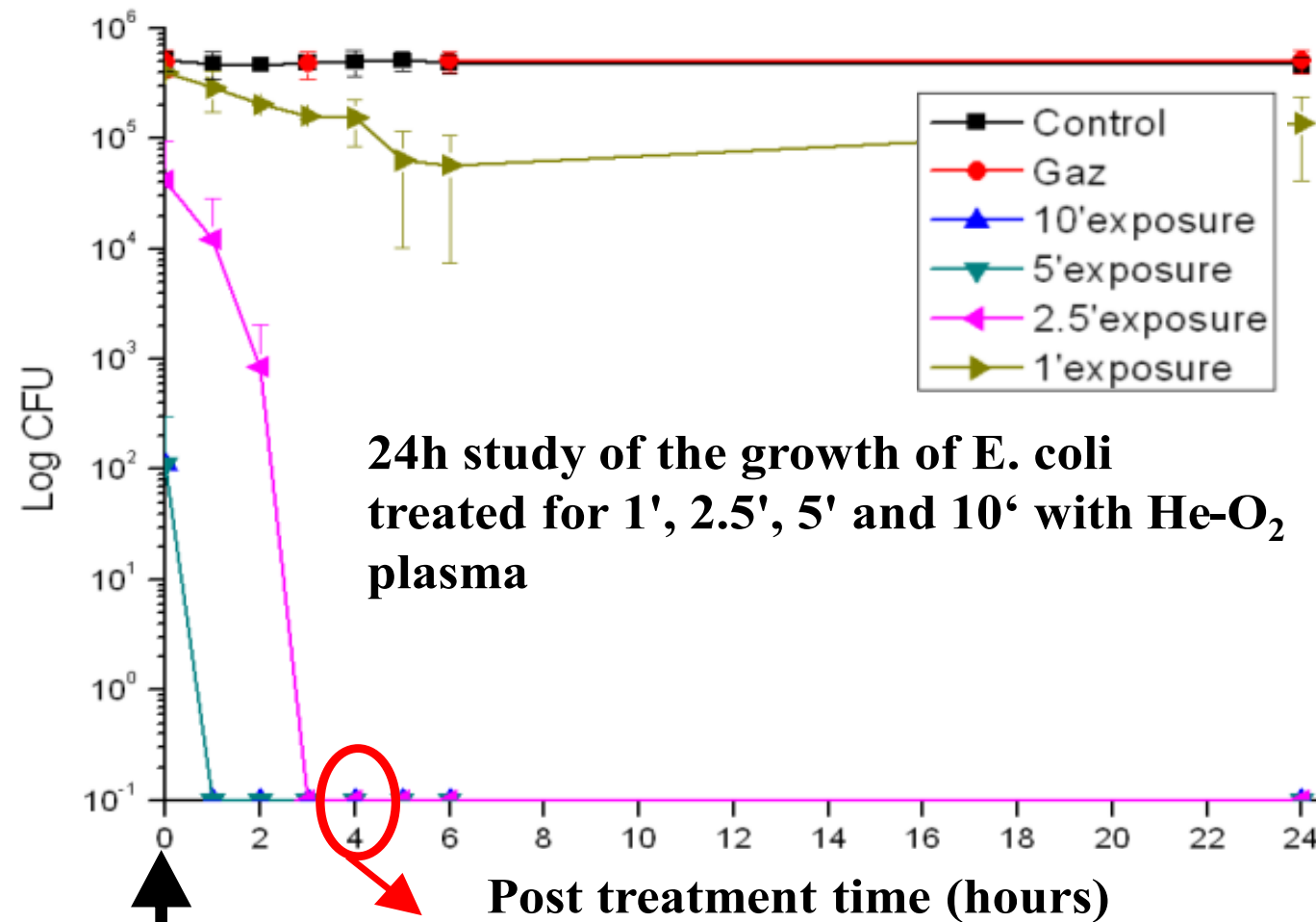

Treatment Distance: 10 mm Away from the Tube Exit
 $Q(\text{He-O}_2:99-1\%)=2 \text{ slm}$, $V_c=5 \text{ kV}$, $f=10 \text{ kHz}$, $r_c=1\%$

Treatment

SEM Images

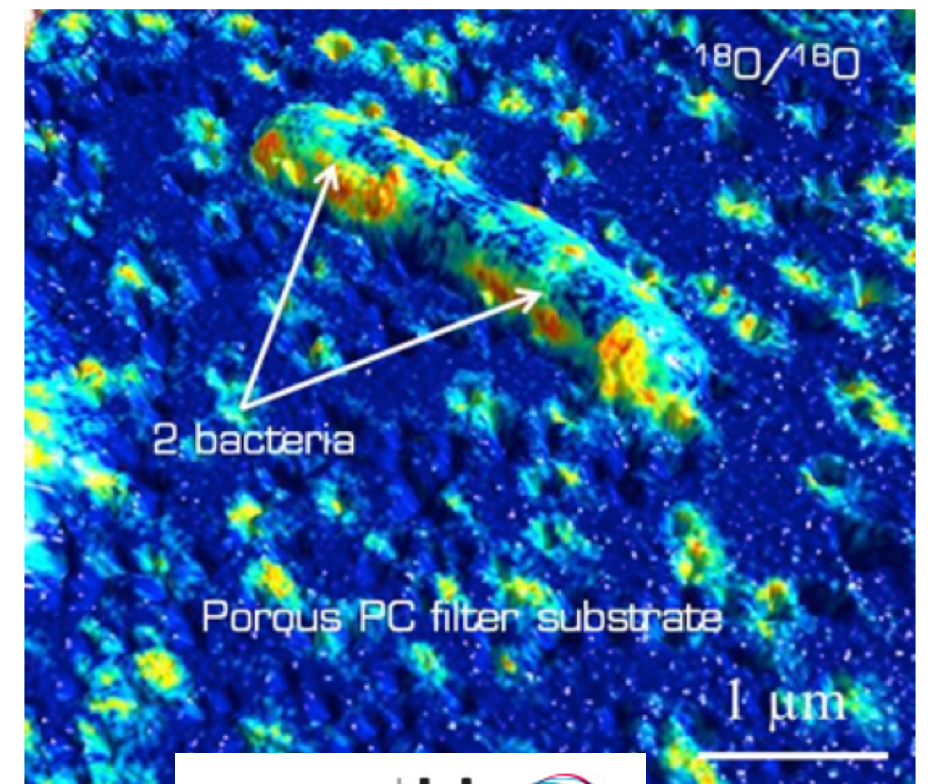
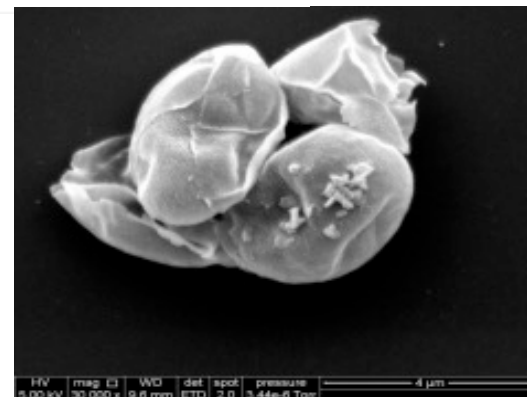
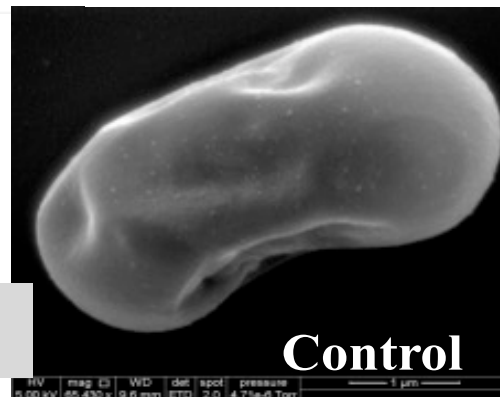

Clément et al., Study of Reactive Oxygen or/and Nitrogen Species Binding Processes on E. coli Bacteria with Mass Spectrometry Isotopic Nanoimaging, *New Journal of Physics* 13 (2011) 113040 (12pp)

Duday, Clément et al., NanoSIMS50 analyses of Ar/¹⁸O plasma-treated Escherichia coli bacteria, *Plasma Processes and Polymers*, vol 10, Issue 10, p 864–879, 2013

Dezest, Clément et al., Oxidative modification and electrochemical inactivation of *Escherichia coli* upon cold atmospheric plasma exposure, *PLOS One*, 2017, 0173618

IONIZATION WAVE

Parasites

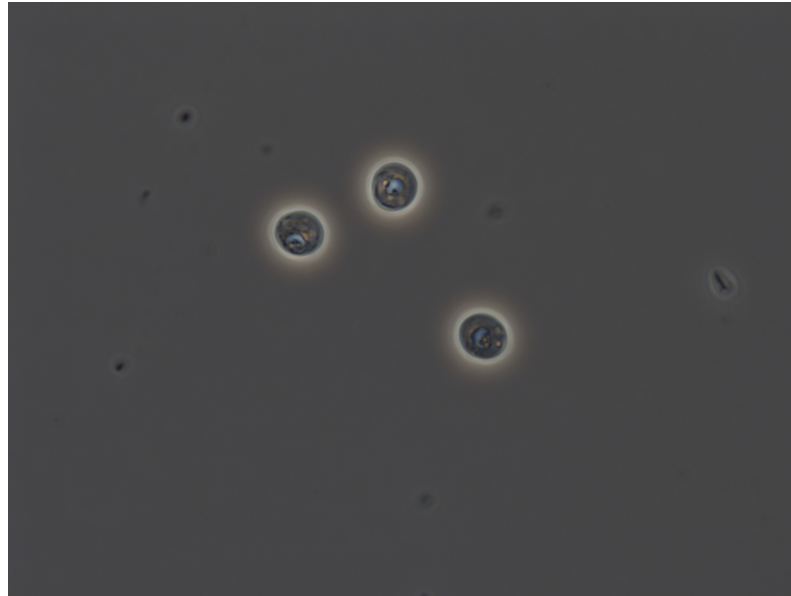

Cryptosporidium parvum oocysts are composed of a capsid containing four infectious sporozoites. Cell integrity is well marked by a luminous crown around the oocysts.

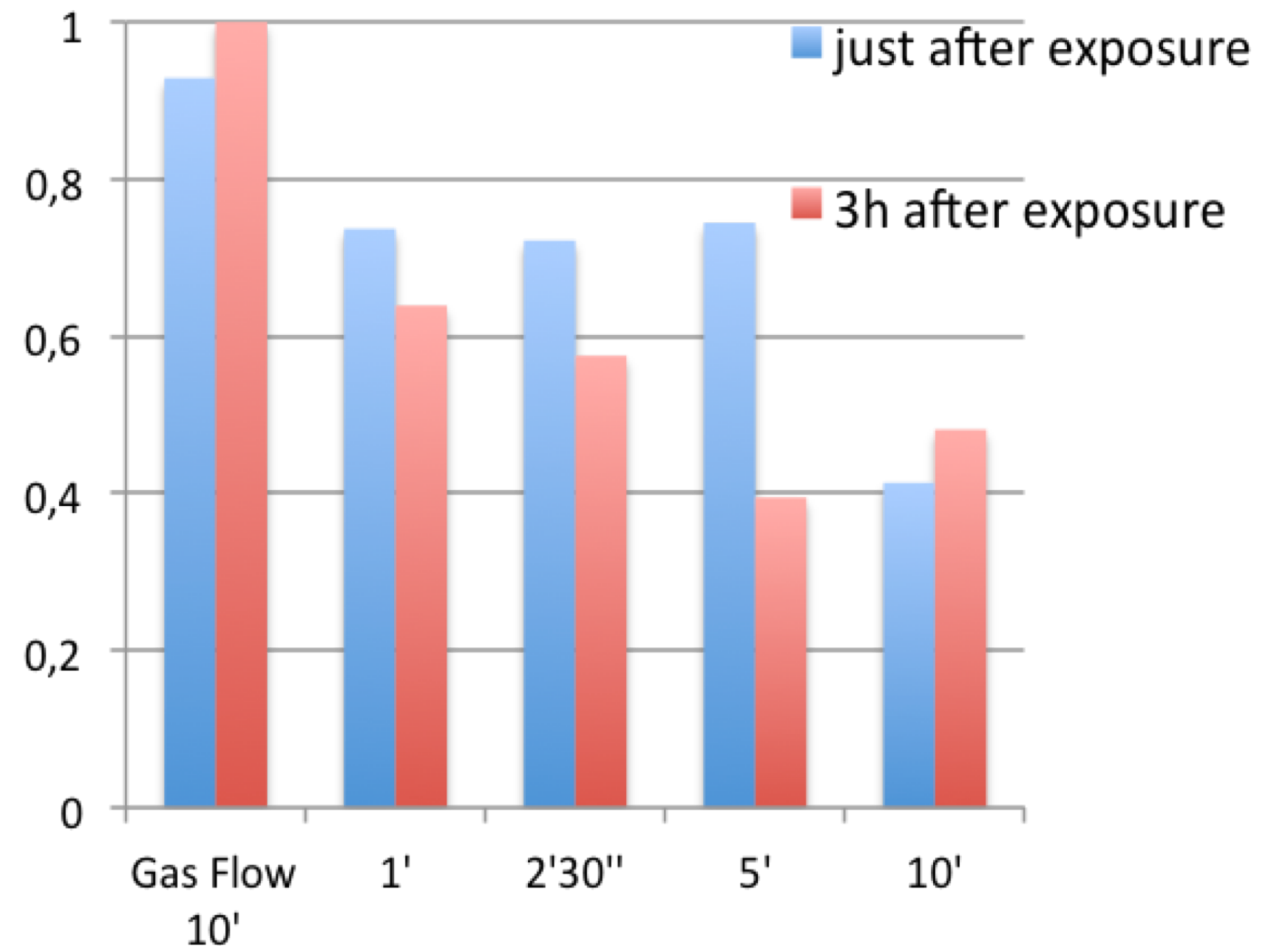
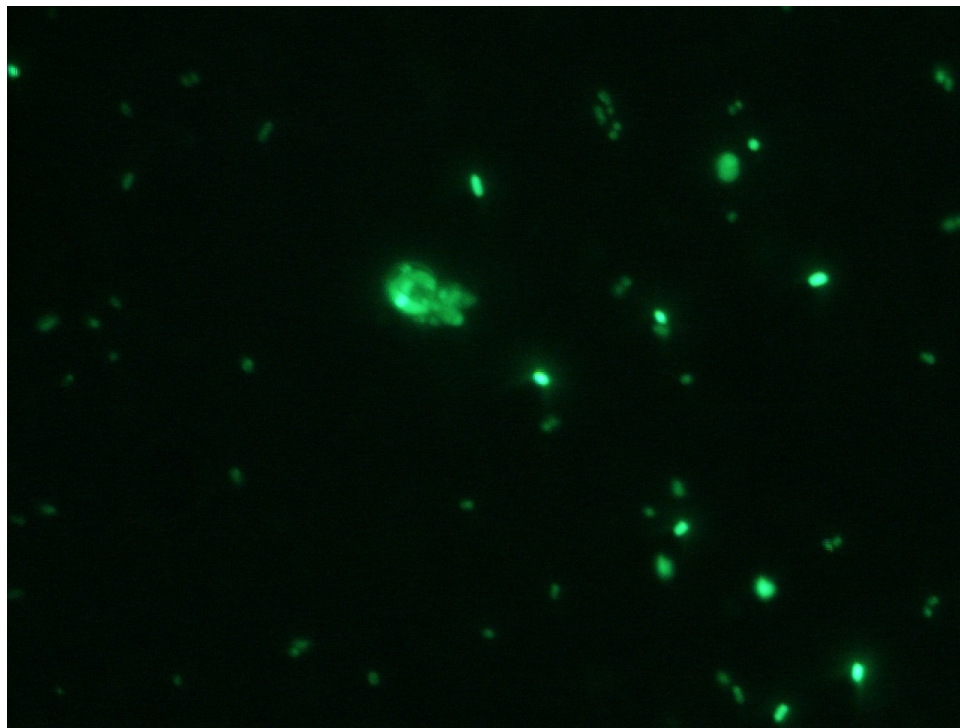

Drs C. Penny, J-P Cambus, A. Valentin

IONIZATION WAVE

Lack of mechanisms understanding

What are the interactions?

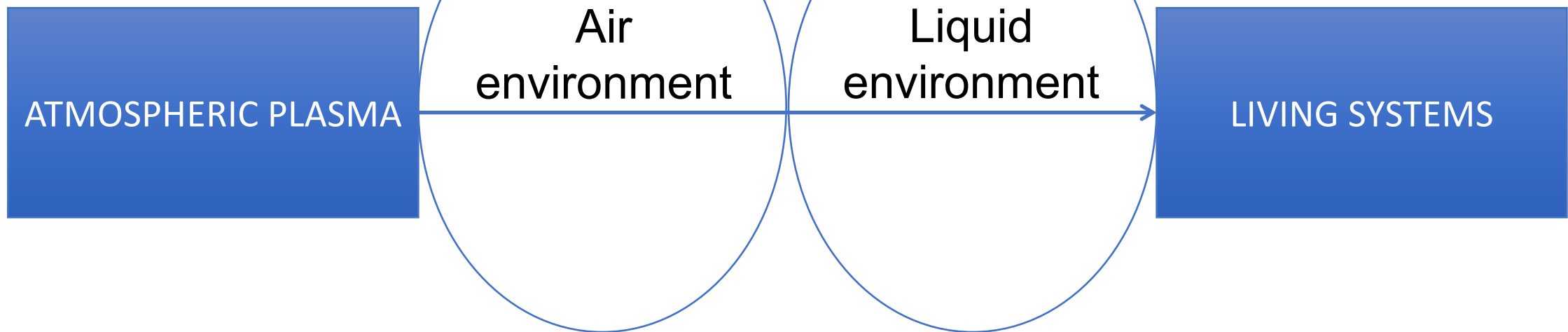
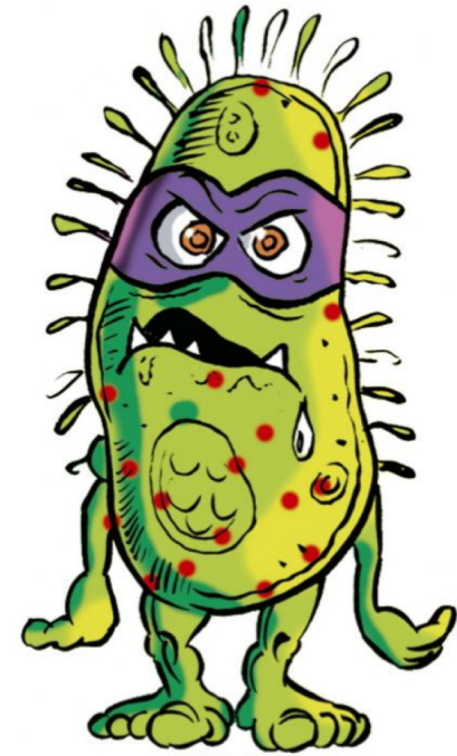

PLASMA-AIR and PLASMA-LIQUID INTERFACES

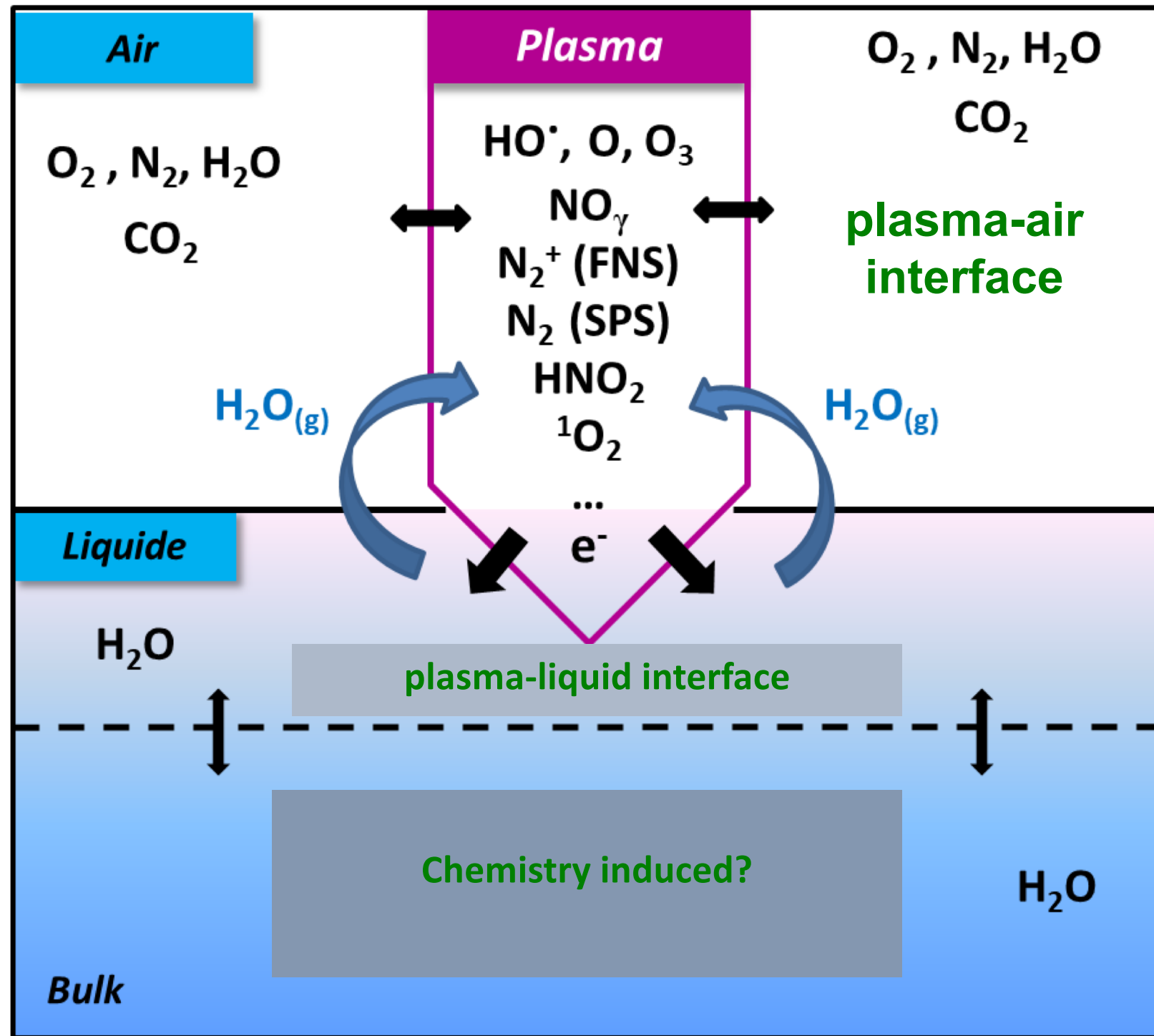

phD UPPA
Girard F. Pau

IONIZATION WAVE in interaction with air and water environments

Possible mechanisms



	In the gas	In the liquid (PBS: phosphate buffer saline)
H₂O₂	$\text{HO}^\circ + \text{HO}^\circ \rightarrow \text{H}_2\text{O}_2$ $\text{N}_2 (\text{A}^3\Sigma_u^+) + \text{H}_2\text{O}_{(\text{g})} \rightarrow \text{HO}^\circ + \text{H}^\circ + \text{N}_2$ $\text{N}_2 (\text{B}^3\Pi) \rightarrow \text{N}_2 (\text{A}^3\Sigma_u^+) + h\nu$ <p>N₂ (FPS) observed in the plasma: N₂(A)</p>	$\text{HO}^\circ + \text{HO}^\circ \rightarrow \text{H}_2\text{O}_2$
NO₂⁻	$\text{HO}^\circ + \text{NO}^\circ + \text{M} \rightarrow \text{HNO}_2 + \text{M}$ <p>M : collision partner</p>	$\text{HNO}_2 + \text{HPO}_4^{2-} \rightleftharpoons \text{NO}_2^- + \text{H}_2\text{PO}_4^-$
NO₃⁻	$\text{NO}_2^\circ + \text{HO}^\circ + \text{M} \rightarrow \text{HNO}_3 + \text{M}^*$ <p>...</p>	$\text{HNO}_3 \rightleftharpoons \text{H}^+ + \text{NO}_3^-$ <p>...</p>

GAS-LIQUID INTERACTION

By using a shielding gas device !

Control of the air environment →

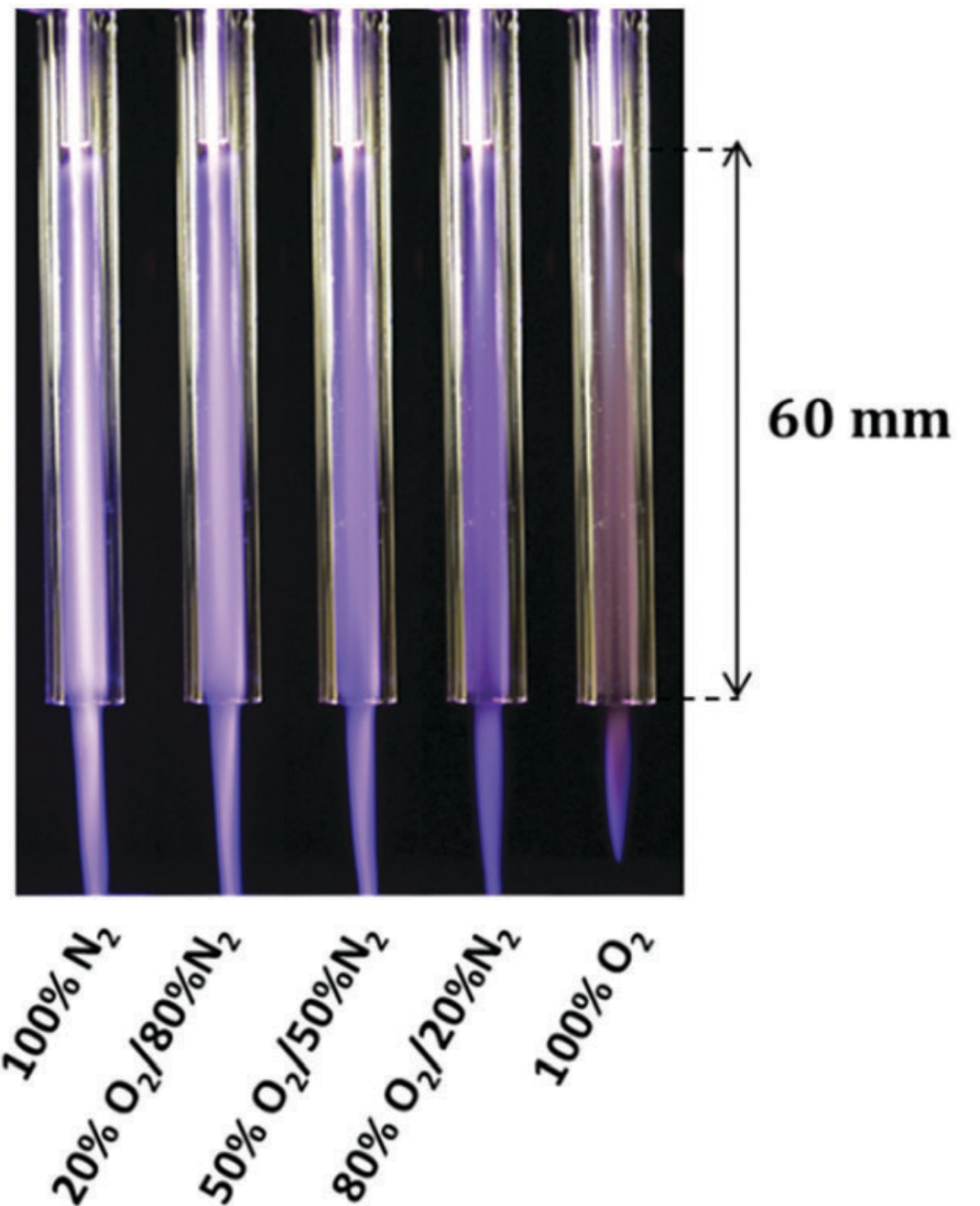
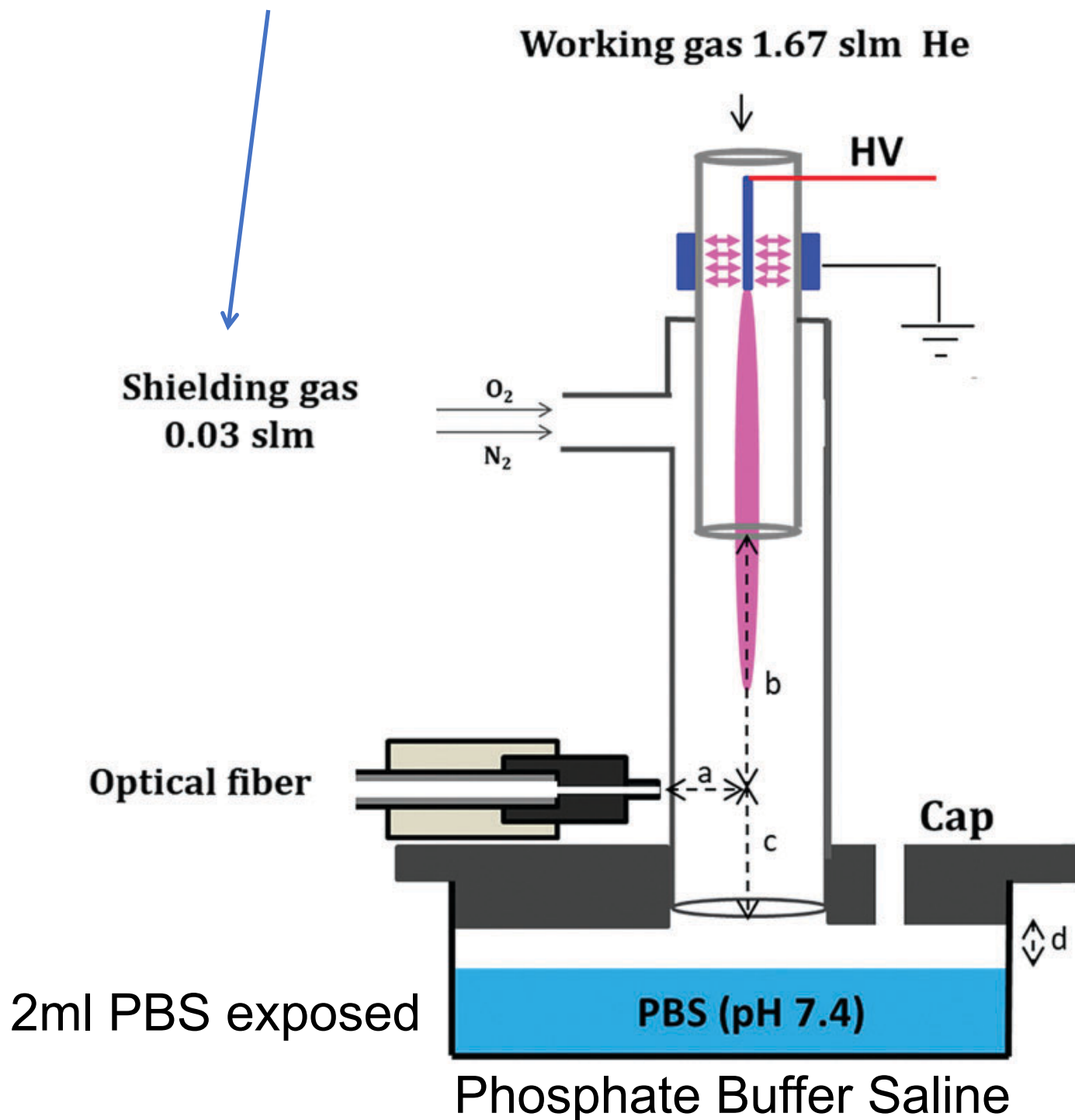

Girard, Clément et al.
Phys. Chem. Chem. Phys.
2018, 20, 9198-9210

Maximum of excited levels of He
for air mixture

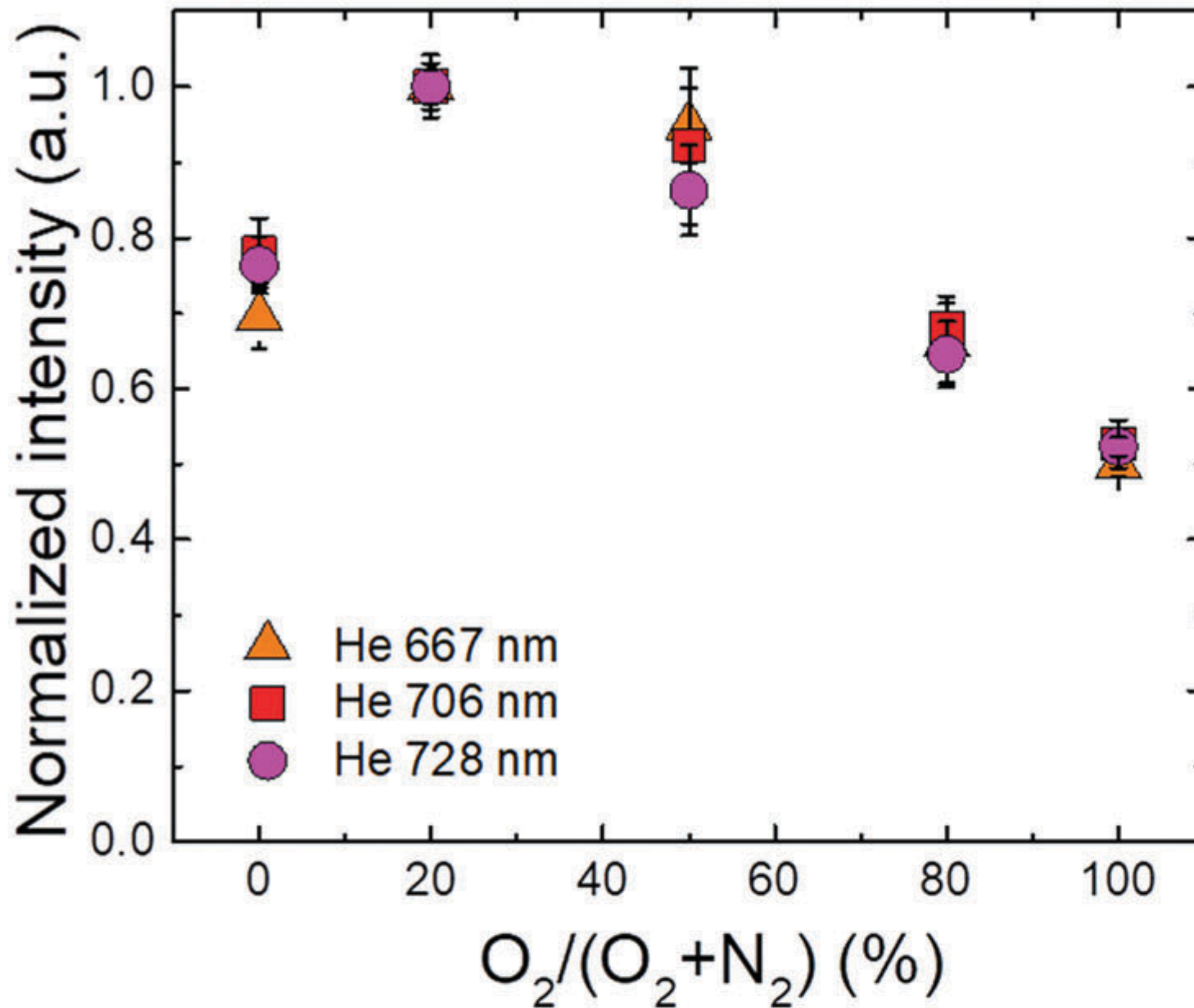

When increasing O₂ %, rapid decrease of NO and slower decrease of N₂ (SPS, FPS) and N₂⁺ (FNS)

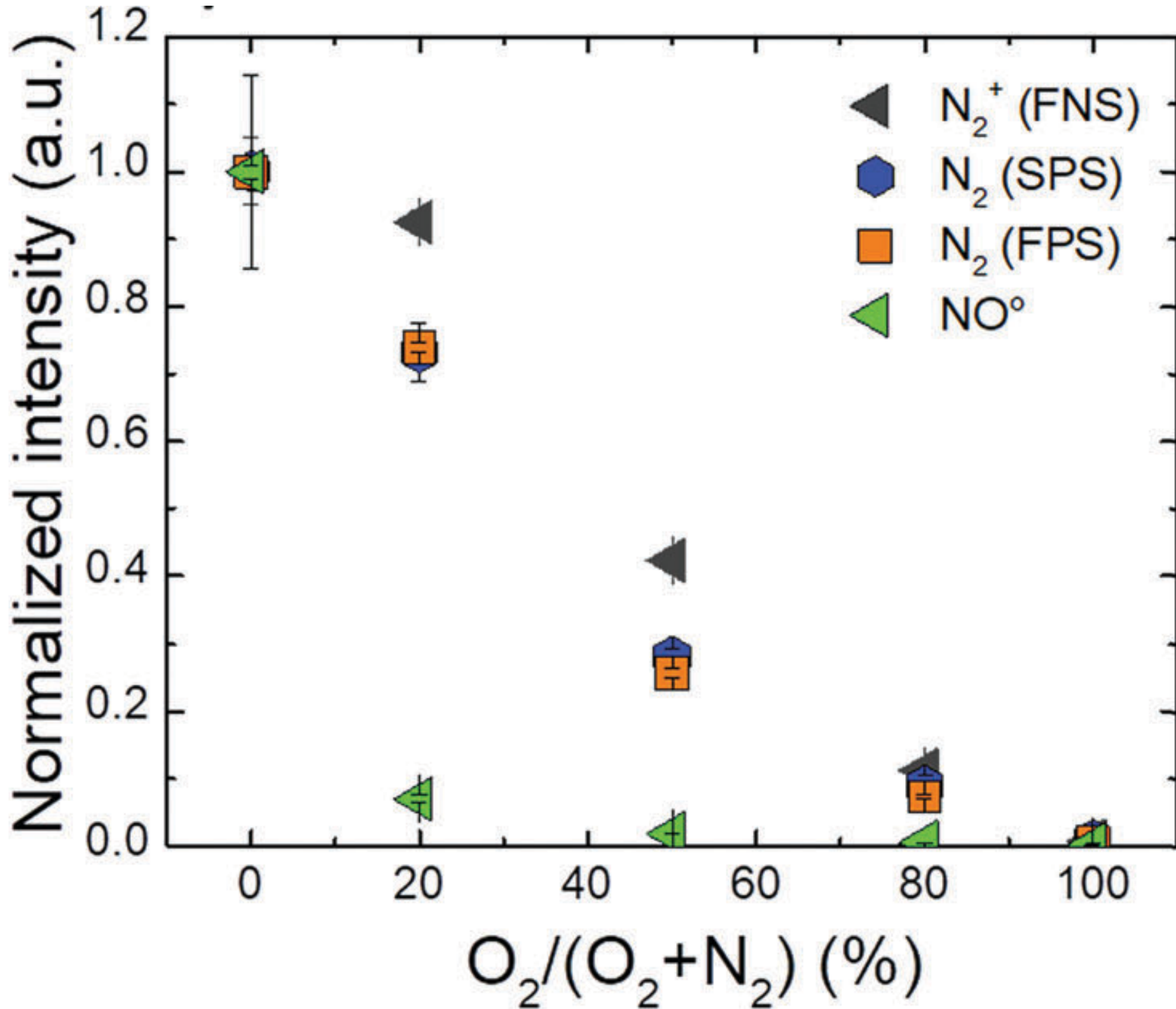

When increasing O₂ %, decrease of OH and H, increase of O and O₂⁺

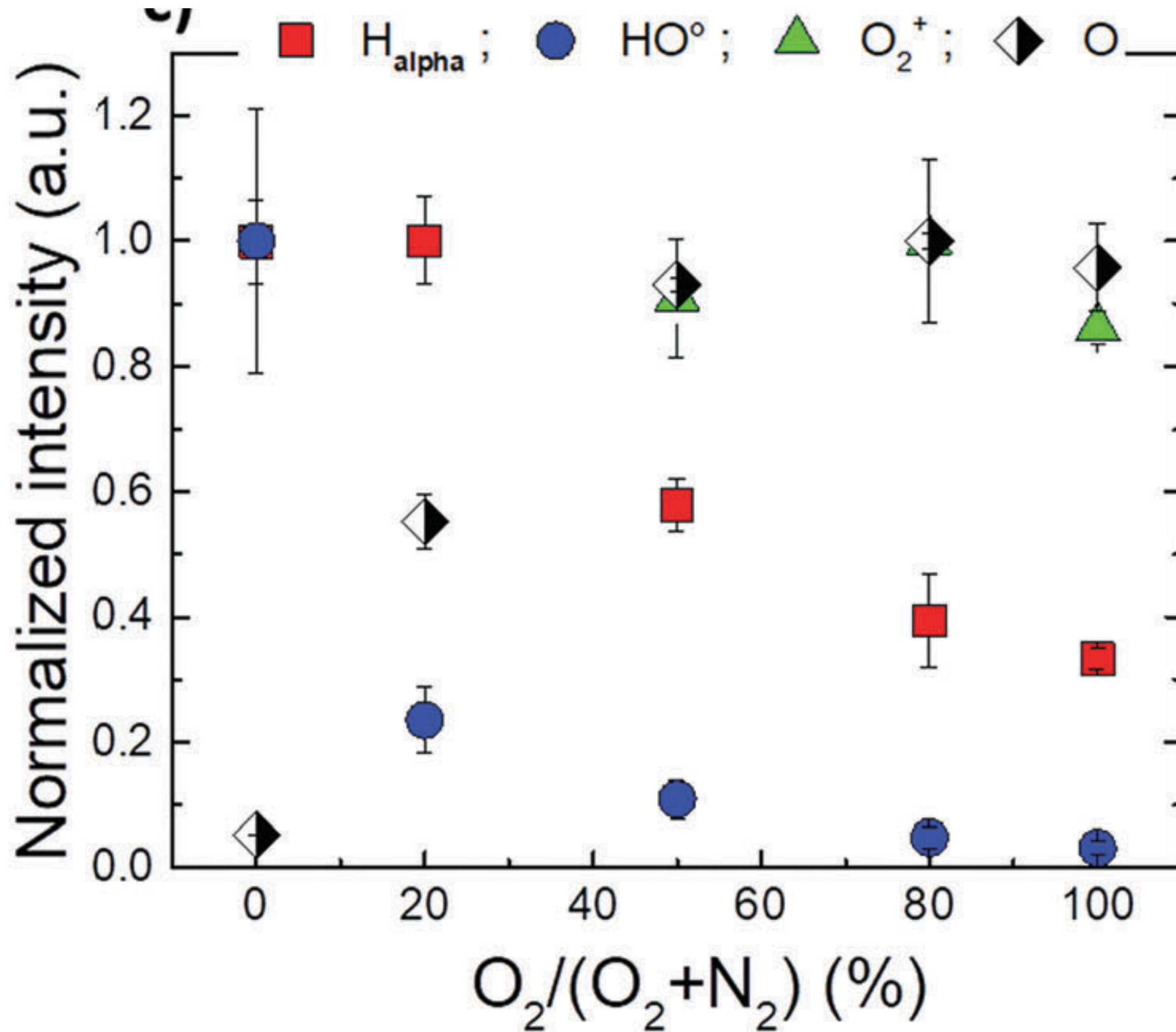

GAS-LIQUID INTERACTION

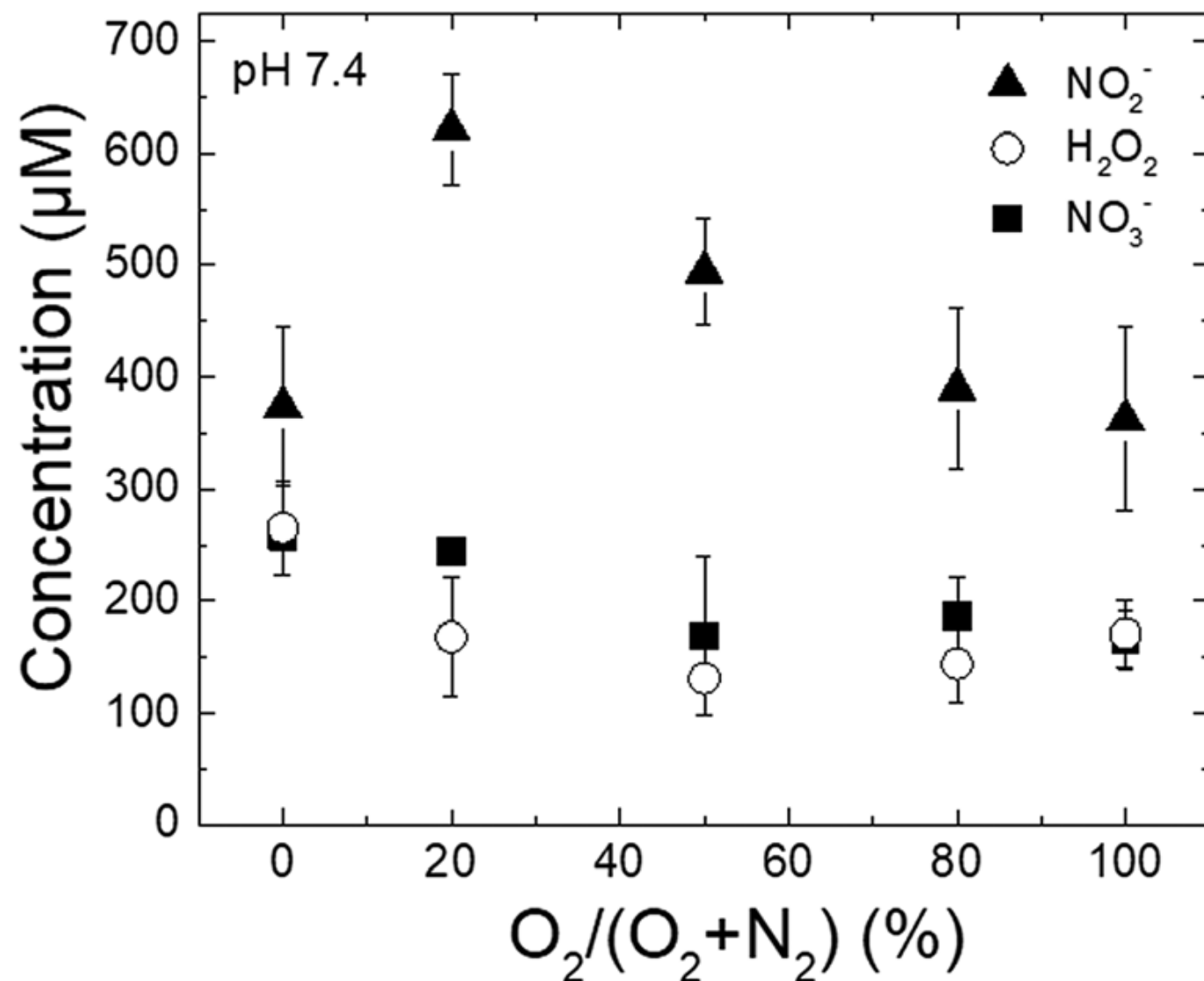

2ml PBS exposed

Girard, Clément et al.

Phys. Chem. Chem. Phys. 2018, 20, 9198-9210

Collab. ENSCBP Bordeaux : S. Arbault, V. Badets, P. Lefrançois

Electrochemistry

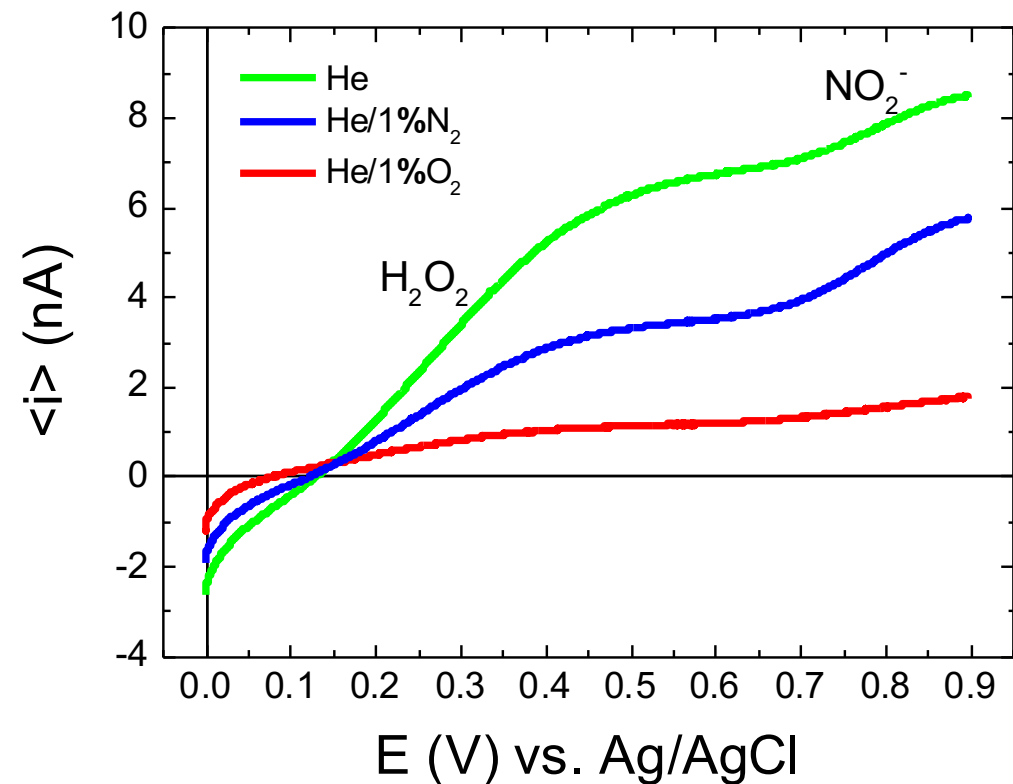

Absorption spectroscopy

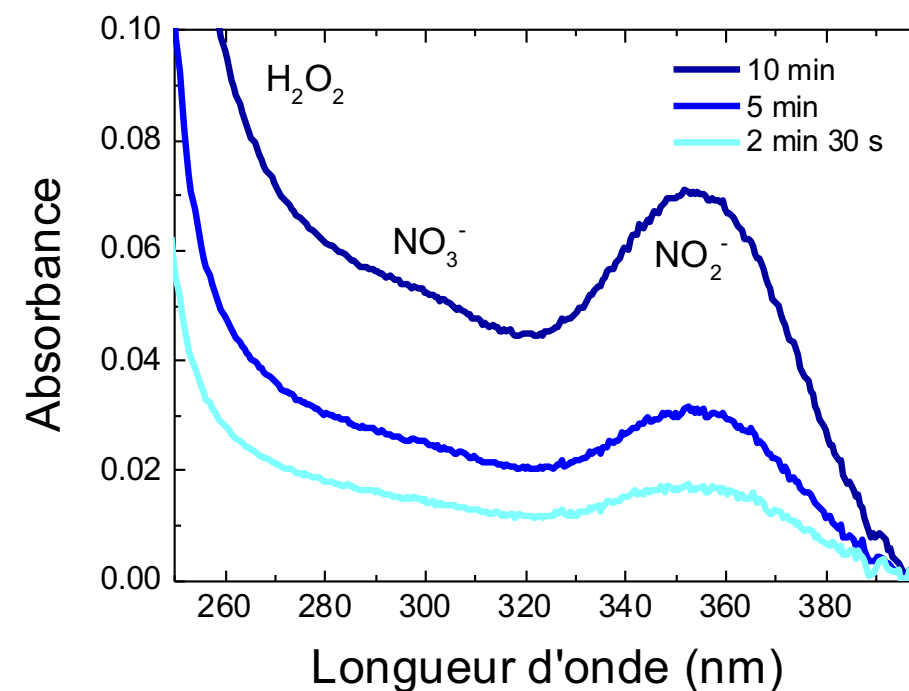

GAS-LIQUID INTERACTION

NO_2^- correlated with pH variation in buffered solution (PBS)

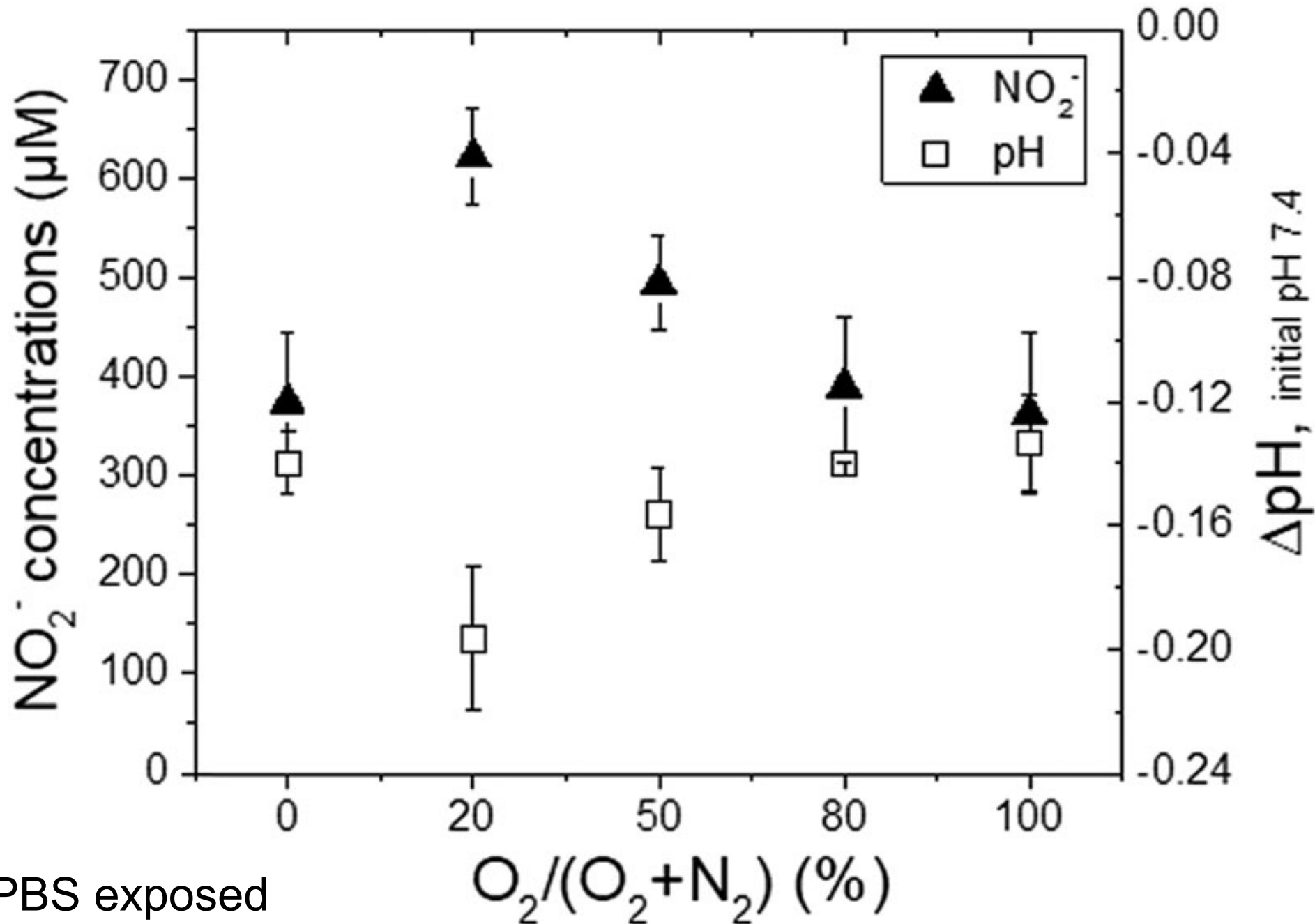

2ml PBS exposed

Measured by
Electrochemistry
and Absorption
spectroscopy

GAS-LIQUID INTERACTION

By changing pH, it is possible to measure unstable Species in solution

pH 12
Buffered solution
2ml PBS

PEROXYNITRITE

Measured by
Absorption
spectroscopy

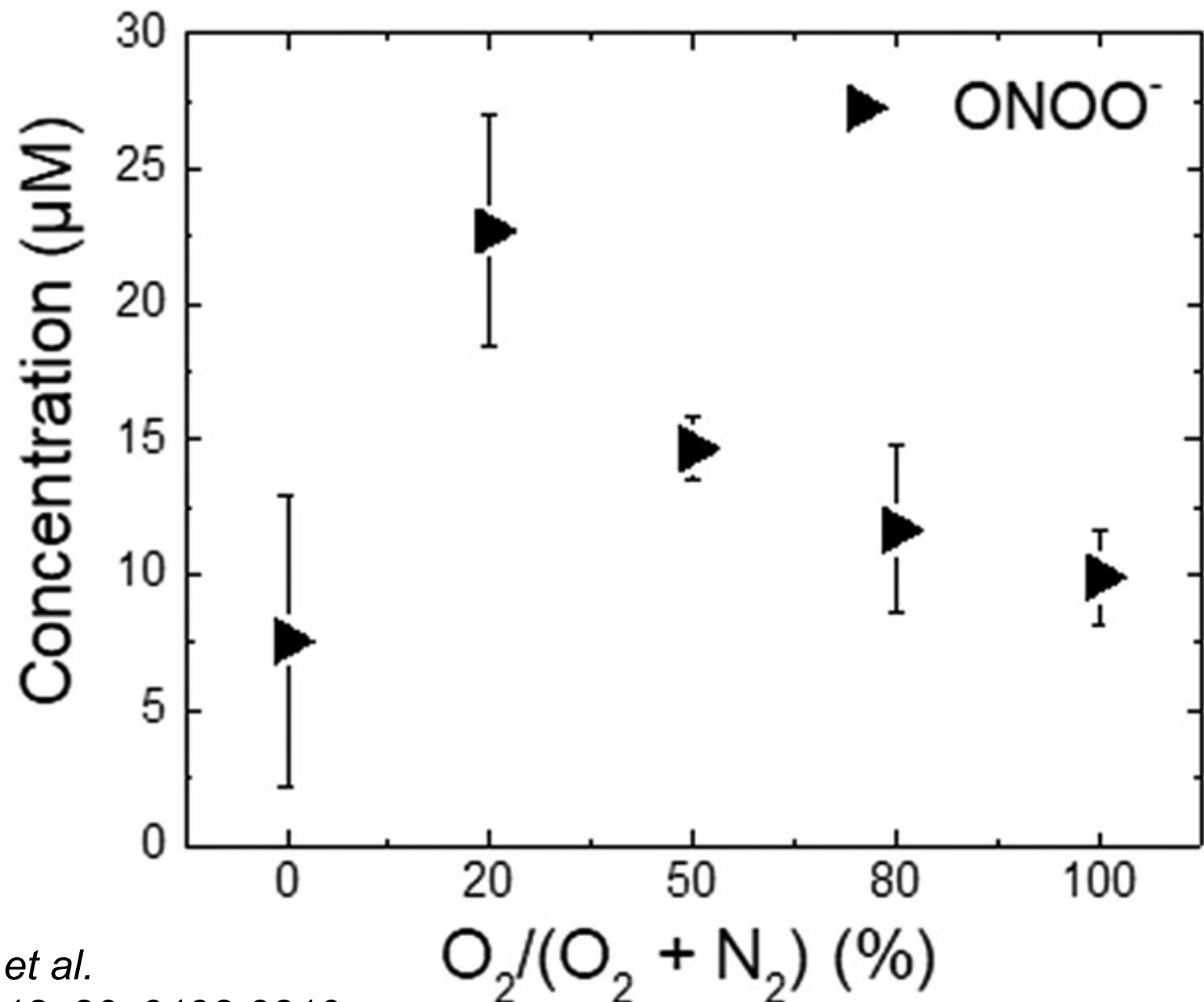

Girard, Clément et al.

Phys. Chem. Chem. Phys. 2018, 20, 9198-9210

GAS-LIQUID INTERACTION

By changing pH, it is possible to measure unstable Species in solution

ANION
SUPEROXYDE $O_2^{\circ -}$

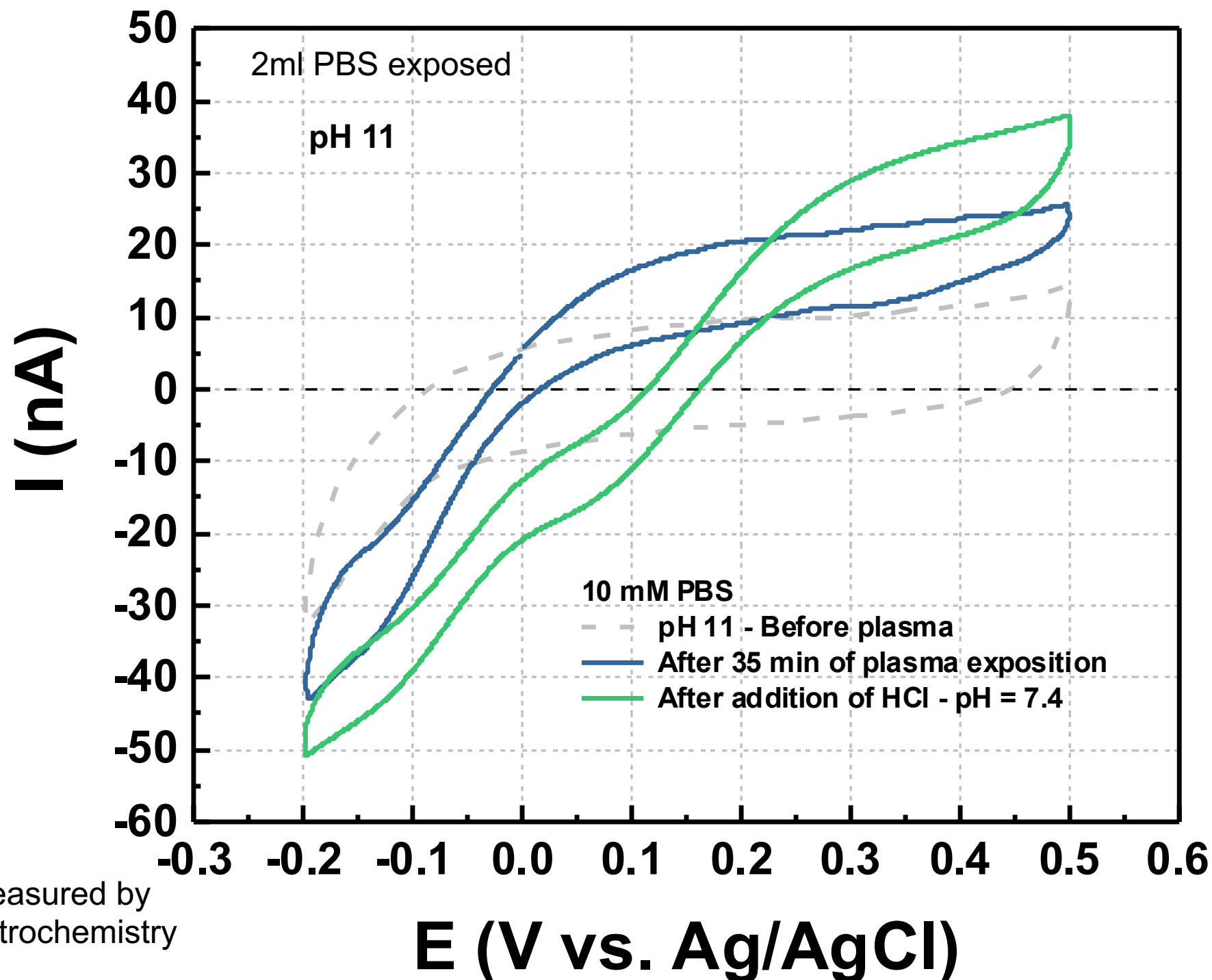

- After exposition to plasma:
- 1- $O_2^{\circ -}$ detected in PBS at pH 11
 - 2- $O_2^{\circ -}$ is fully converted to H_2O_2 after adjustment of pH to 7.4

GAS-LIQUID INTERACTION

Helium plasma produces ROS and RNS including:

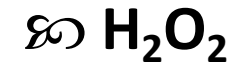

Abs. Spectroscopy
Electrochemistry
(20-30 $\mu\text{M}\cdot\text{min}^{-1}$)*



Electrochemistry (not quantified)



Abs. Spectroscopy
(0.2-1.2 $\mu\text{M}\cdot\text{min}^{-1}$)*



Abs. Spectroscopy
Electrochemistry
(30-45 $\mu\text{M}\cdot\text{min}^{-1}$)*



Abs. Spectroscopy
(30-45 $\mu\text{M}\cdot\text{min}^{-1}$)*

** With N_2 as shielding gas*

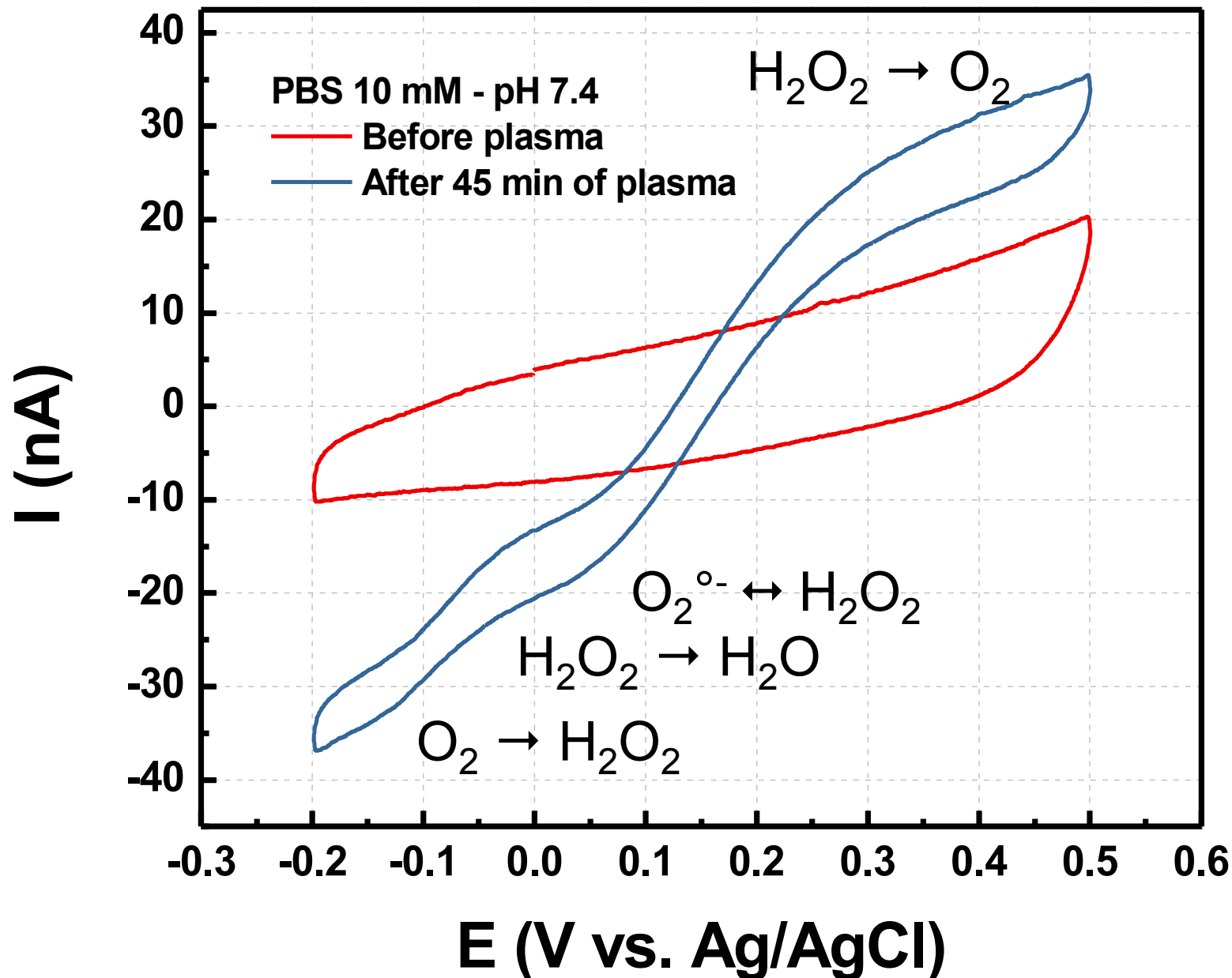

GAS-LIQUID INTERACTION in situ, during plasma exposure

Electrical fields implied in ionization waves are in the order of magnitude of some **10kV.cm⁻¹**

Sretenovic, G. et al., J.Appl.Phys. 452 2017, 121 (12), 123304.

Razavizadeh, S. et al., Plasma Sources Sci. Technol. 2018, 27 (7), 075016.

Difficulties to measure very low faradaic currents, in the **nA range**, in the presence of high electric fields used for plasma formation

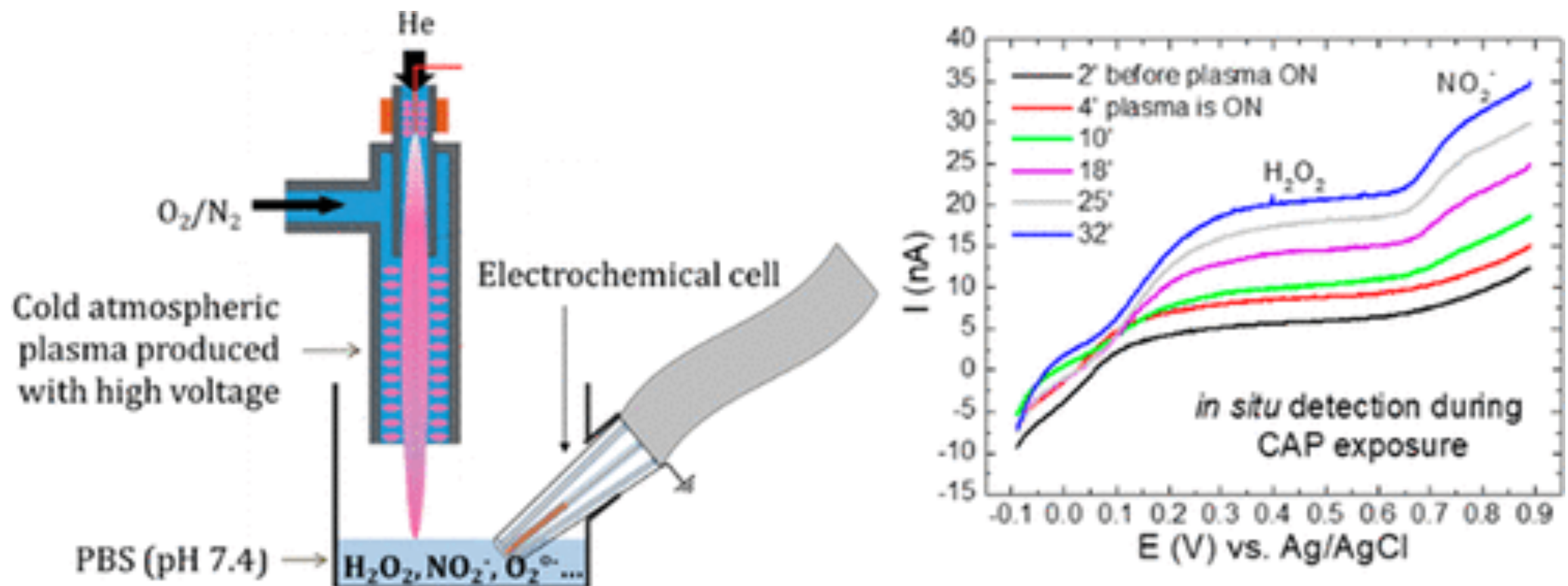

Reactive oxygen species generated by cold atmospheric plasmas in aqueous solution: Successful Electrochemical Monitoring in Situ under a High Voltage System, Girard, Clément et al., Analytical Chemistry, 2019

<https://doi.org/10.1021/acs.analchem.9b01912>

GAS-LIQUID INTERACTION in situ, during plasma exposure

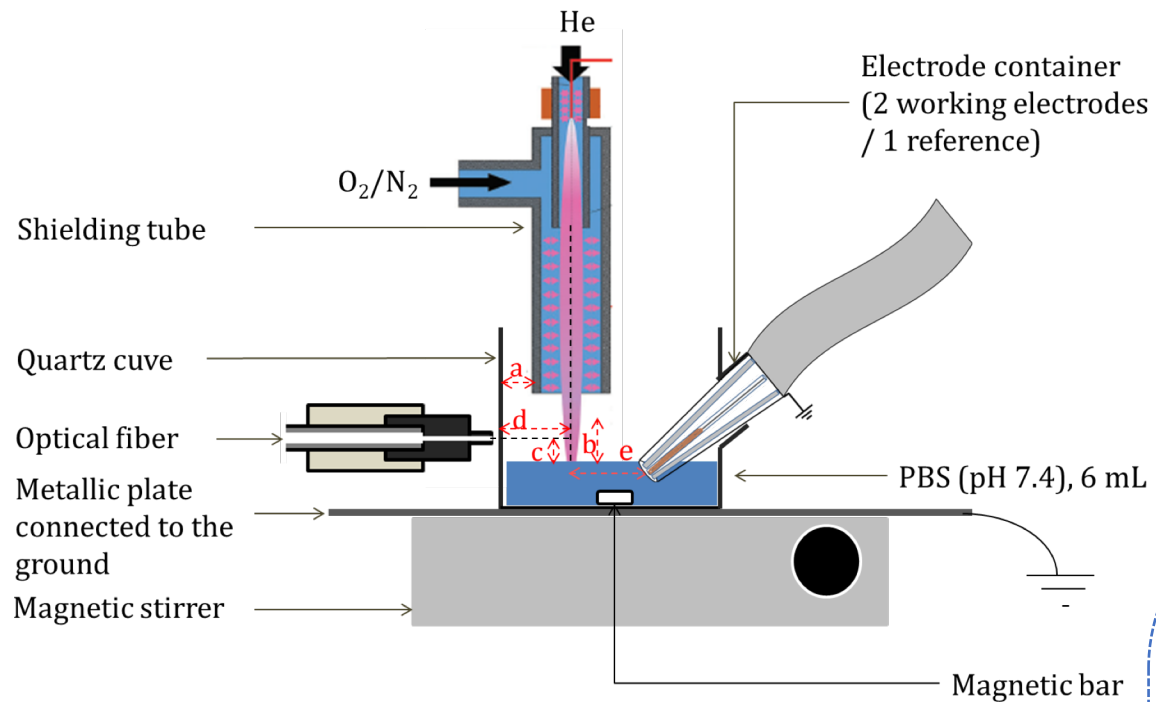

Different types of shielded electrodes used during plasma exposure

WE = Platinized Pt disk (25 μm Ø, 37.5 μC)
Ref = Ag/AgCl wire
CE = Pt wire

Black Pt working electrode
(enhanced selectivity and sensibility)

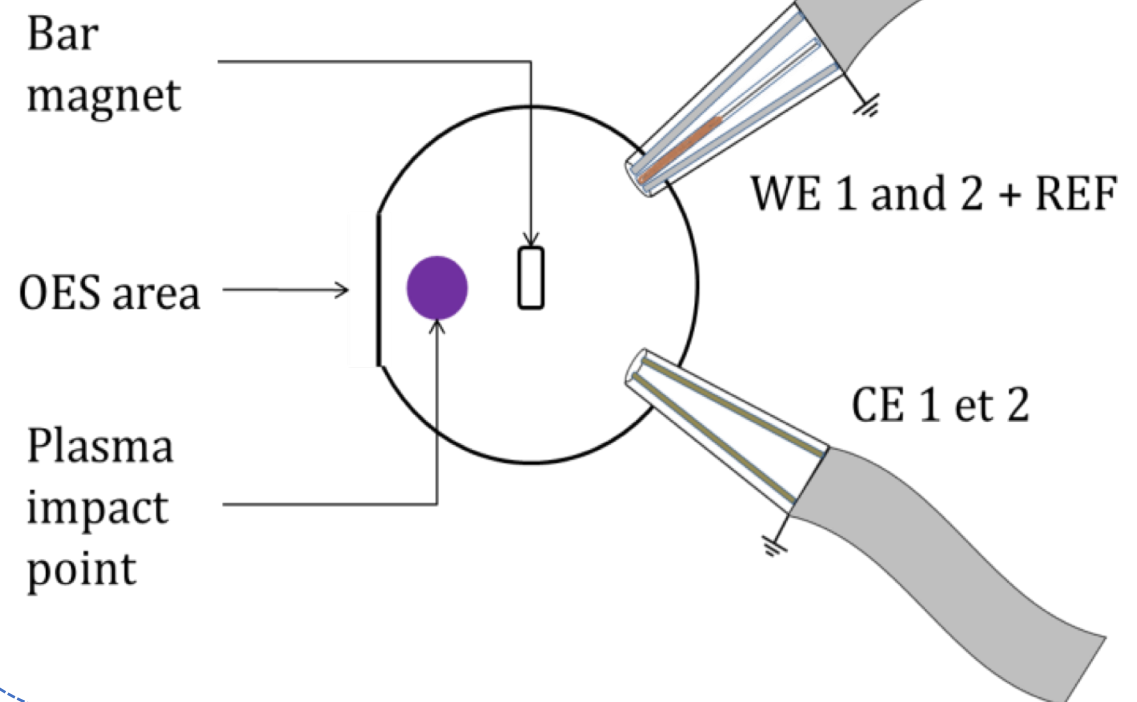
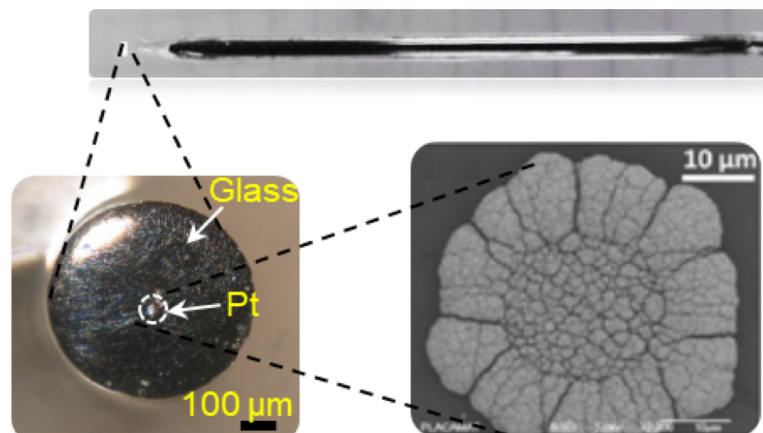

GAS-LIQUID INTERACTION in situ, during plasma exposure

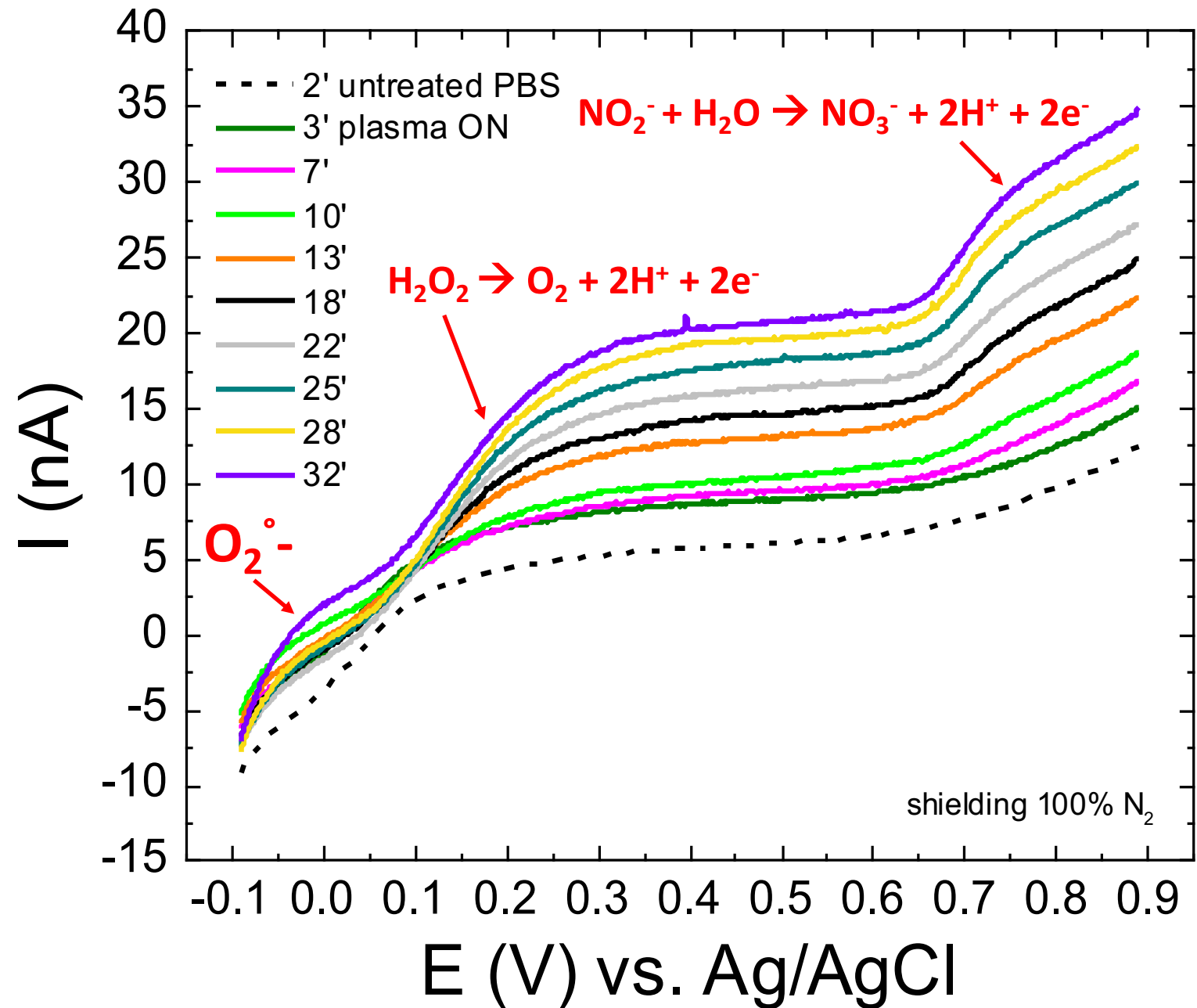
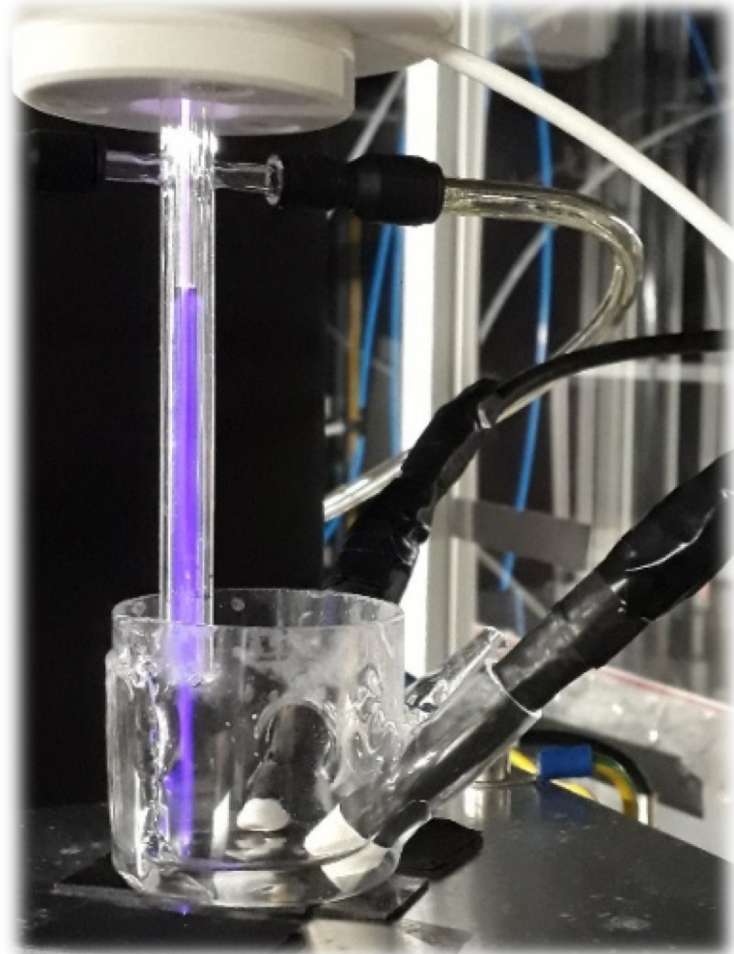

Possibility to follow long-lived and short-lived RONS produced in PBS during plasma exposure

IONIZATION WAVE in interaction with materials

Lack of mechanisms understanding



What are the interactions?

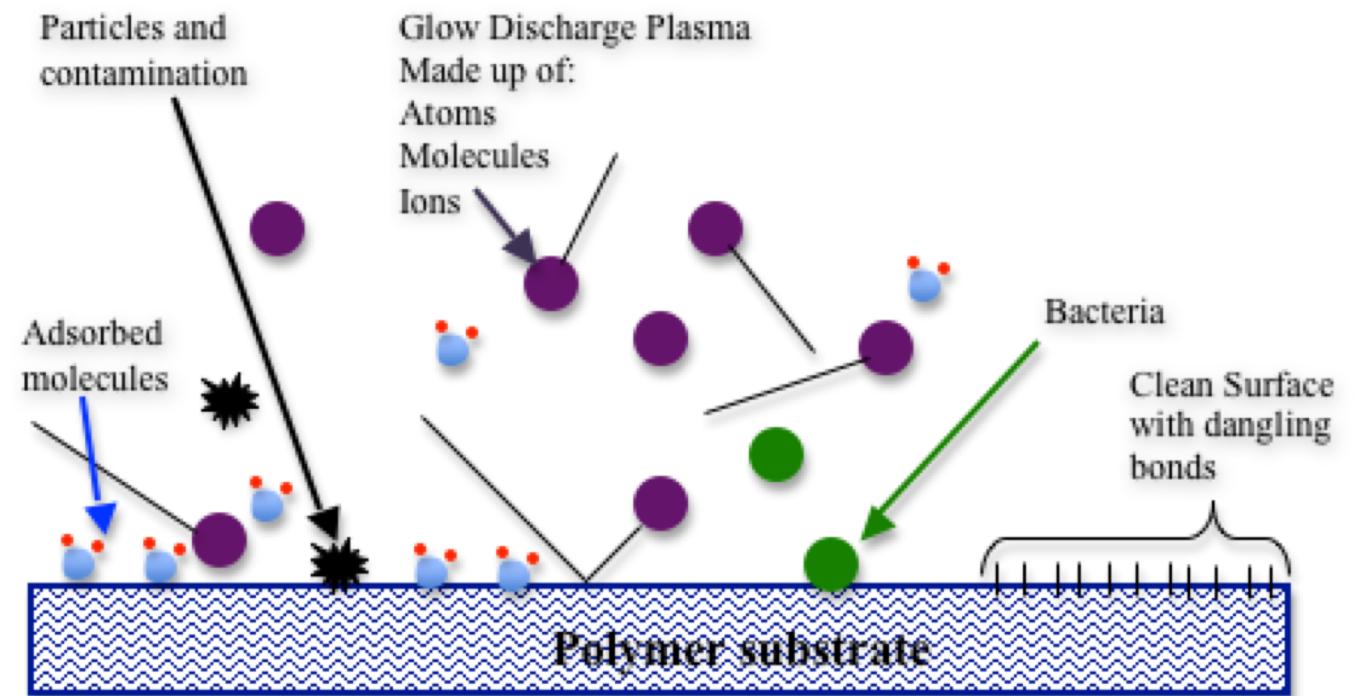

https://en.wikipedia.org/wiki/Biomaterial_Surface_Modifications

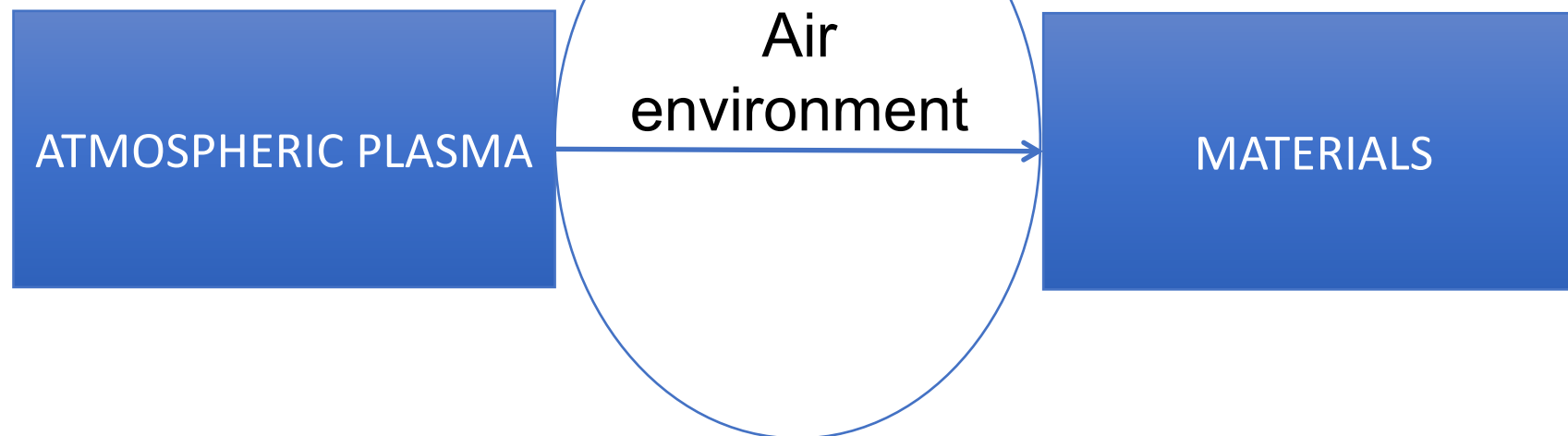

- Numerous applications
- Cleaning
- Etching
- Functionalization
- Coating
- Sterilization
- Enhanced cell growth

...

These atmospheric plasmas can be used for polymer surface treatments ...



Plasma He + 1% O₂

Exposition of Thermoplastic Polyurethane (TPU)
Wettability analyses of the surfaces exposed

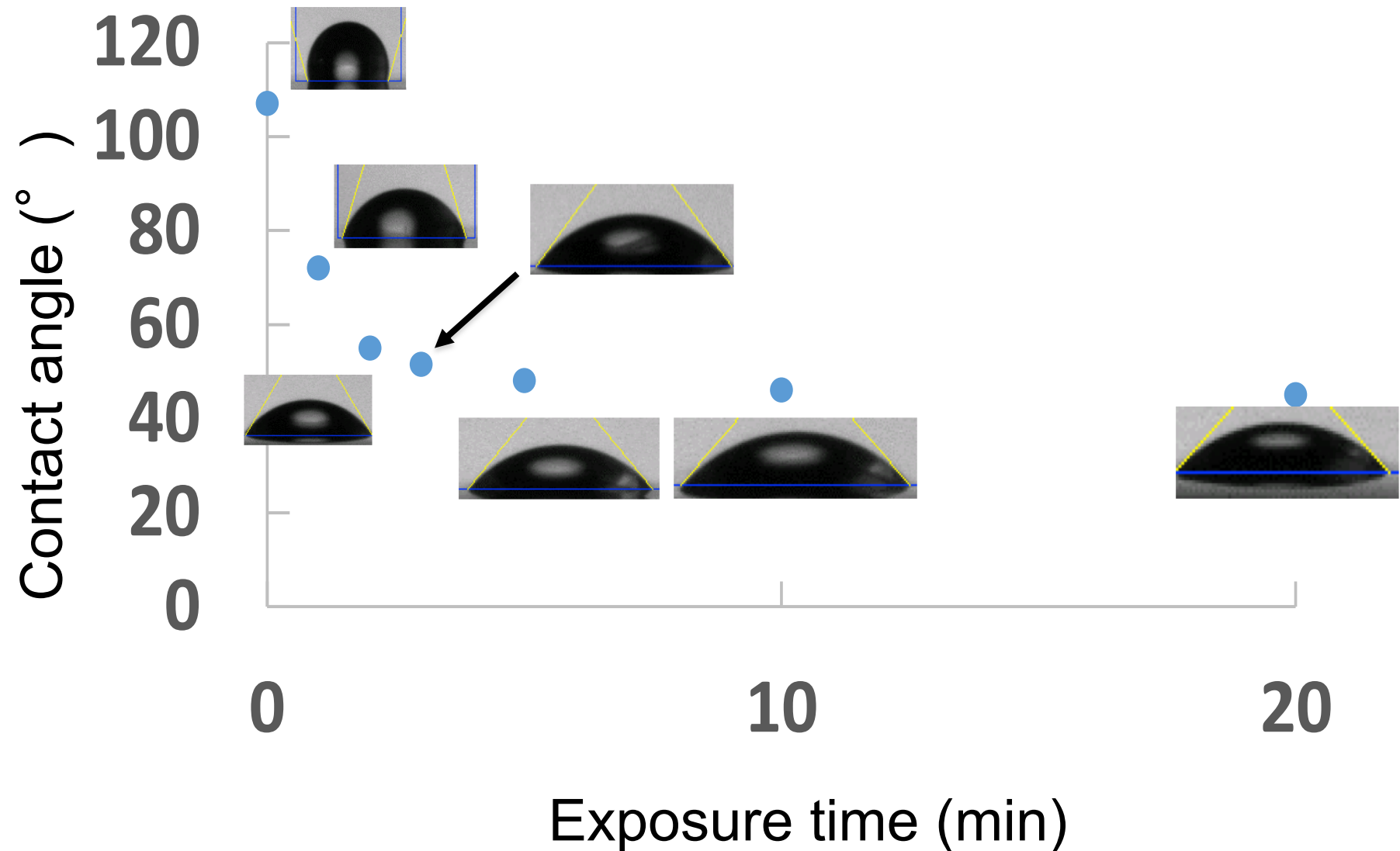

Different types of polymers exposed...

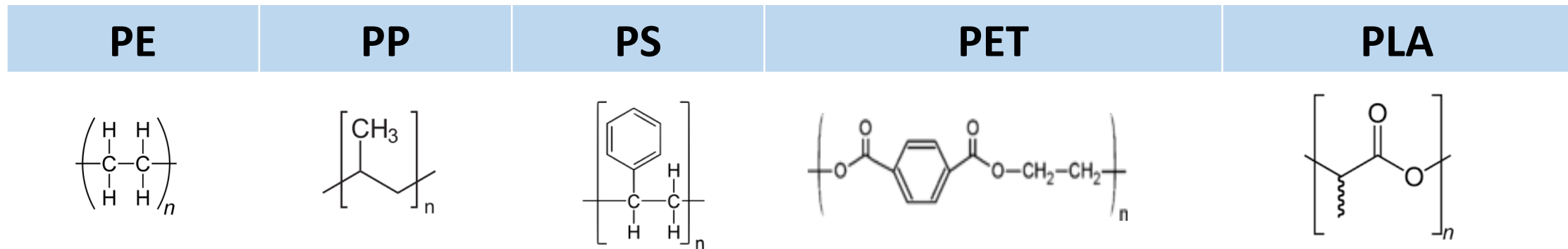

He - N2 CAP

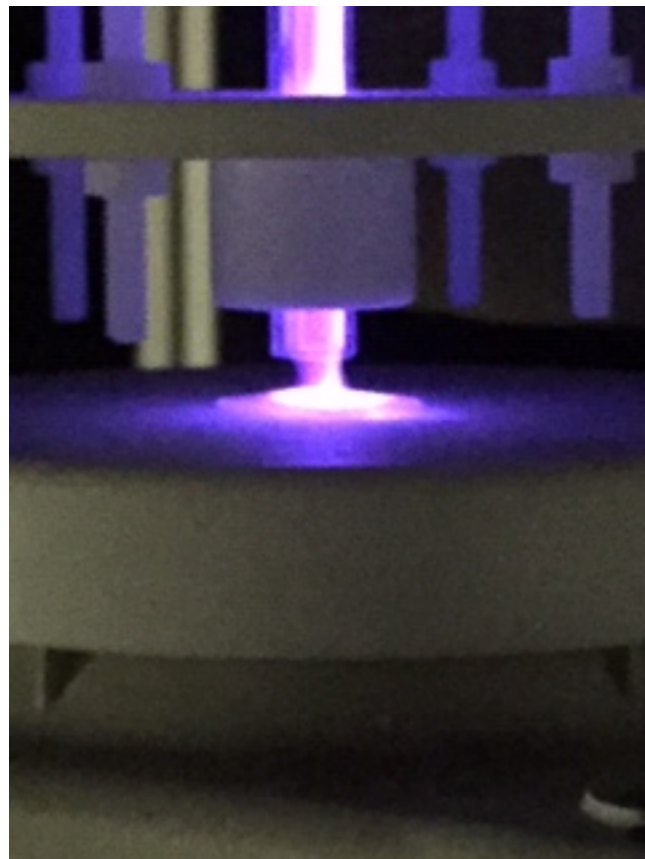

He CAP

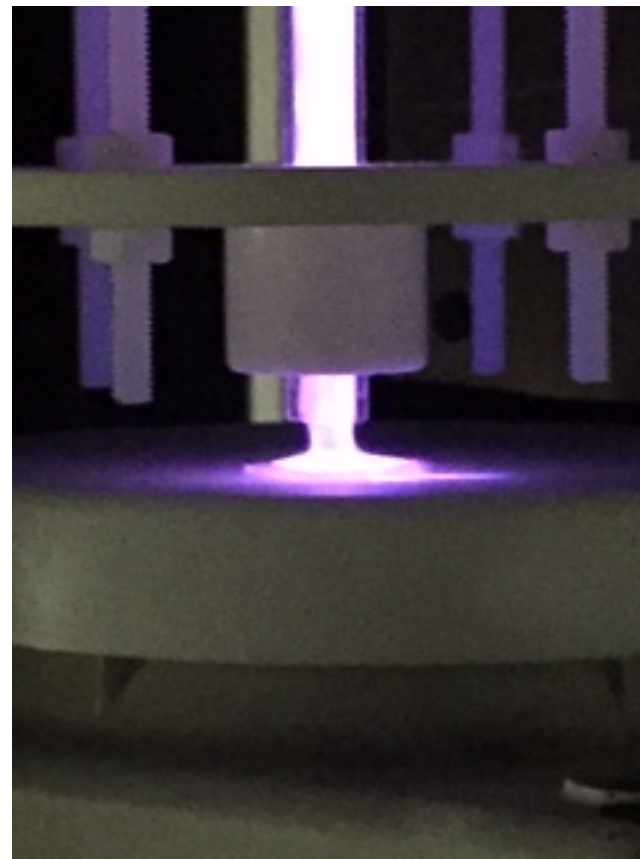

He - O2 CAP

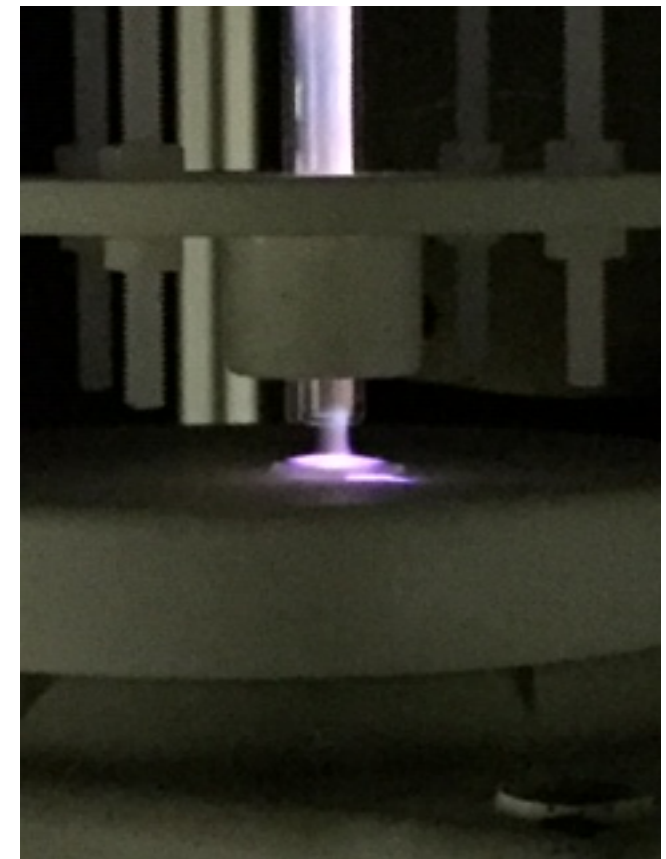

IR-ATR analyses of PLA substrates exposed

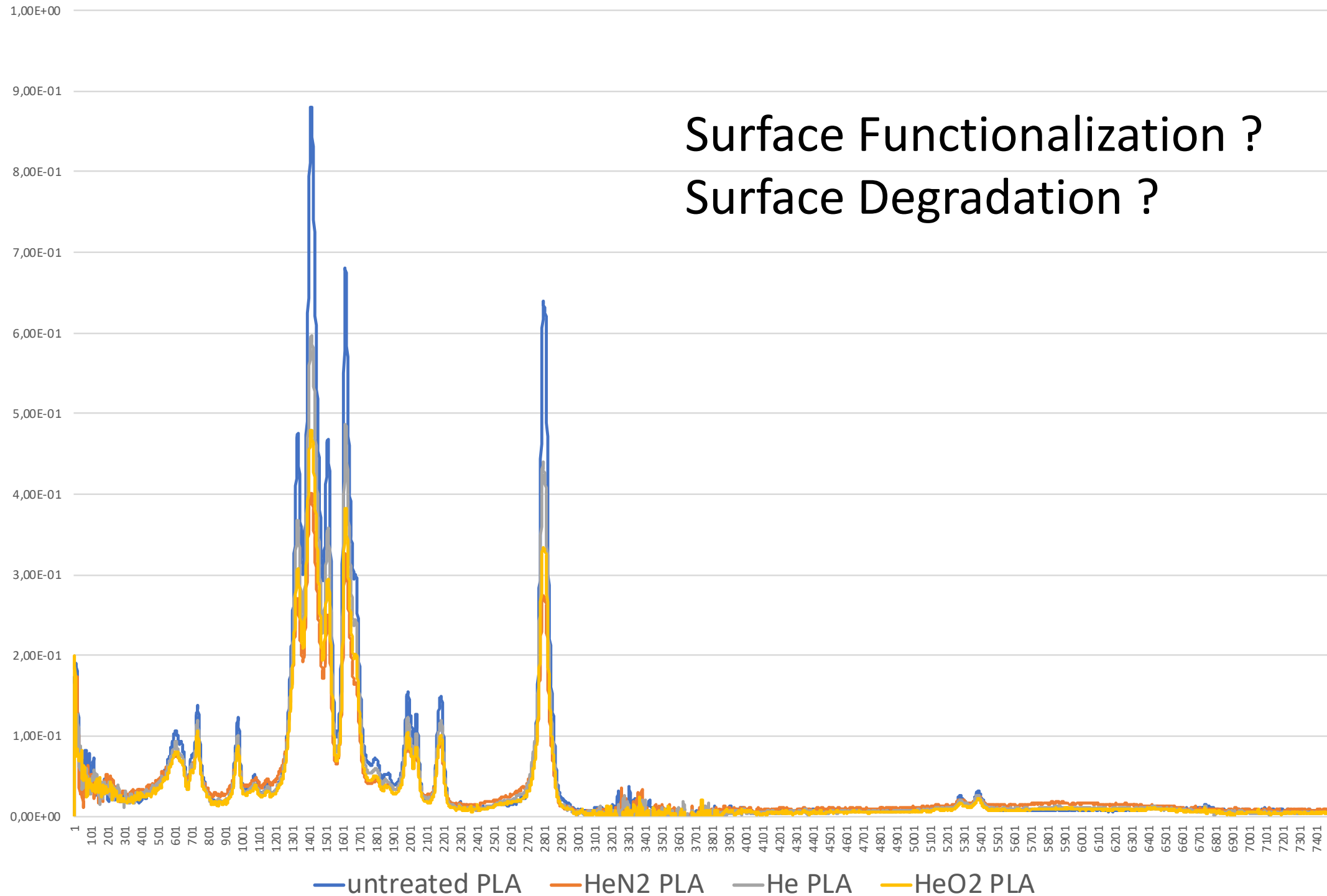

Another example

IR-ATR analyses of PET substrates exposed

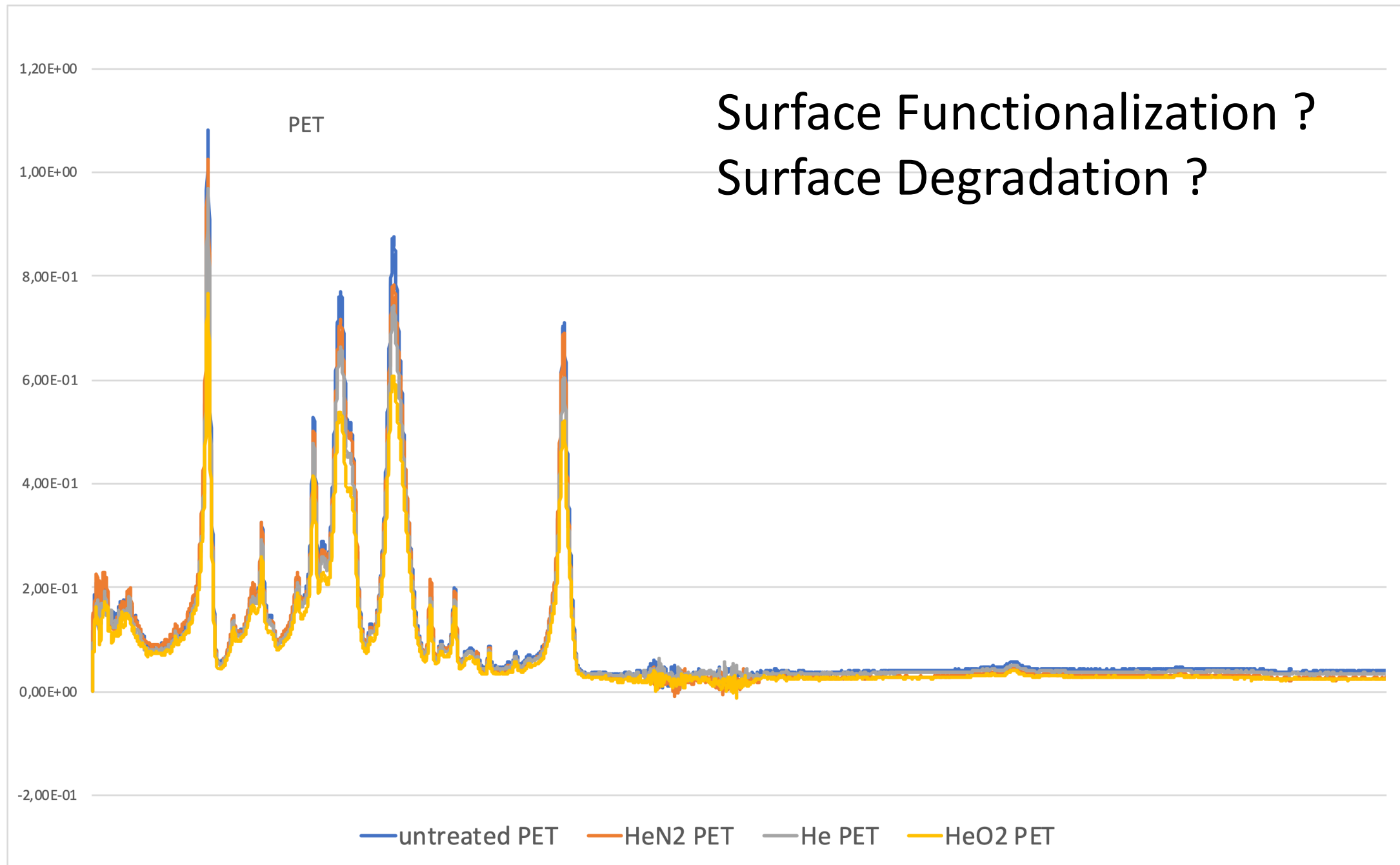

Another example

IR-ATR analyses of PP substrates exposed

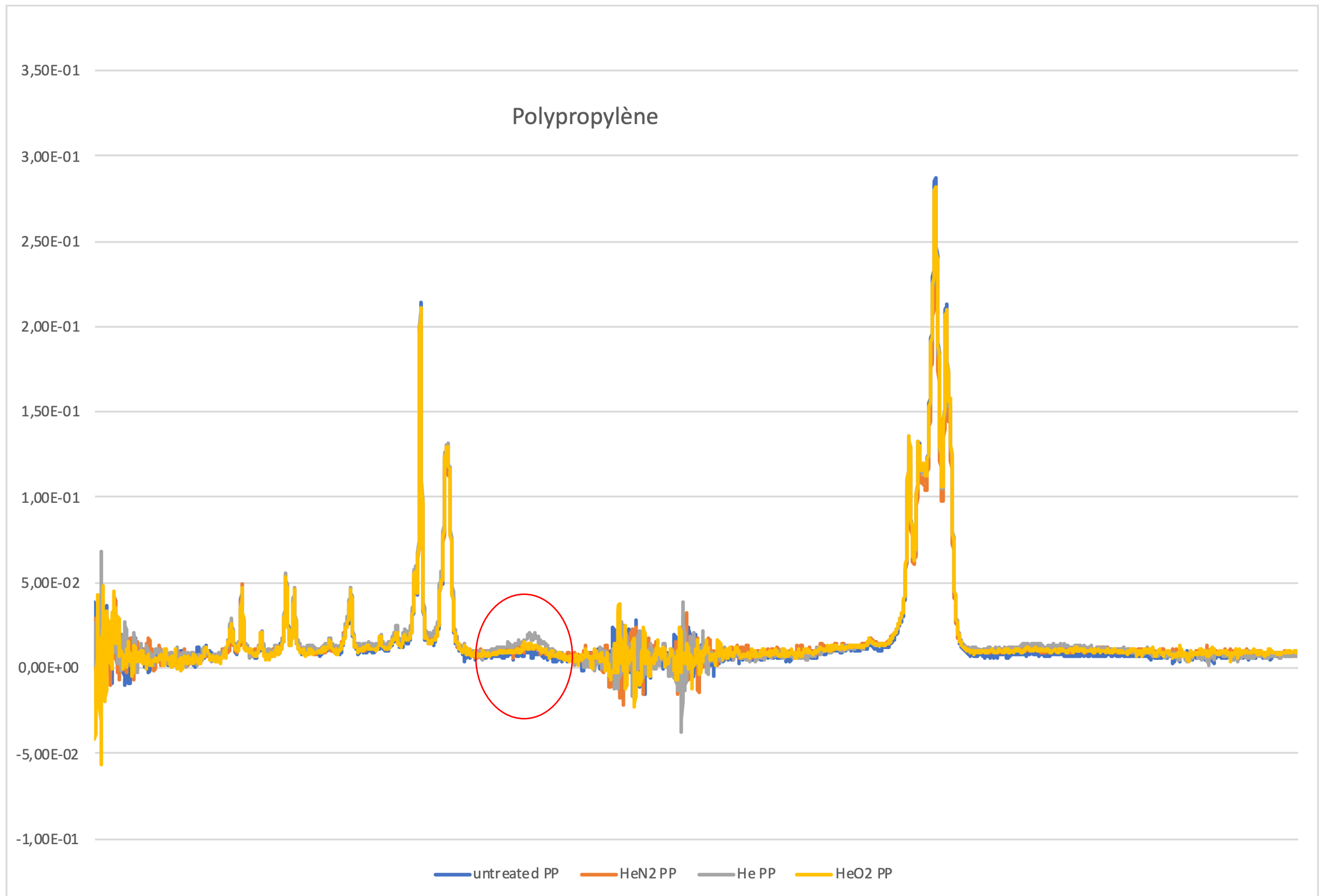

Another example

IR-ATR analyses of PP substrates exposed

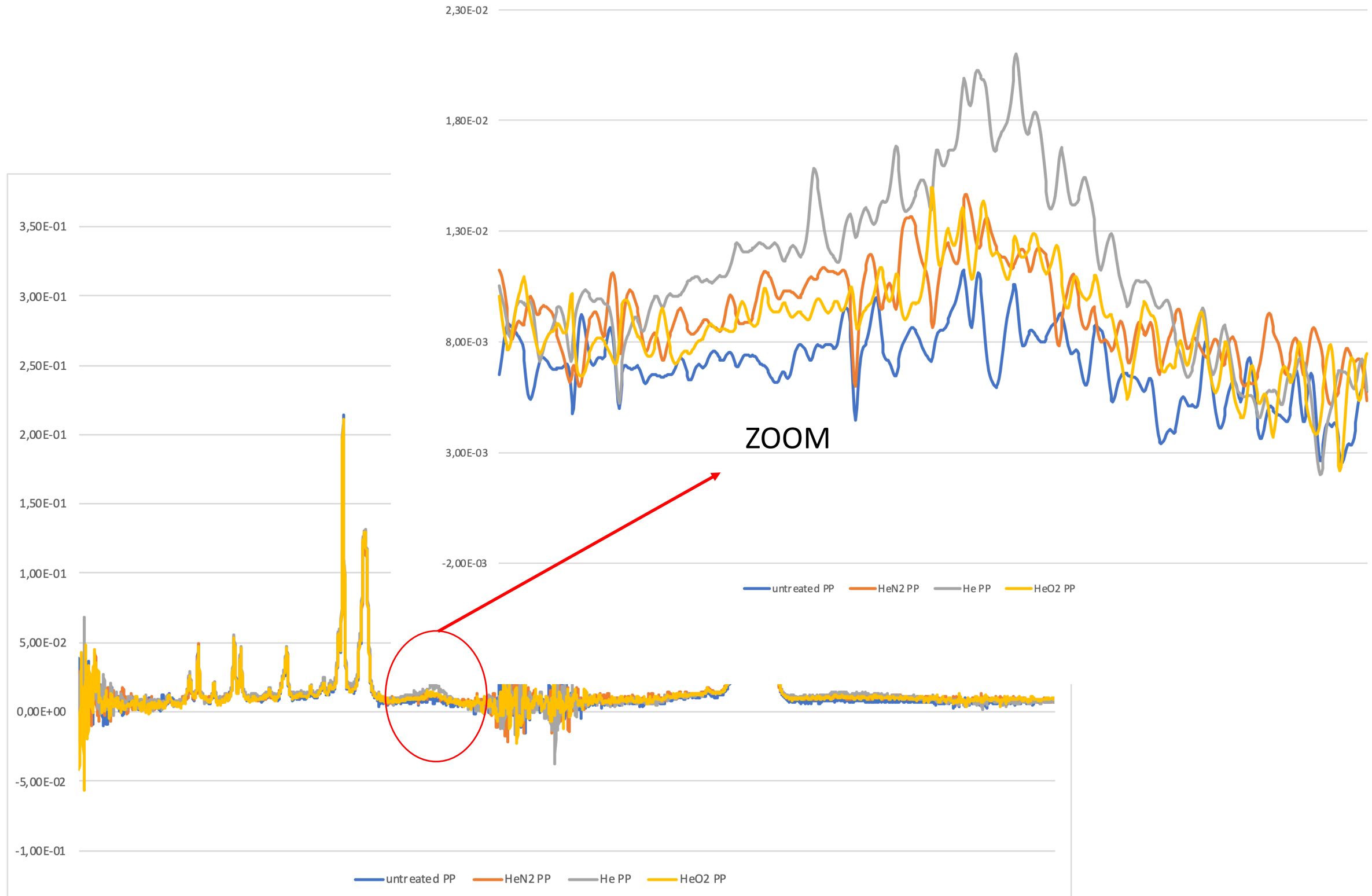

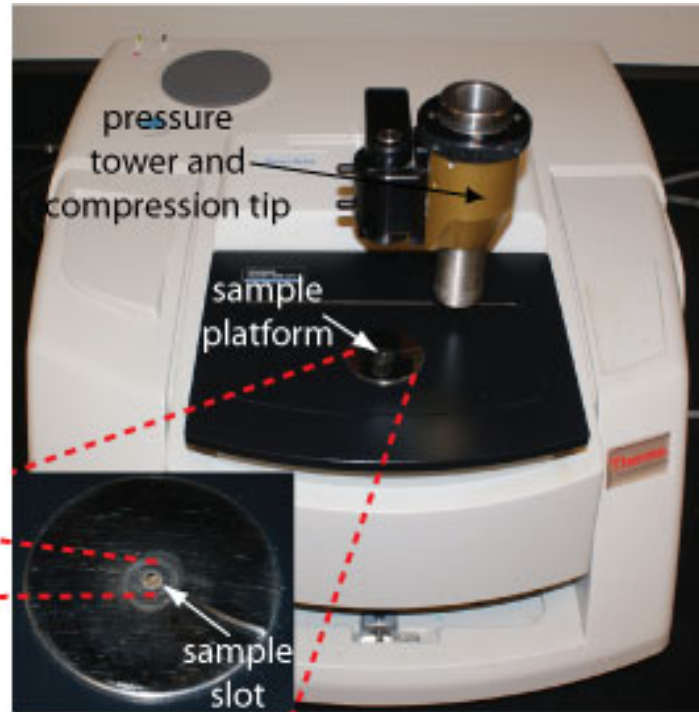
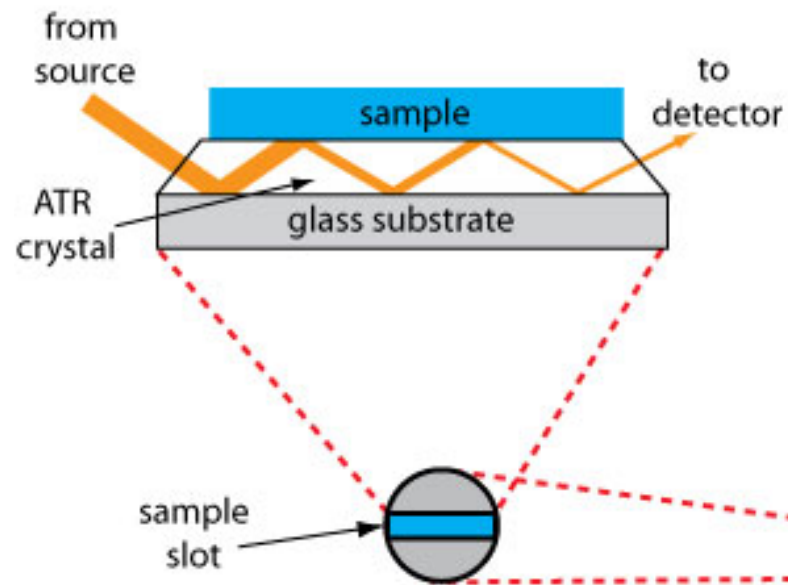

IR ATR is a simple method to follow qualitatively surface oxydation

As well as wetabilty analyses

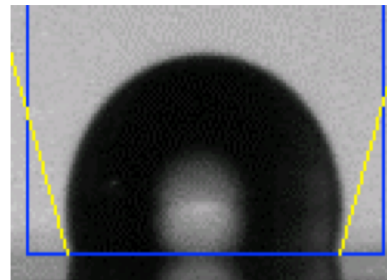

Before plasma exposure



After plasma exposure

But ...

chemical characterizations are needed (XPS)

Surface aging must be controlled, which is linked to the gaseous media in which the samples are stored!

Work in progress...

Steel processing tests

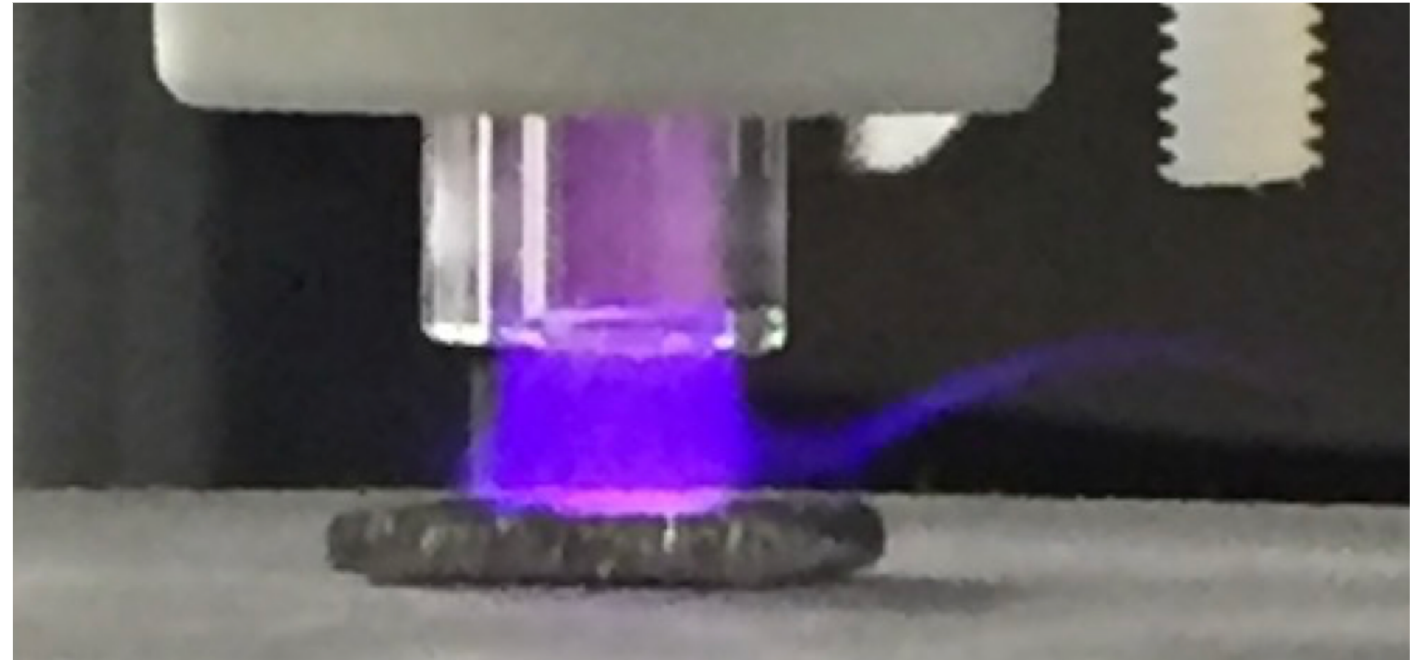
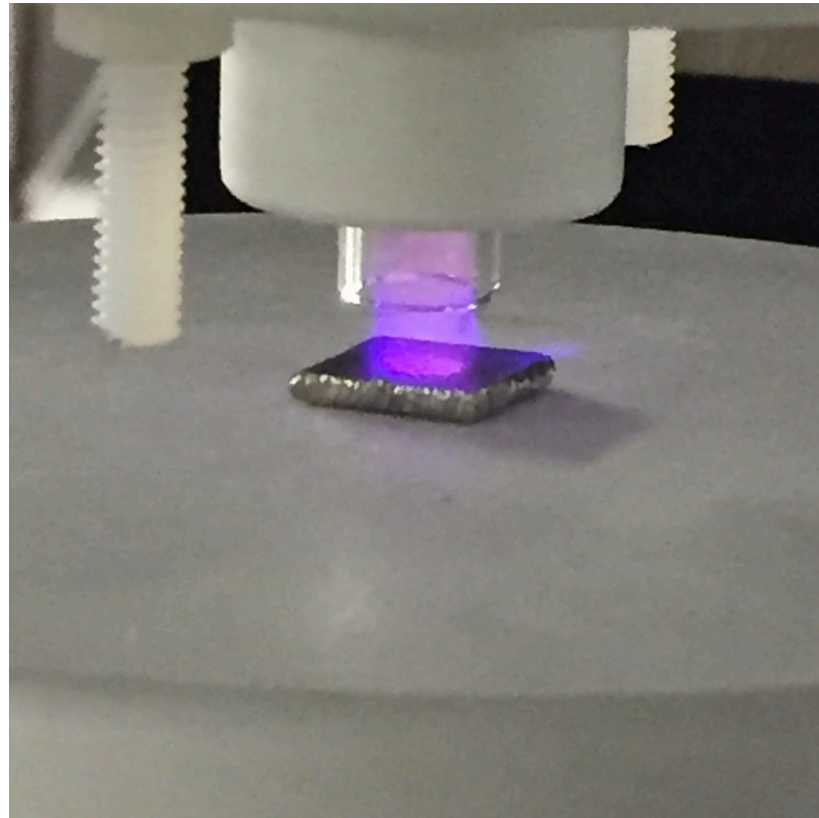

The plasma bounces on the surface

First wettability tests
Water drop spreading

Cleaning ?

Work in progress...

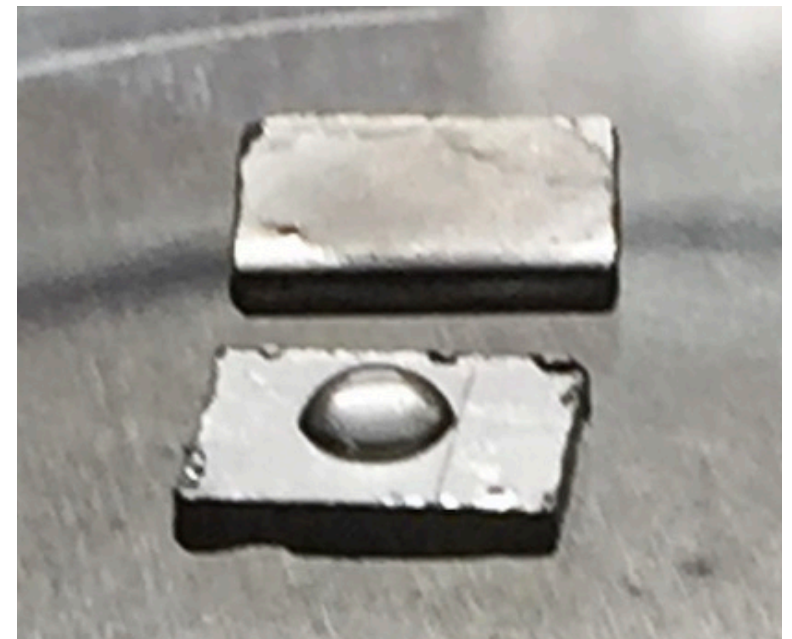

CONCLUSION

Ionization waves produced at atmospheric pressure are very interesting processes for the production of reactive species useful for biomedical applications

Discharges mechanisms have to be studied for the production of these reactive species: charges, radicals and excited states, photons

Electrochemistry methods are very useful to follow the production of chemical species produced in liquids during plasma exposures

The control of the environments (gas and liquid) is capital for a better understanding of the interactions mechanisms between plasmas and liquids or solid materials

Finally

« Garbures » are complex to analyse and difficult to reproduce, but we love to cook and we can sometimes find new recipes !



le ragoût de pattes de cochon
« pig's leg stew »



The « POUTINE »

Merci

To the organising committee
To Cora Roy for her help and
of course to Diego Mantovani



and **THANK YOU FOR YOUR ATTENTION**