



HAL
open science

Design Optimization of a Multi-Temperature Solar Thermal Heating System for an Industrial Process

Amine Allouhi, Younes Agrouaz, Mohammed Benzakour Amine, S. Ur Rehman, Mahmut Sami Bükler, Tarik Kousksou, Abdelmajid Jamil, Ali Benbassou

► **To cite this version:**

Amine Allouhi, Younes Agrouaz, Mohammed Benzakour Amine, S. Ur Rehman, Mahmut Sami Bükler, et al.. Design Optimization of a Multi-Temperature Solar Thermal Heating System for an Industrial Process. *Applied Energy*, 2017, 206, pp.382-392. 10.1016/j.apenergy.2017.08.196 . hal-02153368

HAL Id: hal-02153368

<https://univ-pau.hal.science/hal-02153368>

Submitted on 29 Apr 2024

HAL is a multi-disciplinary open access archive for the deposit and dissemination of scientific research documents, whether they are published or not. The documents may come from teaching and research institutions in France or abroad, or from public or private research centers.

L'archive ouverte pluridisciplinaire **HAL**, est destinée au dépôt et à la diffusion de documents scientifiques de niveau recherche, publiés ou non, émanant des établissements d'enseignement et de recherche français ou étrangers, des laboratoires publics ou privés.

Design optimization of a multi-temperature solar thermal heating system for an industrial process

A. Allouhi^{a,*}, Y. Agrouaz^{a,b}, Mohammed Benzakour Amine^c, S. Rehman^d, M.S. Buker^e,
T. Kousksou^b, A. Jamil^a, A. Benbassou^a

^a Ecole Supérieure de Technologie de Fès, U.S.M.B.A., Route d'Imouzzer, BP 242, Fez, Morocco

^b Laboratoire des Sciences de l'Ingénieur Appliquées à la Mécanique et au Génie Electrique (SIAME), Université de Pau et des Pays de l'Adour – IFR – A. Jules Ferry, 64000 Pau, France

^c Faculté des Sciences et Techniques de Fès, U.S.M.B.A., Route d'Imouzzer, BP 2202, Fez, Morocco

^d Center for Engineering Research, King Fahd University of Petroleum and Minerals, Dhahran 31261, Saudi Arabia

^e Department of Aircraft Engineering, Necmettin Erbakan University, Konya, Turkey

Presently, great challenges are being faced by the industrial sector in terms of energy management and environmental protection. Utilization of solar energy to meet a portion of heat demand in various industries constitutes tremendous economic opportunities for developing countries such as Morocco. Therefore, this paper introduces an optimization procedure and simulation of a centralized solar heating system providing hot water to four processes with different temperature levels and load profiles. As a case study, a Casablanca based Moroccan milk processing company is evaluated and the life cycle cost method is practiced to select the optimal size of the main design parameters for decision-making. It was found that 400 m² of evacuated tube collectors tilted at an angle of 30° and connected to a 2000 l storage tank can lead to a maximum life cycle saving cost of 179 kUSD for a total annual heat demand of 528.23 MWh. In this optimal configuration, the overall annual solar fraction is found to be 41% and the payback period of 12.27 years attained. The system has the potential to reduce around 77.23 tons of CO₂ equivalents of greenhouse gas emissions annually. The economic competitiveness of the solar thermal heating plant can be considerably improved with higher inflation rates and lower initial investments.

1. Introduction

The global energy map is changing, but further efforts must be scaled up to pilot the global energy system towards a more sustainable path. Currently, the major source of energy comes from fossil fuels and unfortunately oil, coal, and natural gas are being used mostly by industrialized and developing countries [1]. By 2035, the global energy demand is expected to rise by more than one-third and the conventional

energy resources will remain under rising pressure [2]. Together with the environmental problems such as adverse climate changes and global warming, this trend will continually force the global community for serious energy reforms.

Industries are the most energy-intensive consumers in nearly all countries. The industrial sector accounts for approximately 50% of the world's energy consumption and causes 36% of energy related greenhouse gas (GHG) emissions [3]. According to the estimates given by the

* Corresponding author.

E-mail address: allouhiamine@gmail.com (A. Allouhi).

Nomenclature

A_c	collector area [m ²]
ALCC	annual life cycle cost [USD]
ALCS	annual life cycle savings [USD]
c_p	specific heat at constant pressure [J/kg K]
d	market discount rate
f	solar fraction
FC	first year fuel cost [USD]
FCU	fuel cost utilization [USD]
F_R	collector heat removal factor
G_t	solar radiation [W/m ²]
i	inflation rate
IC	investment cost [USD]
MC	maintenance cost [USD]
\dot{m}	mass flow rate [kg/h]
n	number of years
PB	payback time [year]
PWF	present worth factor
Q	heat [J]
T	temperature [°C]
t	time [s]
U_L	heat loss coefficient [W/m ² ·K]
U	global heat transfer coefficient [W/m ² ·K]
V	volume [m ³]

Greek letters

η	collector efficiency
$\tau\alpha$	transmittance–absorbance product
η_b	boiler efficiency
ρ	density [kg/m ³]

Subscripts

a	ambient
H	hot water
L	load
i	number of segment
c	collector
o	outlet
fo	fuel only
in	inlet
sol	solar
aux	auxiliary
$loss$	losses

Abbreviations

GDP	gross domestic product
IAP	Industrial Acceleration Plan
STC	solar thermal collectors
USD	United State Dollar

US Energy Information Administration (EIA), energy consumption in the industrial sector is projected to rise by 56% between 2010 and 2040 [4]. Along with all these total figures, heat production is responsible for 37% of energy consumed mainly in developed countries, and 47% of the world's total energy consumption [5]. As a result, valuable efforts have been deployed to limit excessive energy usage in various industrial applications [6,7].

Among all the renewable energy sources, solar energy has gained considerable attention as the promising option for hot water production in industrial sectors [8,9]. Apparently, solar thermal technologies can fulfill a substantial amount of heat demand in these industrial sectors within any country, irrespective of its geographical location [10,11]. These solar thermal systems, for domestic and service applications, are continuously observing increasing market shares across Europe [12]. Nevertheless, solar heat for industrial processes is in an early stage of market development [13]. Hot water, steam, preheating, drying, dehydration processes, concentration, sterilization, cleaning, chemical processes, space heating, food processing, plastic, paper, and textile industries are the most important likely commercial and industrial uses and applications of solar thermal energy among others [14–17]. The amount of thermal energy required in most of the industrial production processes is below 250 °C which is a temperature level that could be easily provided by currently commercially available and marketed solar thermal technologies [18].

Morocco, with a considerably flourishing and growing industrial segment, has recently launched the new Industrial Acceleration Plan (IAP) that will extend to 2020. This plan aims to create half a million jobs in the industrial sector and substantially increase the share of industry in the Gross domestic product (GDP) from the current share of 14% to 23% in the upcoming years [19]. Currently, Morocco imports almost 96% of its energy requirements and experiences an average annual growth of 7% in energy demand [20,21]. From a solar energy perspective, Morocco has abundant solar resources with a potential of 2600 kWh/m²/year and about 3000 h of sunshine per year [22].

The use of solar thermal energy in Morocco is principally limited to conventional hot water production in the building sector [23]. Despite

the fast development of solar water-heating systems for domestic purposes, the application of solar heat to industrial processes is still scarce in Morocco and other developing countries as well. In this context, this work deals with the technical and economic viability of solar industrial process-heating systems for the Moroccan industry.

With regards to solar heating system utilization in the industrial sector, several research attempts has been reported in the literature. The recent studies published on the present topic has been reviewed and reported as following. Atkins et al. [24] studied the possibility of integrating an evacuated tube solar thermal system to generate a part of the process heat demand of a New Zealand milk powder production firm. The benefits of several integration strategies, including mass were analysed. They reported important savings in both hot and cold utilities when mass integration was applied together with solar thermal integration. Lauterbach et al. [25] conducted a study for the implementation of a solar process heat system in a German brewery based on measured data model simulation results. Possible faults that may occur in the solar thermal system were identified and their impact on its performance was evaluated. Walmsley et al. [26] introduced three general scenarios for the integration of industrial solar heating into a Heat Recovery Loop (HRL). A large multi-plant dairy was considered as a case study and the results indicated that arranging the solar collector in series could increase the time average solar heating target from 1.0 MW to 2.3 MW compared to the conventional parallel arrangement. Walmsley et al. [27] compared conventional HRL design method based on a CTS (constant temperature storage) and a new HRL design method using VTS (variable temperature storage) to estimate the possible gains of inter-plant heat integration and implementing solar heating. These methods were practiced for a dairy process. It was reported that, for the same minimum temperature, the VTS approach reached 37% more heat recovery compared to the CTS approach. Fernández-García et al. [28] numerically addressed the specific design of a small-sized industrial parabolic trough collector. The effect of including a flat glass aperture cover was checked to evaluate the thermal performance of the design option. Among three cases studied, it was highlighted that the collector design with a flat glass aperture cover has the highest thermal losses.

The authors also concluded that thermal insulation on the back side of the reflector was not suitable. Quijera et al. [29] examined the feasibility of integrating a solar thermal system to a dairy plant located in the Atlantic side of Spain. The study was based on a mathematical model and a pinch analysis was performed to carry out the solar subsystem integration. The results revealed that the solar system could induce considerable energetic gain if the process was set to operate at low and middle temperatures. Nemet et al. [30] proposed a new methodology for solar heat integration for batch processes based on Time Slices. According to the study, it was possible to determine the amount of solar thermal energy needed for a process and optimize the Time Slices with assumed constant solar thermal energy supply. The examined case study showed that the demand for a utility with constant availability could be reduced by up to 27% by using solar thermal energy directly, without any storage and could reach up to 42% by introducing thermal energy storage as well. Two novel curves (Captured Solar Energy Curve (CSEC), and Minimal Capture Temperature Curve (MCTC)) were developed by Nemet et al. [31]. A trade-off between the captured solar thermal energy and maximal energy delivered to the process was obtained. The application of the proposed curves to integrate solar thermal within a case study has shown the potential of reducing fossil fuel consumption about 373 kW. Bühler et al. [32] investigated a modeling and optimization of a solar thermal system integrated to a dairy industrial process. The results derived from the study showed that integrating such a system could achieve substantial reduction in the operating cost of the dairy factory by a rate of 9% and attain a payback time of 5.5 years. Calderoni et al. [33] presented three techno-economic feasibility studies for textile industry in Tunisia. The study concluded that the solar thermal systems are not yet economically competitive due to highly subsidised fuel provided by the Tunisian government. Vargas-Bautista et al. [34] analysed two concentrations of ethanol at the feed stream (5 wt.% and 10 wt.%) to obtain a distillate product of 95 wt.% ethanol for Monterrey in México by employing evacuated tube and parabolic trough collectors. The results indicated that an energy savings of 80% and 71% could be obtained for 5 wt.% and 10 wt.% ethanol at the feed stream, respectively.

Among the several studies that have been carried out on this subject, this communication has reported a few cases in which the industrial process employs hot water for a single application according to one load profile and one set-temperature. However, at the practical level, most of the industrial processes require hot water simultaneously for various processes. Therefore, the unique feature of this work is to study the potential use of solar thermal energy within an industrial heating activity requiring heat at various water temperatures conforming to different load profiles. Such configuration appears to be more realistic in line with practical applications and to date, there is not any study in literature yet to have treated the economic viability for such cases. Moreover, the case study concerns a developing country with a huge solar energy potential and accelerating industrial growth in which such applications can save important quantities of fossil fuels. In this vision, the present research explores the utilization of a centralized solar water heating plant within a Moroccan food industry to supplement the existing fuel-oil powered boilers. The proposed configuration has shown the potential capability of providing hot water to four industrial processes operating at different temperatures and daily load profiles. Comparing the methodology of the current work to the relevant investigations discussed in [24–32], the novelty is that the optimization procedure to select the best size of the system components is carried out along with practicing LCCA approach considering detailed hourly simulations.

The annual performance of the optimized system is discussed further with its economic and environmental viability. This work can, therefore, serve as a decision support tool for similar processes, especially in developing countries enjoying high solar energy potentials.

2. Overview of industrial solar heating applications

Solar energy can be employed to fulfill a considerable portion of heat demand in relevant industrial sectors. A number of experimental investigations in the literature have shed light on their suitability in several residential, commercial and industrial applications [35,36]. Kaçan et al. [37] analysed the influence of outside, inside temperatures, solar radiation on the horizontal surface and instantaneous efficiency of solar collector on the energetic, exergetic and environmental efficiencies of Solar Combisystems. The results derived from this study proved that the outside temperature, solar radiation and instantaneous efficiency of solar collector were the decisive parameters for all responses. The optimum value of the outside temperature and solar radiation were found to be 22 °C and 773 W/m² for all responses. Napolini et al. [38] discussed the viability of a low-cost domestic solar water heating system for low-income dwellings. It was demonstrated that the economies were considerable in terms of energy consumption and peak demand reduction compared with higher income users of solar water heating technologies. In this respect, readers are encouraged and referred to recent papers [39–48] for further understanding of solar water heating technology and case studies in different climatic conditions.

Thermal energy generation via fossil fuel burning technologies is commonly applied by industries. According to recent estimations, approximately 30% of the total industrial heat demand is required at temperatures below 100 °C and 57% below 400 °C [49]. Relative temperature ranges required for various industrial processes are listed in Table 1 [50]. It is undeniably obvious that using solar energy for heating purposes in the industrial sector is of a great interest due to the

Table 1
Temperature ranges for different industrial processes [50].

Industry	Process	Temperature (°C)
Dairy	Pressurisation	60–80
	Sterilisation	100–120
	Drying	120–180
	Concentrates	60–80
	Boiler feed water	60–90
Tinned food	Sterilisation	110–120
	Pasteurisation	60–80
	Cooking	60–90
	Bleaching	60–90
Textile	Bleaching, dyeing	60–90
	Drying, degreasing	100–130
	Dyeing	70–90
	Fixing	160–180
	Pressing	80–100
Paper	Cooking, drying	60–80
	Boiler feed water	60–90
	Bleaching	130–150
Chemical	Soaps	200–260
	Synthetic rubber	150–200
	Processing heat	120–180
	Pre-heating water	60–90
Meat	Washing, sterilisation	60–90
	Cooking	90–100
Beverages	Washing, sterilisation	60–80
	Pasteurisation	60–70
Flours and by-products	Sterilization	60–80
Timber by-products	Thermo-diffusion beams	80–100
	Drying	60–100
	Pre-heating water	60–90
	Preparation pulp	120–170
Bricks and blocks	Curing	60–140
	Preparation	120–140
Plastics	Distillation	140–150
	Separation	200–220
	Extension	140–160
	Drying	180–200
	Blending	120–140

fact that it will not only reduce the dependency on fossil fuel resources but will also mitigate greenhouse emissions [51].

Although numerous industrial processes have been identified with favorable conditions for the application of solar thermal energy, a particular attention, in this work, is principally dedicated to processes belonging to food industry. These processes are briefly discussed as follows:

2.1. Cleaning processes

Washing and cleaning processes do exist in practically all industrial and commercial sectors. These processes usually take place in the food industry (bottles, barrels, and other containers), in the metal processing industry (metal parts, surfaces prior to varnishing, galvanizing, and enameling), and in the textile industry and laundries as well [50]. Consequently, the use of solar energy for water heating in such processes offers an excellent opportunity and untapped potential towards a sustainable future. In fact, hot water for cleaning is generally required at temperatures between 40 and 90 °C, which can be easily provided by flat plate or vacuum tube collectors [18]. Thus, the appropriate configuration of a solar water heating system for cleaning purposes is key. Usually it is open-system without heat recovery since the cleaning water is generally contaminated and cooled down during the cleaning process [12].

2.2. Drying and dehydration processes

Drying (or dehydration) is the process of removing excess water (moisture) from a natural or an industrial product to preserve or to keep its specified moisture content. The drying process requires significant amount of energy especially if it is used for drying the food products. Generally, the food products have higher water content of about 25–80% more than that for long term preservation [52]. Clearly, this process can be done through numerous thermal methods such as cans, ovens, rotary, flash, dehumidification and spray dryers through solar thermal energy. The operating temperatures for drying food products are generally below 100 °C. But for particular reasons, the process temperature is above 200 °C in applications such as spray drying operated in milk processing. The drying medium, in this process, is

generally warm air and is heated by water/air heat exchangers [51]. The selection of the solar thermal collectors depends on the type of process and amount of heat required. In most cases, flat plate collectors are sufficient, but for higher temperatures, evacuated tubes and concentrated collectors are employed.

2.3. Concentration processes

Concentration is a fundamental process across a wide range of applications in the pharmaceutical, chemical, and biotechnology industries. Heat (energy) is necessary to eliminate liquid by evaporation to leave a concentrated (or dry) product. By comparing with dehydration processes, concentration processes usually consume the same amount of energy. Ordinarily, concentration processes require temperatures ranging from 50 °C to 100 °C [50]. In case of vacuum concentration, the concentration process requires lower temperature due to low pressure inside the concentrator. Accordingly, the use of solar thermal energy can be appropriate.

2.4. Pasteurization and sterilization

There are several methods of food preservation for longer periods. The three main methods of food preservation by heat are pasteurization, sterilization, and ultra-high temperature (UHT) treatment, respectively. According to these three processes, the required heating temperatures vary from 70 °C to 150 °C depending on the number of factors related to food. Plate heat exchangers are mainly utilized to heat the product to the set-point temperature. The heat transfer medium may be hot water or steam and a regeneration section can be employed to improve the process efficiency. The amount of heat required in pasteurization and sterilization processes can be ensured through evacuated tube collectors.

2.5. Industrial space heating and cooling

Studies related to indoor air quality conditions in industries have highlighted that poor ventilation and very high or low temperatures cause efficiency loss, discontent, increased rates of workplace accidents, dizziness and sickness [53]. Therefore, improving the working

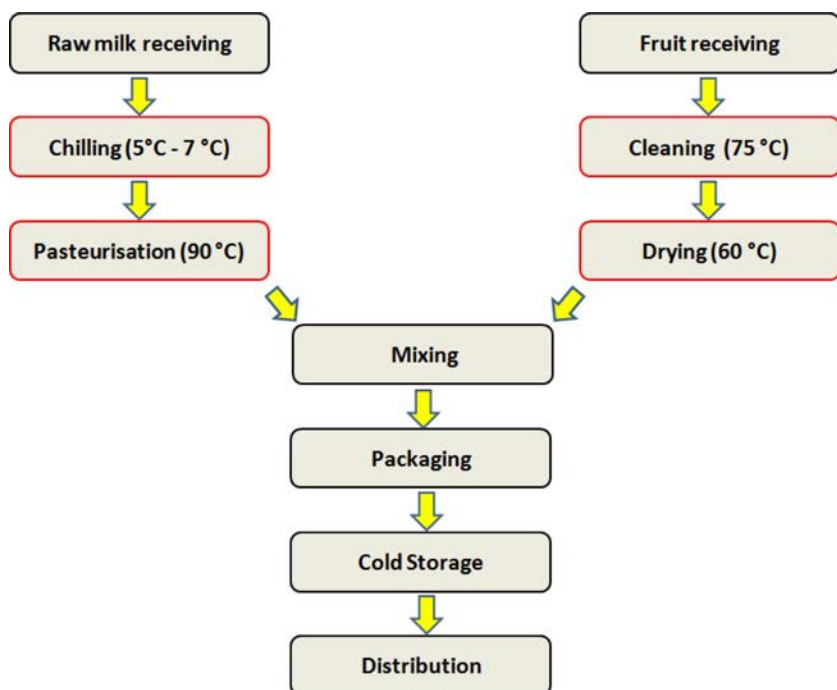

Fig. 1. Manufacturing process used by the industry.

environment and conditions while reducing energy consumption is crucial but a challenging task for industries. Vapor-compression heat pumps are widely employed to heat, cool, ventilate and air condition the working spaces. However, it is found that the mechanical heat pump systems contribute to the depletion of the ozone layer and global warming [54]. An alternative to these conventional systems is the use of solar energy to drive thermal powered heat pumps based on absorption and adsorption processes [55]. These systems have the capability to operate below 100 °C utilizing low grade thermal energy. Therefore, the use of non-concentrating type solar collectors with water as a heat transfer fluid at atmospheric pressure seems to be a viable option [56]. One should note that waste heat recovery could be a competing alternative to solar heating systems in industrial heating processes. Detailed investigations are reported in [57–59].

3. Case study of milk processing industry in Casablanca

Thermal energy plays a pivotal role in the modern food industry. It is required in various processes in order to preserve food products and achieve food safety. Likewise, this is particularly valid for the dairy industry. Milk is surely a favorable breeding ground for pathogenic organisms which may cause several serious diseases. In the case study, the utilization of a centralized solar water heating system in a milk processing industry located in Casablanca (Morocco) is practically investigated. The company produces milk-based mixed and flavored drinks using fruits such as bananas, peaches and strawberries. The manufacturing process is shown in Fig. 1.

The following four main processes that require hot water at different temperature levels and load profiles are listed below:

- (i) Milk chilling (*process 1*): The milk is cooled or chilled to 5–7 °C and stored before processing. The chilling is necessary to avoid rapid multiplication of microorganisms, which prevents the milk from spoilage for a specified period of time. It should be noted that the chilling does not make the milk ready for consumption. The plant employs a high power absorption thermal chiller that is driven by hot water at 80 °C.
- (ii) Fruit cleaning (*process 2*): Received fruits are treated at a temperature of 75 °C at which the aim is to reduce bacteria to safe levels and prevent the contamination of products.
- (iii) Milk pasteurization (*process 3*): This process eliminates nearly all pathogenic germs and makes the milk fit for human consumption. Milk is pasteurized at a temperature of 90 °C.
- (iv) Fruit drying (*process 4*): Before mixing with treated milk, the fruits are dried via water-air heat exchangers. Thus, water must be heated to a temperature of 60 °C.

3.1. Proposed solar system

The proposed solar water heating system is introduced to reduce the energy consumption of the existing fuel-oil based boilers currently in use for hot water production at various temperatures. The proposed system is schematically represented in Fig. 2. It is planned to secure the production of hot water through solar energy and deliver to the four industrial processes described earlier. Each process has specific requirements such as temperature level, water quantity, and period of usage. Table 2 provides a brief information regarding these processes. The proposed system includes array of solar thermal collectors to generate thermal energy from solar radiation. A centralized storage tank is employed to store excess thermal energy and put into use during

Fig. 2. Schematic diagram of the proposed installation.

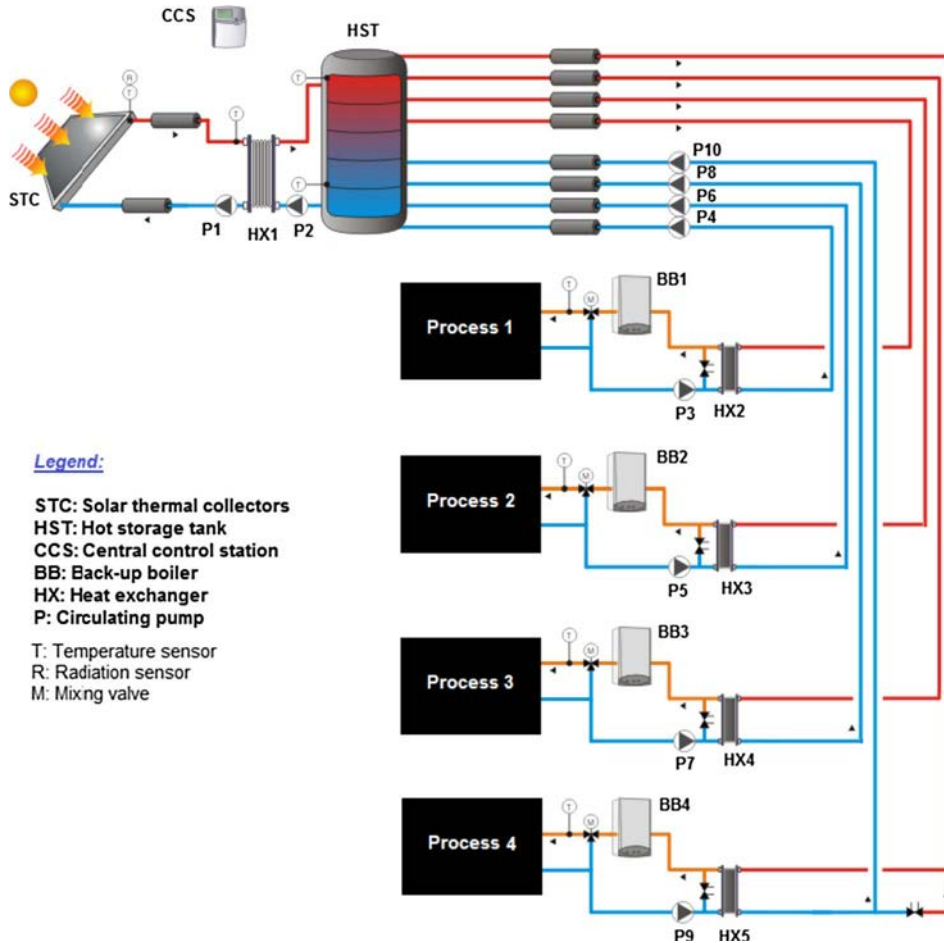

Table 2
Working conditions for each industrial process.

	Process 1	Process 2	Process 3	Process 4
Daily water consumption (m ³)	60	40	50	30
Set-point temperature (°C)	80	75	90	60
Return temperature (°C)	70	70	80	55
Number of working hours	6	3	8	3
Flow stream (kW/°C)	11.62	15.5	7.26	11.62
Number of working days	6	6	6	6

cloudy periods and night time. A series of centrifugal hydraulic pumps for each substation are utilized to circulate water and maintain required flows. At the inlet of each process, there is a backup system running on fossil fuel which complements the solar system when the available solar thermal energy is not sufficient to attain the set-point temperature. The main characteristics of the proposed solar thermal system and its sub-components (solar thermal collectors, hot water storage tank, and the backup boiler) are briefly described as follows:

- **Solar thermal collectors (STC):** As previously stated, the system must be capable of optimally contributing to the heating requirements of the industrial plant (in this case the milk processing plant) by supplying hot water to four different processes and applications. The decision-making for the optimal choice of solar collector technology is a key and takes place by considering both technical and economic aspects of the system. In general, stationary collectors are used in similar applications characterized by low enthalpies. As for the Moroccan market of solar equipment, it is mostly dominated by flat plate and evacuated tube collectors that are currently experiencing high technical advancements and more competitive costs. In comparison to the flat plate collectors, the advantage of evacuated tube collectors lies essentially in their capacity of reaching higher output temperatures under the same solar radiation conditions and leading to smaller installed area requirements. Accordingly, this technology is exploited in the present simulation work.
- **Hot storage tank (HST):** A centralized vertical water storage tank is engaged to store thermal energy and convey to the running processes when there is a shortage in available solar thermal energy to meet the demand. The evacuated tube solar collectors transfer thermal energy captured to the solar storage tank via an external heat exchanger (HX1). Primary and secondary pumps (P1 and P2) are linked to circulate and maintain the fluid flows through the solar thermal collectors and the solar storage tank sides.
- **Backup boiler (BB):** This industrial equipment is required to work continuously in order to prevent interruption in the manufacturing process that may lead to heavy financial losses. Therefore, a backup boiler is connected in series with the storage tank as an auxiliary system to the solar thermal loop to maintain the required temperature at desired level in case there is shortage of solar thermal energy due to clouds or some other meteorological event. The existing boilers in the milk processing plant are still in use, hence they were exploited as a back-up for the solar system rather than investing new ones to minimize the total initial investment cost.

Two control loops manage the system operations. The first loop activates the pump (P1) of the primary solar circuit (STC and HX1) as a function of the incident radiation received in the plane of the solar collectors. This is measured by a radiation sensor. If the incident solar radiation on the collector surface is higher than a value of 300 W/m², then P1 is activated. When the incident solar radiation is lower than a value of 250 W/m², then P1 is stopped.

The second loop control concerns the secondary circuit (HX1 and HST). It is interlinked with the primary control and uses a differential control function that compares the temperature in the hot side of the heat exchanger with the bottom of the solar tank. It generates a control

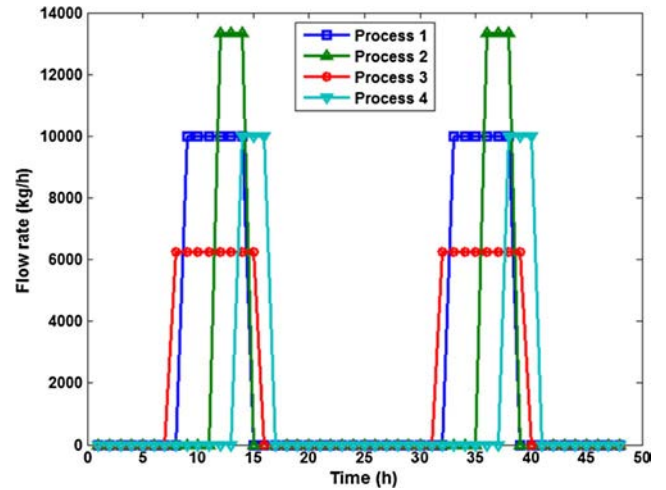

Fig. 3. Load profile for the four processes.

function according to the measured temperatures and two defined dead band temperature differences. The upper dead band temperature difference was set to 13 °C while the lower dead band temperature difference was set to 9 °C, respectively.

No priority is given to any of the processes. Each is supplied with solar thermal energy as required according to set-temperature. The connected back-up boiler is ON once the target temperature is not reached.

3.2. Load profile

The daily water consumption, required temperatures, number of working hours and days are summarized in Table 2. The volume of water needed for each process has been determined with respect to the manufacturing characteristics and the recognized quality standards. The load profile is quasi-repeated throughout the year since the quantity of products to be manufactured is supposed to be constant. Fig. 3 illustrates the hot water demand profile for two consecutive days.

3.3. Climatic data

Casablanca (lat. 33°35'17"N and long. 7°36'40"W) is an Atlantic Coastal City located in the central-western part of Morocco. It is the biggest and the most populated city in the country with 4,270,750 inhabitants as per 2014 census. Casablanca is the commercial capital of Morocco and the hub of its industry as well.

Like most metropolitan cities in low and middle income countries, Casablanca suffers tremendously from air pollution, which exceeds the thresholds according to the World Health Organization (WHO). The latest WHO urban air quality database shows that the annual mean concentration of the particular matter of PM10 should be 20 µg/m³. However, the actual measured PM10 based particulate concentration in Casablanca is 61 µg/m³, which is much higher than it ought to be as stated in WHO guidelines [60]. This discrepancy is mainly caused by industrial emissions.

As for prevailing weather conditions, Casablanca has a typically hot and humid Mediterranean subtropical climate with moderate seasonality [61]. Summers are dry and hot due to the domination of subtropical high pressure systems, while winters are rainy with reasonable moderate temperatures. The annual average precipitation is 412 mm with about 72 annual rainy days. The highest and lowest temperatures ever recorded in the city are 40.5 °C and -2.7 °C, respectively. The monthly mean solar radiation and ambient temperature data in Casablanca are shown in Fig. 4. The solar irradiance increases from January to May and then decreases after July towards the end of the year. Relatively higher values of solar irradiance are observed from May to July.

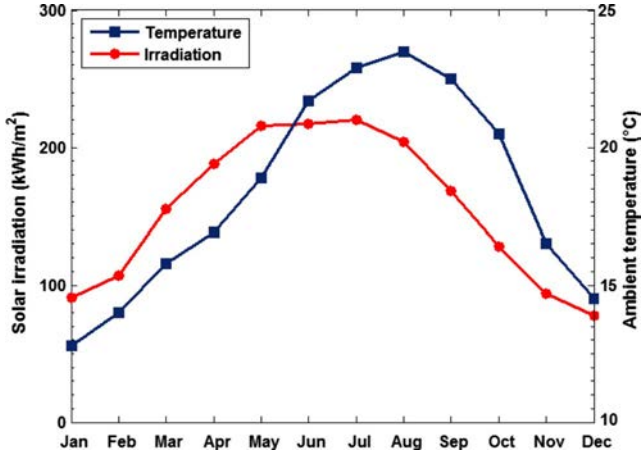

Fig. 4. Monthly solar irradiation and ambient temperature in Casablanca.

The mean temperature values also follow an increasing trend from January to August and then a decreasing tendency towards the end of the year. It is noticed that the peaks in solar irradiance and temperature appeared in July and August, respectively.

4. Methods

TRANSOL, a transient simulation program is employed to study and analyze the dynamic behavior of the solar thermal plant. The governing equations with brief description for each component are presented as follows.

4.1. Mathematical description

4.1.1. Solar thermal collectors

The solar thermal collectors convert the incident solar radiation into useful thermal energy. The rate of useful energy transferred to the fluid is expressed as follows:

$$\dot{Q}_u = \dot{m}c_p(T_o - T_{in}) \quad (1)$$

where \dot{m} is the mass flow rate, c_p is the specific heat of the fluid and, T_{in} and T_o refer to the inlet and the output fluid temperatures, respectively. Using the collector heat removal factor (F_R) and the heat loss coefficient (U_L), the useful rate of energy (\dot{Q}_u) can be expressed by:

$$\dot{Q}_u = A_c F_R [G_i(\tau\alpha) - U_L(T_{in} - T_a)] \quad (2)$$

The term G_i is the incident solar radiation, $\tau\alpha$ is the transmittance-absorptance product and T_a is the ambient temperature, respectively. The thermal efficiency (η) can be determined by dividing the useful rate of energy by the term $A_c G_i$ that presents the rate of energy input as below:

$$\eta = \frac{\dot{Q}_u}{A_c G_i} = \frac{\dot{m}c_p(T_o - T_{in})}{A_c G_i} = F_R(\tau\alpha) - F_R U_L \left(\frac{T_{in} - T_a}{G_i} \right) \quad (3)$$

In reality, the heat loss is not constant but depends linearly on the difference between the inlet and ambient temperatures and is calculated as:

$$F_R U_L = a_1 + a_2(T_{in} - T_a) \quad (4)$$

where a_1 and a_2 denote thermal loss parameters. Replacing this expression in Eq. (3), the thermal collector efficiency can be re-arranged as follows:

$$\eta = \eta_0 - a_1 \frac{(T_{in} - T_a)}{G_i} - a_2 \frac{(T_{in} - T_a)^2}{G_i} \quad (5)$$

In the above equation, η_0 is the collector optical efficiency. The technical specifications of the solar thermal collectors are listed in Table 3.

4.1.2. Storage tank model

Storage tank plays a major role in the system performance. The energy balance equation provided to describe a fully stratified storage tank for each segment (i) reads as follows:

$$\rho V_i c_p \frac{dT_i}{dt} = \dot{Q}_H - \dot{Q}_L - \dot{Q}_{loss} + \gamma_i c_p \Delta T_\gamma \quad (6)$$

where ρ is the water density, V_i is the water volume in the i-th segment, T_i is the temperature of the i-th tank segment. The thermal energy exchanged with the thermal collector field is calculated by:

$$\dot{Q}_H = \dot{\alpha}_i m_H c_p (T_H - T_i) \quad (7)$$

where α_i is equal to 1 if the i-th segment corresponds to the top of the tank, and 0 otherwise. T_H is the temperature of the fluid coming from the heat source and entering the storage tank. The energy utilized by the load is determined by:

$$\dot{Q}_L = \dot{\beta}_i m_L c_p (T_i - T_L) \quad (8)$$

The coefficient β_i takes the value of 1 if the i-th segment corresponds to the bottom of the tank, and 0 otherwise. T_L stands for the temperature of the fluid entering the tank to replace the consumed water by the load. The energy loss to the surroundings is expressed by:

$$\dot{Q}_{loss} = U A_i (T_i - T_a) \quad (9)$$

The remaining term of Eq. (6) is represented as follows:

$$+ \gamma_i c_p (T_{i-1} - T_i) \quad \text{if } \gamma_i > 0$$

$$+ \gamma_i c_p (T_i - T_{i+1}) \quad \text{if } \gamma_i < 0$$

where γ_i is a control function and is defined by:

$$\gamma_i = \dot{m}_H \sum_{j=1}^{i-1} \alpha_j - \dot{m}_H \sum_{j=i+1}^N \beta_j \quad (10)$$

4.1.3. Auxiliary boilers

The auxiliary boilers supply a certain amount of heat to the fluid when the solar system is unable to reach the set point temperature of the load. The energy rate delivered by the auxiliary system can be computed by using the following expression:

$$\dot{Q}_{aux} = \dot{m}_L c_p \Delta T_L \quad (11)$$

where ΔT_L is the difference between the fluid temperature needed by the load and the fluid temperature supplied by the solar loop.

4.2. Economic analysis

In this study, Annual Life Cycle Cost (ALCC) analysis is carried out for the financial evaluation of the solar heating process [62]. The principal aim of the design optimization is to obtain the maximum life-cycle net energy savings by identifying the optimal combination of the collector area and the storage volume. This method is principally based on the prediction of future costs approach. Moreover, the main feature of this method is that all anticipated expenses are discounted to a present-day value. The life-cycle cost is the sum of all the present worth. In order to assess the economic benefits of the proposed solar thermal heating system, the Annual Life Cycle Savings (ALCS) is the first step to

Table 3
Technical specifications of the thermal collector.

Parameter	Value	Unit
η_0	0.630	[-]
a_0	1.24	[W/m ² ·K]
a_1	0.009	[W/m ² ·K ²]
Unit area	1.9	[m ²]

be considered. So, the expression of the ALCS is given by:

$$ALCS = ALCC_{fo} - ALCC_{sol} \quad (12)$$

where $ALCC_{fo}$ and $ALCC_{sol}$ refer to the annual life cycle costs related to the fuel-only system and the solar plus auxiliary energy system, respectively. The ALCC of the fuel-only system can be calculated as:

$$ALCC_{fo} = FC \times Q_{load} \times PWF \quad (13)$$

where FC is the first-year fuel cost, Q_{load} denotes the total thermal energy required by the load (kWh) and PWF is the present worth factor of series of inflating payments that can be estimated by:

$$PWF = \frac{1}{d-i} \left[1 - \left(\frac{1+i}{1-d} \right)^n \right] \quad (14)$$

where d is the market discount rate, n is the number of years and i is the inflation rate. The $ALCC_{sol}$ is obtained by summing the initial investment cost (IC), the maintenance cost (MC) and the cost resulting from the fuel cost utilization (FCU) to assist the solar system:

$$ALCC_{sol} = IC + MC + FCU \quad (15)$$

The initial investment involves the cost of the storage tank, solar collector field and installation as well.

The running costs (MC and FCU) are all brought to a present worth by considering the present worth factor (PWF). It is important to note that the costs of the boilers and their maintenance costs are not taken into account, since the values remain unchanged for the two systems. In addition, the boiler efficiency is considered to be 78.8%. Another economic criterion which is also a crucial parameter to evaluate the economics of the solar system is the payback time. It is the time needed for the cumulative fuel savings to offset initial investment costs. It can be calculated by [22,62]:

$$PB = \frac{\ln\left(\frac{IC \times i}{f \times Q_{load} / \eta_b \times CF} + 1\right)}{\ln(1+i)} \quad (16)$$

All the terms in Eq. (16) have been specified previously except the term η_b which refers to the boiler efficiency, and f which is the annual solar fraction of the proposed system that represents the ratio of the solar contribution to the total load.

Based on the national market considerations and some information provided in the literature, the following assumptions were retained to perform the economic analysis [63–65]:

- First-year fuel cost is taken as 0.071 USD/kWh.
- Annual market discount rate in Morocco is considered as 5%.
- Fuel cost inflation rate is taken as 2.5% per year.
- Average specific cost of hot storage tank is 1060 USD/m³.
- Average specific cost of the solar collector is 265 USD/m².
- Installation cost is taken equal to 1% of the total equipment cost.
- Maintenance cost is 1.5% of the initial investment and is expected to increase at a rate of 0.5% per year.

5. Results and discussion

The monthly mean heating demand for each process is presented in Fig. 5. These results are based on the volume of water needed for each process, set-point temperatures, and general pattern of usage. The stable hot water requirements throughout the year for the present manufacturing activities lead to minor deviations in the heat requirements. Thereby, the heat requirements were found to be varied between 16.76–18.55 MWh for process 1, 5.58–6.28 MWh for process 2, 13.96–15.71 MWh for process 3, and 4.19–4.71 MWh for process 4, respectively. Annually, the solar heating system is expected to provide around 528.2 MWh of thermal energy. The processes 1, 2, 3 and 4 constitute about 41.3%, 13.8%, 34.5% and 10.4% of the total heat demand, respectively.

The method adopted for the optimization of the proposed system begins with the initial design configuration. Followingly, simulations were conducted to determine the optimum configuration in terms of the tilt angle of the solar system, aperture area, and the volume of the storage tank. As for the economic analysis, the objective function in the present case is the ALCS that should be maximized.

Generally, the optimal tilt angle can be decided based on monthly, seasonal, or annual periods. In this study, annual analysis is preferred based on the conclusions drawn by Lima et al. [66]. When the heat demand is practically constant throughout the year, the benefit of monthly and seasonal optimization is marginal. Fig. 6 illustrates the variation of the ALCS (expressed in thousands of USD) according to various collectors' tilt angle values. It can be clearly seen that the maximum ALCS is obtained when the tilt angle is 30°. This value approximately corresponds to the local latitude. In fact, it is recommended by researchers that when the tilt angle is within the range of (latitude ± 5°), there is no major deviation in the ALCS values [50,66]. This practical rule is also practiced by most of the companies installing such systems in Moroccan cities. For this configuration, the maximum ALCS is found to be about 154 kUSD and this broadly accurate guide based on practice allows a better appreciation of solar energy usage and leads to higher energy savings.

Yan et al. [67] in their economic optimization of solar water heating systems concluded that it is more suitable to start by optimizing the collector area before the volume of the hot water tank. Based on this finding, various solar thermal collectors areas ranging from 200 to 600 m² were simulated and the variation of the ALCS corresponding to varied collector areas is displayed in Fig. 7. It should be noted that the collectors were considered tilted at the optimal tilt angle of 30°. The simulation results indicate that increase in collector area significantly effects the cumulative savings. Apparently, the maximum ALCS is attained when the collectors' total area is equal to 400 m². Such an area for solar thermal system can be allocated without difficulty in medium or large food industries that usually occupies spacious sites. So, the number of thermal collectors is 213 covering the area of 400 m². These collectors must be regrouped in such a way to avoid the self-shading by maintaining a sufficient distance between each collector, generally greater than 2 m. This configuration has a potential to reach an ALCS of 179 kUSD. Indeed, the greater the solar thermal collector area, the more heat output the collector produces and contributes to the load and leads to higher energy savings. However, bigger systems will require relatively higher initial investment costs that adversely affects the economic viability of the system.

The final set of simulations, illustrated in Fig. 8, is related to the impact of the hot water storage tank volume on the ALCS. The results show that enlarging the volume of the hot water tank has negative

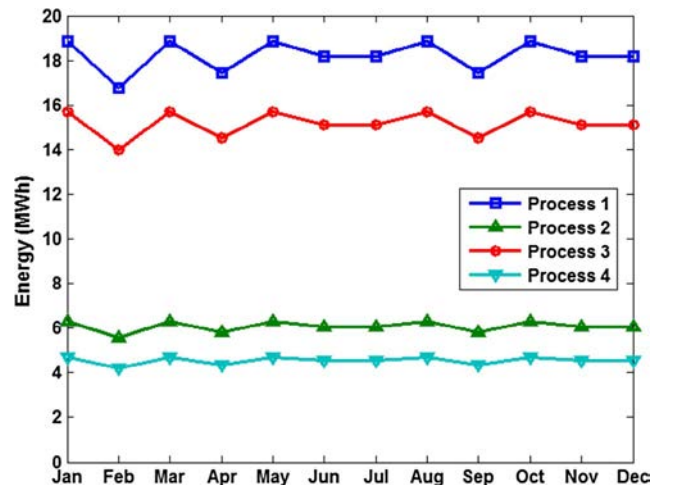

Fig. 5. Energy requirements for each industrial process.

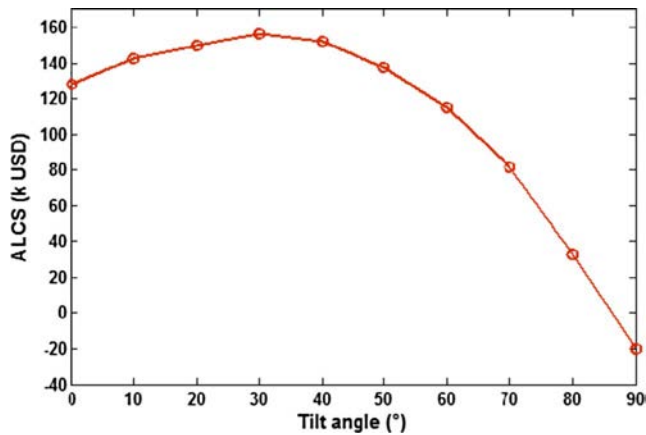

Fig. 6. Variation of ALCS with the tilt angle.

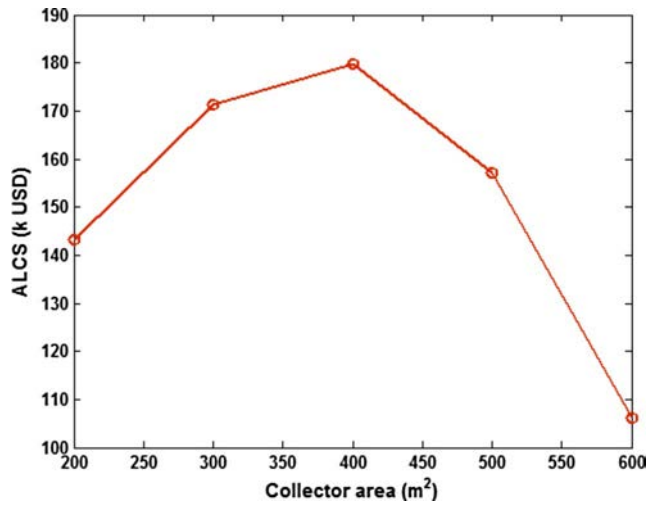

Fig. 7. Variation of ALCS with collector area.

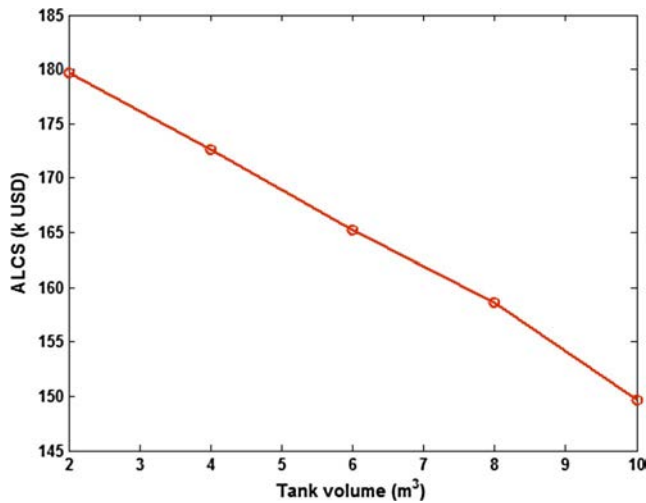

Fig. 8. Variation of ALCS with the storage tank volume.

Table 4
Final system configuration.

Parameter	Value
Tilt angle (°)	30
Total collectors' area (m ²)	400
Storage tank volume (L)	2000
ALCS (kUSD)	179

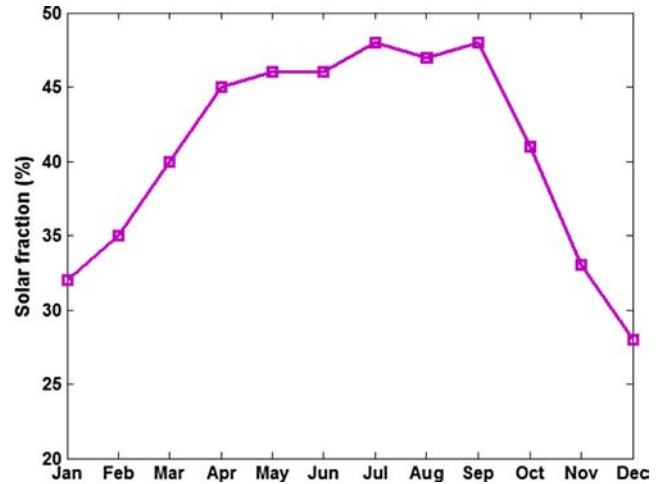

Fig. 9. Monthly solar fractions of the optimized configuration.

Table 5
Annual solar fraction for each process.

Process	Process 1	Process 2	Process 3	Process 4
Annual solar fraction (%)	38.2	73	30.5	66.3

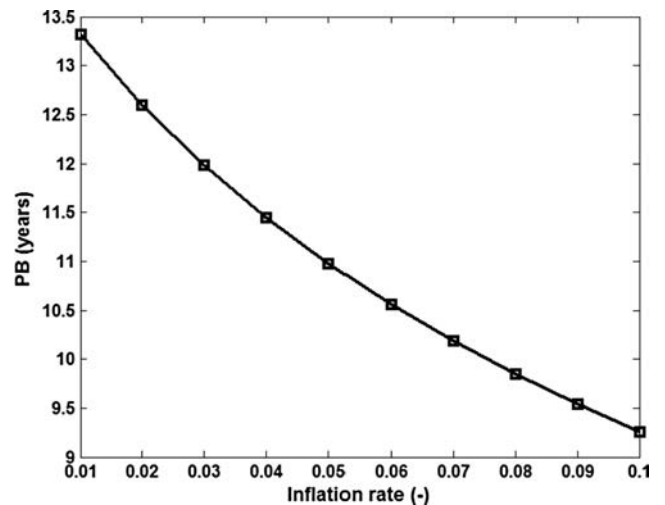

Fig. 10. Effect of the inflation rate on the payback period.

impacts on the life cycle savings of the system. This can be interpreted by the fact that the load profile coincides well with the availability of solar energy. In this case, the storage volume can be minimized. The simulations also demonstrate that increasing the hot water tank volume does not have any considerable effect on the solar fraction of the savings. On the other hand, the system's total cost becomes higher which will eventually result in a negative effect on cumulative life cycle

savings. Thus, it can be concluded that a minimum volume of 2000 l is sufficient to keep the system functional and convenient in operation in this case. It should be noted that the mass flow rate was considered to be 9000 kg/h in the solar loop. The details of the final optimal system configuration is given in Table 4.

The performance characteristics of the optimized configuration is evaluated by considering the monthly net solar fraction of the system (see Fig. 9). As previously stated, the heat demand is approximately constant throughout the year and therefore the main cause for the

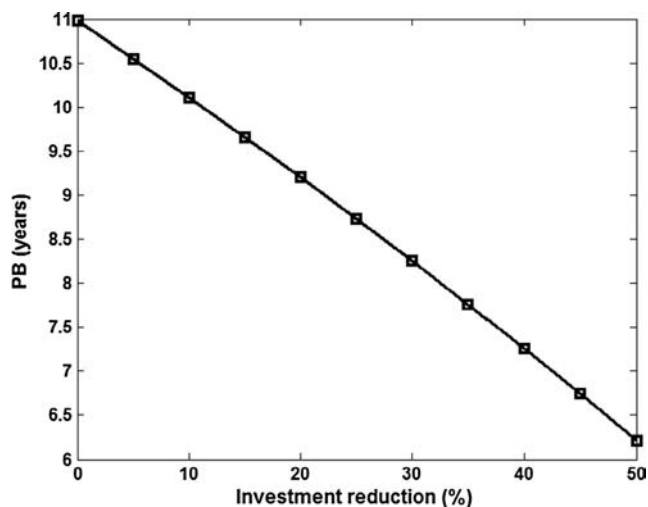

Fig. 11. Effect of decreasing the initial investment on the payback period.

changes in the solar fraction originates from the variability of solar irradiance intensity (see Fig. 4). The lower solar fractions are obviously obtained during the winter period ranging from 28% to 35%. The highest value of the solar fraction is achieved during the months of July and September, meanwhile, insignificant variations are observed during the rest of the summer period (between 45% and 48%). The overall annual solar fraction is found to be 41.01% that corresponds to a net annual energy saving of about 216.62 MWh. Overall annual energy saving is equivalent to 275.85 MWh given that the boiler efficiency of 78.53%. The contribution of the solar system to the heat demand for each one of the four processes in terms of the annual solar fraction is presented in Table 5. The maximum solar fraction is achieved in the processes with the lowest heat demands (process 2 and 4). A minimum solar fraction of 30.5% is obtained for the process 3 that represents 34.5% of the overall heat demand.

Since the solar system will substitute an important part of the fuel consumption, carbon footprint resulting from the thermal energy generation is expected to decline for this industry [68]. By considering the value of carbon dioxide content of fuel-oil equal to 0.28 kg CO₂/kWh [69], a total amount of 77.23 tons of CO₂ equivalent greenhouse gases can be mitigated annually.

The payback period has been obtained based on the current market status (an inflation rate of 2.5%, a total initial investment of 115 kUSD and a fuel cost of 0.071 USD/kWh) and is estimated to be 12.27 years. However, this payback period is subject to change due to market fluctuations. Therefore, sensitivity analysis has been carried out to understand the influence of the inflation rate on the payback period. The results, in Fig. 10, show that an increase of 10% in the inflation rate of conventional energy price may cause a significant decrease in the payback period, i.e. of 9.25 years in this scenario. Furthermore, the reduction of the initial investment cost due to technological advancements and decreasing costs of solar equipment can have a positive effect on the economic viability of the overall system. This trend can be clearly seen in Fig. 11. An inflation rate of 5% with a reduction of the initial investment to a value of 25% can lead to a payback period of only 8.7 years.

6. Conclusion

Harnessing solar thermal energy for industrial heating purposes, especially in developing countries that have abundant source of solar energy, can improve competitiveness, stimulate innovation and lead to many economic and environmental advancements and sustainability. Nevertheless, the system design and integration with the process must be carefully tailored to maintain an optimal operation of the overall

activity and avoid malfunctions. Hence, this work provides a thorough methodology for designing and implementing such a system with the technical details (tilt angle, collector area, the volume of the hot water tank, system configuration, etc.) and assessing economic viability based on the life cycle cost analysis for the real applications. In this context, the proposed system is planned to support the conventional heating system comprising fuel-oil based boilers in a food industry located in Casablanca, Morocco. The concluding remarks are outlined as follows.

The novelty of this study is that the solar system is designed to fulfill heat demand of four different processes operating at various temperatures and load profiles. The hourly simulation of the final configuration derived from the optimization shows that the solar fraction of the proposed design is about 41% and has the potential to ensure a life cycle savings of 179 kUSD considering a system lifespan of 20 years. Moreover, an annual CO₂ emission reduction of 77.23 tons can be achieved by implementing such a system. Also, the system payback period is found to be 12.27 years, but this period is subject to alteration significantly due to higher inflation rates or lower initial investments.

In a nutshell, the performance and economic investigation of the proposed system reveals that a substantial amount of energy can be saved by harnessing solar thermal energy when implementing such an efficient system. This system may also provide a simple yet effective alternative for regions suffering from energy scarcity especially in the commercial areas. Solar thermal systems also provide enormous environmental benefits as they do not incorporate exhaust gases, and mostly do not allow any kind of air emissions or waste products. Thus, these systems may also contribute to mitigation of the environmental pollution and provide a remedial action, especially in the areas where air emissions arise in dangerous levels like in industrialized cities. And the last but not the least, diversified industries, firms and companies may get ideas from this investigation to develop a further plan of action.

Acknowledgments

The authors acknowledge the support provided by the “Institut de Recherche en Energie Solaire et Energies Nouvelles (IRESEN)” under the two projects: SOL'R SHEMA and Solar Cooling Process in Morocco (SCPM).

References

- [1] Song C, Liu Q, Ji N, Deng S, Zhao J, Kitamura Y. Natural gas purification by heat pump assisted MEA absorption process. *Appl Energy* 2017;204:353–61.
- [2] International Energy Agency (IEA). World energy outlook; 2012. <<https://www.iea.org/>> .
- [3] Rahman MS, Noman AHM, Shahari F, Aslam M, Gee CS, Isa CR, et al. Efficient energy consumption in industrial sectors and its effect on environment: a comparative analysis between G8 and Southeast Asian emerging economies. *Energy* 2016;97:82–9.
- [4] Sieminski A. International energy outlook; 2014.
- [5] International Energy Agency. Co-generation and renewables: solution for a low carbon future. International Energy Agency; 2011. <<https://www.iea.org/>> .
- [6] Yang M, Feng X, Liu G. Heat integration of heat pump assisted distillation into the overall process. *Appl Energy* 2016;162:1–10.
- [7] You X, Rodriguez-Donis I, Gerbaud V. Reducing process cost and CO₂ emissions for extractive distillation by double-effect heat integration and mechanical heat pump. *Appl Energy* 2016;166:128–40.
- [8] Mekhilef S, Saidur R, Safari A. A review on solar energy use in industries. *Renew Sustain Energy Rev* 2011;15(4):1777–90.
- [9] Von Storch H, Roeb M, Stadler H, Sattler C, Bardow A, Hoffschmidt B. On the assessment of renewable industrial processes: case study for solar co-production of methanol and power. *Appl Energy* 2016;183:121–32.
- [10] IEA-ETSAP and IRENA© technology brief E21 – January 2015. Solar heat for industrial processes technology brief. <<http://www.etsap.org>> , <<http://www.irena.org>> .
- [11] Ratismith W, Favre Y, Canaff M, Briggs J. A non-tracking concentrating collector for solar thermal applications. *Appl Energy* 2017;200:39–46.
- [12] Stefan heß, Oliva Axel. Solar process heat generation: guide to solar thermal system design for selected industrial processes, FraunhoferISE, Germany. <<http://www.solar-process-heat.eu>> .
- [13] Comodi G, Bevilacqua M, Caresana F, Paciarotti C, Pelagalli L, Venella P. Life cycle assessment and energy-CO₂-economic payback analyses of renewable domestic hot

- water systems with unglazed and glazed solar thermal panels. *Appl Energy* 2016;164:944–55.
- [14] Sharma AK, Sharma C, Mullick SC, Kandpal TC. Carbon mitigation potential of solar industrial process heating: paper industry in India. *J Clean Prod* 2016;112:1683–91.
- [15] Yadav D, Banerjee R. A review of solar thermochemical processes. *Renew Sustain Energy Rev* 2016;54:497–532.
- [16] Lauterbach C, Schmitt B, Jordan U, Vajen K. The potential of solar heat for industrial processes in Germany. *Renew Sustain Energy Rev* 2012;16(7):5121–30.
- [17] Beath AC. Industrial energy usage in Australia and the potential for implementation of solar thermal heat and power. *Energy* 2012;43(1):261–72.
- [18] European Solar Thermal Industry Federation (ESTIF). *Solar industrial process heat – state of the art*; 2006. <http://www.invest.gov.ma>.
- [20] Kousksou T, Allouhi A, Belattar M, Jamil A, El Rhafiki T, Zeraouli Y. Morocco's strategy for energy security and low-carbon growth. *Energy* 2015;84:98–105.
- [21] Kousksou T, Allouhi A, Belattar M, Jamil A, El Rhafiki T, Arid A, et al. Renewable energy potential and national policy directions for sustainable development in Morocco. *Renew Sustain Energy Rev* 2015;47:46–57.
- [22] Allouhi A, Kousksou T, Jamil A, El Rhafiki T, Mourad Y, Zeraouli Y. Economic and environmental assessment of solar air-conditioning systems in Morocco. *Renew Sustain Energy Rev* 2015;50:770–81.
- [23] Allouhi A, Kousksou T, El Rhafiki T, Mourad Y, Zeraouli Y. Solar domestic heating water systems in Morocco: an energy analysis. *Energy Convers Manage* 2015;92:105–13.
- [24] Atkins MJ, Walmsley MR, Morrison AS. Integration of solar thermal for improved energy efficiency in low-temperature-pinch industrial processes. *Energy* 2010;35(5):1867–73.
- [25] Lauterbach C, Schmitt B, Vajen K. System analysis of a low-temperature solar process heat system. *Sol Energy* 2014;101:117–30.
- [26] Walmsley TG, Walmsley MR, Tarighaleslami AH, Atkins MJ, Neale JR. Integration options for solar thermal with low temperature industrial heat recovery loops. *Energy* 2015;90:113–21.
- [27] Walmsley TG, Walmsley MR, Atkins MJ, Neale JR. Integration of industrial solar and gaseous waste heat into heat recovery loops using constant and variable temperature storage. *Energy* 2014;75:53–67.
- [28] Fernández-García A, Rojas E, Pérez M, Silva R, Hernández-Escobedo Q, Manzano-Agugliaro F. A parabolic-trough collector for cleaner industrial process heat. *J Clean Prod* 2015;89:272–85.
- [29] Quijiera JA, Alriols MG, Labidi J. Integration of a solar thermal system in a dairy process. *Renewable Energy* 2011;36(6):1843–53.
- [30] Nemet A, Klemeš JJ, Varbanov PS, Kravanja Z. Methodology for maximising the use of renewables with variable availability. *Energy* 2012;44(1):29–37.
- [31] Nemet A, Kravanja Z, Klemeš JJ. Integration of solar thermal energy into processes with heat demand. *Clean Technol Environ Policy* 2012;14(3):453–63.
- [32] Bühler F, Nguyen T-V, Elmegaard B, Modi A. Process and economic optimisation of a milk processing plant with solar thermal energy. In: Kravanja Z, Bogataj M, editors. *Proceedings of the 26th European symposium on computer aided process engineering*, vol. 38; 2016. p. 1347–52.
- [33] Calderoni M, Aprile M, Moretta S, Aidonis A, Motta M. Solar thermal plants for industrial process heat in Tunisia: economic feasibility analysis and ideas for a new policy. *Energy Proc* 2012;30:1390–400.
- [34] Vargas-Bautista JP, García-Cuellar AJ, Pérez-García SL, Rivera-Solorio CI. Transient simulation of a solar heating system for a small-scale ethanol-water distillation plant: thermal, environmental and economic performance. *Energy Convers Manage* 2017;134:347–60.
- [35] Tulus V, Boer D, Cabeza LF, Jiménez L, Guillén-Gosálbez G. Enhanced thermal energy supply via central solar heating plants with seasonal storage: a multi-objective optimization approach. *Appl Energy* 2016;181:549–61.
- [36] Allouhi A, Kousksou T, Jamil A, Agrouaz Y, Bouhal T, Saidur R, et al. Performance evaluation of solar adsorption cooling systems for vaccine preservation in Sub-Saharan Africa. *Appl Energy* 2016;170:232–41.
- [37] Kaçan E, Ülgen K, Kaçan E. What is the effect of optimum independent parameters on solar heating systems? *Energy Convers Manage* 2015;105:103–17.
- [38] Napolini HF, Militão HSG, Rütther R. The role and benefits of solar water heating in the energy demands of low-income dwellings in Brazil. *Energy Convers Manage* 2010;51(12):2835–45.
- [39] Napolini HF, Rütther R. Impacts of Domestic Solar Water Heating (DSWH) systems on the cost of a hot shower in low-income dwellings in Brazil. *Renewable Energy* 2017;111:124–30.
- [40] Sharma AK, Sharma C, Mullick SC, Kandpal TC. Solar industrial process heating: a review. *Renew Sustain Energy Rev* 2017;78:124–37.
- [41] Rezvani S, Bahri PA, Urmee T, Baverstock GF, Moore AD. Techno-economic and reliability assessment of solar water heaters in Australia based on Monte Carlo Analysis. *Renewable Energy* 2017;105(5):774–85.
- [42] Joubert EC, Hess S, Van Niekerk JL. Large-scale solar water heating in South Africa: status, barriers and recommendations. *Renewable Energy* 2016;97:809–22.
- [43] Zhang B, Fan X, Liu M, Hao W. Experimental study of the burning-cave hot water soil heating system in solar greenhouse. *Renewable Energy* 2016;87:1113–20.
- [44] Zou B, Dong J, Yao Y, Jiang Y. An experimental investigation on a small-sized parabolic trough solar collector for water heating in cold areas. *Appl Energy* 2016;163:396–407.
- [45] Wang Z, Qiu F, Yang W, Zhao X. Applications of solar water heating system with phase change material. *Renew Sustain Energy Rev* 2015;52:645–52.
- [46] Halawa E, Chang KC, Yoshinaga M. Thermal performance evaluation of solar water heating systems in Australia, Taiwan and Japan – a comparative review. *Renewable Energy* 2015;83:1279–86.
- [47] Rehman S, Alhems LM, Lashin A. Solar water heating system performance analysis for industrial applications for Jawf city in Saudi Arabia. *Wulfenia J* 2010;22(12):392–407.
- [48] Ji J, Wang Y, Yuan W, Sun W, He W, Guo C. Experimental comparison of two PV direct-coupled solar water heating systems with the traditional system. *Appl Energy* 2014;136:110–8.
- [49] Vannoni C, Battisti R, Drigo S. Potential for solar heat in industrial processes. *IEA SHC Task* 2008;33:174.
- [50] Kalogirou S. The potential of solar industrial process heat applications. *Appl Energy* 2003;76(4):337–61.
- [51] Schnitzer H, Brunner C, Gwehenberger G. Minimizing greenhouse gas emissions through the application of solar thermal energy in industrial processes. *J Clean Prod* 2007;15(13):1271–86.
- [52] Kalogirou SA. *Solar energy engineering: processes and systems*. Academic Press; 2013.
- [53] Burke MJ. *Applied ergonomics handbook*. CRC Press; 1991.
- [54] Demir H, Mobedi M, Ülkü S. A review on adsorption heat pump: Problems and solutions. *Renew Sustain Energy Rev* 2008;12(9):2381–403.
- [55] Allouhi A, Kousksou T, Jamil A, Bruel P, Mourad Y, Zeraouli Y. Solar driven cooling systems: an updated review. *Renew Sustain Energy Rev* 2015;44:159–81.
- [56] Jaiswal AK, Mitra S, Dutta P, Srinivasan K, Murthy SS. Influence of cycle time and collector area on solar driven adsorption chillers. *Sol Energy* 2016;136:450–9.
- [57] Brückner S, Liu S, Miró L, Radspieler M, Cabeza LF, Lävemann E. Industrial waste heat recovery technologies: an economic analysis of heat transformation technologies. *Appl Energy* 2015;151:157–67.
- [58] Liew PY, Walmsley TG, Alwi SRW, Manan ZA, Klemeš JJ, Varbanov PS. Integrating district cooling systems in locally integrated energy sectors through total site heat integration. *Appl Energy* 2016;184:1350–63.
- [59] Oluleye G, Smith R. A mixed integer linear programming model for integrating thermodynamic cycles for waste heat exploitation in process sites. *Appl Energy* 2016;178:434–53.
- [60] World Health Organization (WHO) <<http://www.who.int/>> [accessed: 09-01-16].
- [61] Kottek M, Grieser J, Beck C, Rudolf B, Rubel F. World map of the Köppen-Geiger climate classification updated. *Meteorol Zeitschrift* 2006;15(3):259–63.
- [62] Duffie JA, Beckman WA. *Solar engineering of thermal processes*. John Wiley & Sons; 2013.
- [63] Eicker U, Colmenar-Santos A, Teran L, Cotrado M, Borge-Diez D. Economic evaluation of solar thermal and photovoltaic cooling systems through simulation in different climatic conditions: an analysis in three different cities in Europe. *Energy Build* 2014;70:207–23.
- [64] Allouhi A, Saadani R, Kousksou T, Saidur R, Jamil A, Rahmoune M. Grid-connected PV systems installed on institutional buildings: technology comparison, energy analysis and economic performance. *Energy Build* 2016;130:188–201.
- [65] Otanicar T, Taylor RA, Phelan PE. Prospects for solar cooling – an economic and environmental assessment. *Sol Energy* 2012;86(5):1287–99.
- [66] Lima TP, Dutra JCC, Primo ARM, Rohatgi J, Ochoa AAV. Solar water heating for a hospital laundry: a case study. *Sol Energy* 2015;122:737–48.
- [67] Yan C, Wang S, Ma Z, Shi W. A simplified method for optimal design of solar water heating systems based on life-cycle energy analysis. *Renewable Energy* 2015;74:271–8.
- [68] Buker MS, Riffat SB. Build-up and performance test of a novel solar thermal roof for heat pump operation. *Int J Ambient Energy* 2017;38(4):365–79.
- [69] https://www.volker-quaschnig.de/datserv/CO2-spez/index_e.php.