



HAL
open science

Easy Applied Sciences Learning through Open Source Remote Laboratory

Camille Lavayssière, B. Letowski, Benoît Larroque, Franck Luthon

► **To cite this version:**

Camille Lavayssière, B. Letowski, Benoît Larroque, Franck Luthon. Easy Applied Sciences Learning through Open Source Remote Laboratory. 11th Annual Int. Conf. Education, Research and Innovation (ICERI2018), Nov 2018, Seville, Spain. hal-01910013

HAL Id: hal-01910013

<https://univ-pau.hal.science/hal-01910013v1>

Submitted on 28 Jul 2019

HAL is a multi-disciplinary open access archive for the deposit and dissemination of scientific research documents, whether they are published or not. The documents may come from teaching and research institutions in France or abroad, or from public or private research centers.

L'archive ouverte pluridisciplinaire **HAL**, est destinée au dépôt et à la diffusion de documents scientifiques de niveau recherche, publiés ou non, émanant des établissements d'enseignement et de recherche français ou étrangers, des laboratoires publics ou privés.

EASY APPLIED SCIENCES LEARNING THROUGH OPEN SOURCE REMOTE LABORATORY

Camille Lavayssière¹, Bastien Letowski¹, Benoît Larroque¹ and Franck Luthon¹

¹Univ. Pau & Pays Adour/ E2S UPPA, IUT Bayonne Institute of Technology, Anglet, 64600 France

Abstract

The development in numerical technologies modifies and shapes interests of today's students but it also makes possible the emergence of new pedagogical tools as remote laboratories. The instrumentation of technological systems and distant interfaces offers new possibility for a distant learner and it takes more into account the student's interest in internet, web communication and gaming. The remote laboratory platform, designed with this objective, is running and evolving since 2009. In this paper, we present the evolution from a proprietary solution to an open source solution. So, informatics and electronics developments are needed. Based on these objectives, a novel approach using Python as unique programming language is used. A generic PCB (Printed Circuit Board) approach has been designed to answer robustness and adaptive needs. These developments will help to reduce the cost of the remote laboratory and give more flexibility to use it on wide applied sciences practical works.

Keywords: e-learning, game-based learning, industrial engineering, labwork, student motivation, online education, virtual instrument, remote laboratory, SCADA

1 INTRODUCTION

Distance education is growing easier and faster with the widespread use of computers and internet. Moreover, the "massification" of higher education leads to a diversification in post-secondary student profile [1]. To answer this issue, it appears decisive to create new tools for teachers and learners as remote laboratories and game-like scenarios [2]. Since 2009, we have developed and deployed a remote laboratory called LaboREM where student can build their electronic circuit with a robotic arm. The perspectives of applications with this new teaching format are various and illustrated in Figure 1.

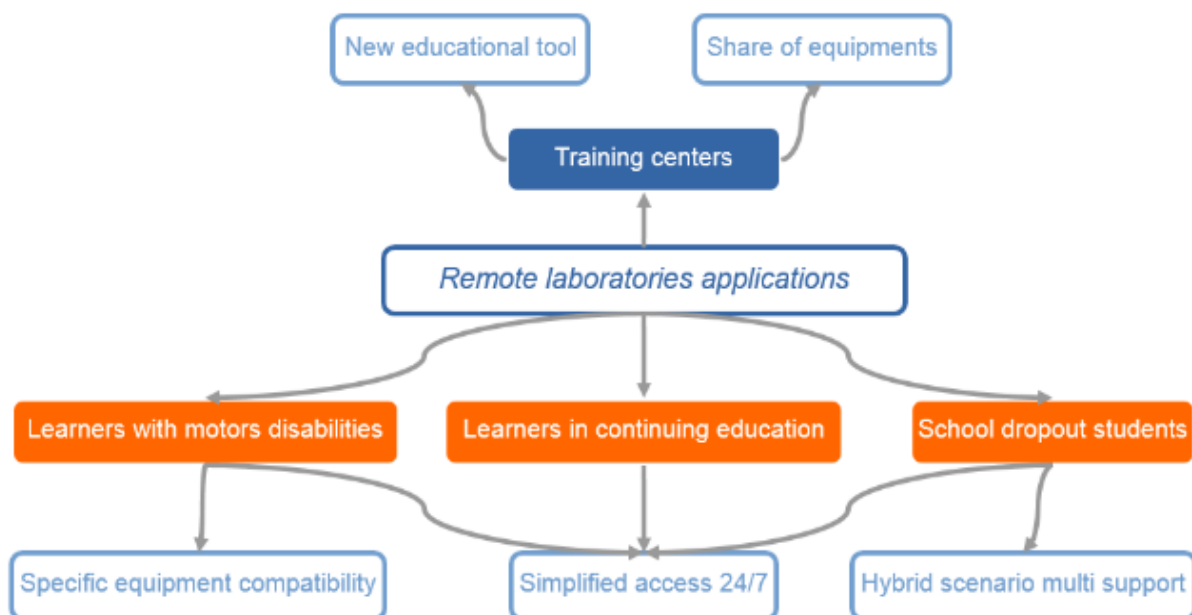

Figure 1. Applications of LaboREM in education

Creating a network of these remote laboratories can be very useful to share expensive experiments or to mutualize equipment between engineering education training centres. We would like to develop an open community to easily share practical works and to create an open source, low-cost and easy to deploy e-lab network inspired by [3], [4].

The methodology and the solution are globally presented in the second section of the article. Then, the third section describes the technical implementations in regard to important software and hardware developments. Finally, conclusions and future objectives are summarized in the last section.

2 METHODOLOGY

The most important points for a remote laboratory are summarized in the Table 1, comparing the goals and the proposition of LaboREM.

Table 1. Remote laboratory pillars and the LaboREM answer

Goals	Topics	LaboREM
Student immersion Pedagogical efficiency	Real Time Immersion	Robotic arm, camera, drone
	Real lab or simulation	Practical works
Network and collaboration	Accessibility and compatibility	Standard website
	Normalized development	Multi-protocols communication
	Cost	Open source software (Python) and hardware (generic plugs)

To describe the set-up of a generic platform, it is necessary to illustrate the issues presented and to transpose them to each part of the system. LaboREM answers these objectives (Figure 2).

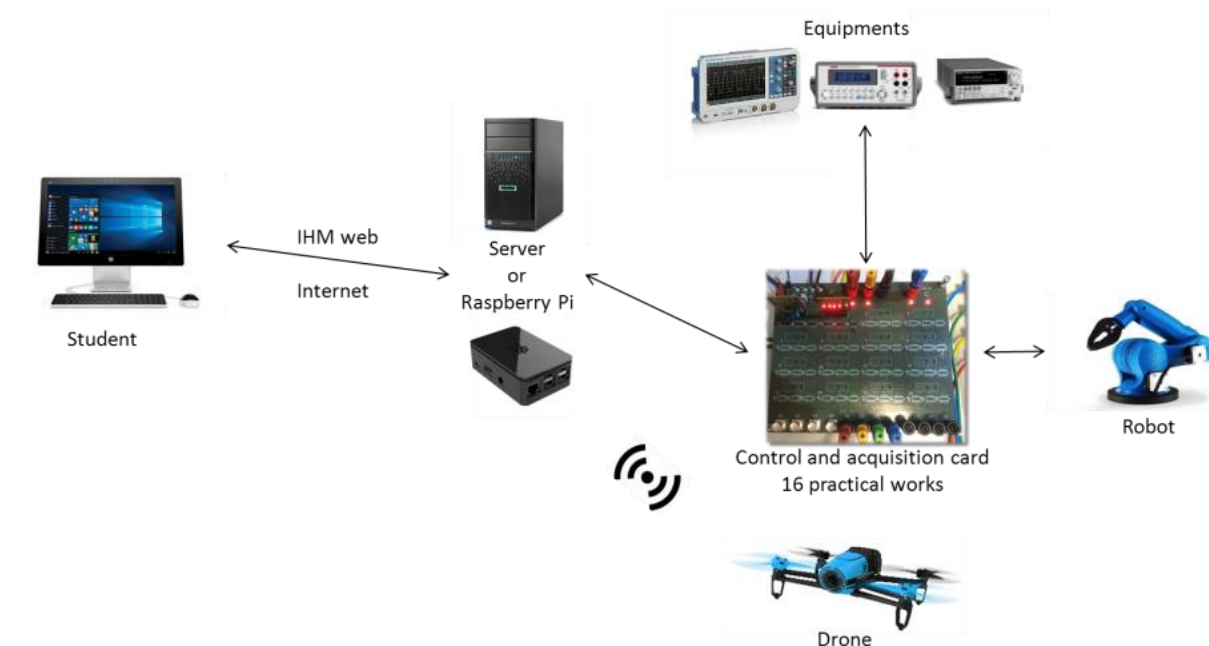

Figure 2. Diagram of LaboREM 2018

The development of LaboREM will allow to use the same equipment as the one available in hands-on work, where student's arms and eyes are replaced by the robot arm and the drone [5]. Students and teachers will be able to access to the platform from any device over the internet. The normalized developments for the software and hardware reduce the cost and allow us to share and reproduce LaboREM easily.

Figure 3 illustrates the actual prototype of LaboREM evolving since 2009 with the last updates.

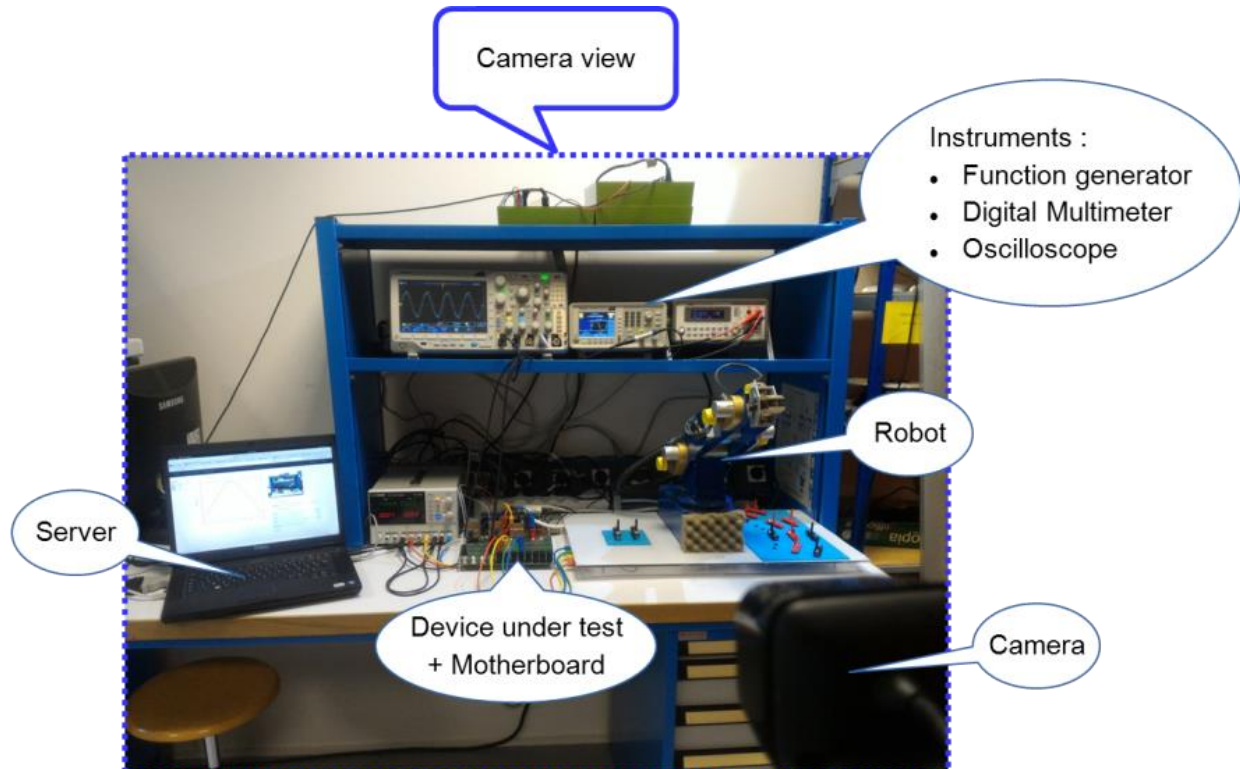

Figure 3. LaboREM 2018 hardware resources on server side

3 IMPLEMENTATION

3.1 Software Methodology

3.1.1 Server and software

The supervisory control and data acquisition (SCADA) system was developed and validated on basic electronic filters, the web human machine interface (HMI) allows to enter the values to control function generator, digital multimeter and oscilloscope. An algorithm which computes the frequency response of any filter was validated.

Previously, the SCADA system used by LaboREM ran on Windows Server operating system. The proprietary LabVIEW software from National Instruments was used for data acquisition and robot control. The cost of the software and the proprietary protocols library used by LabVIEW lead us to develop an entirely new IT system for migration to an open source and light software (Figure 4). For instance, low and medium size industries face similar issues [6] and other universities substitute LabVIEW by open source solution like the National University of Distance Education in Spain [7].

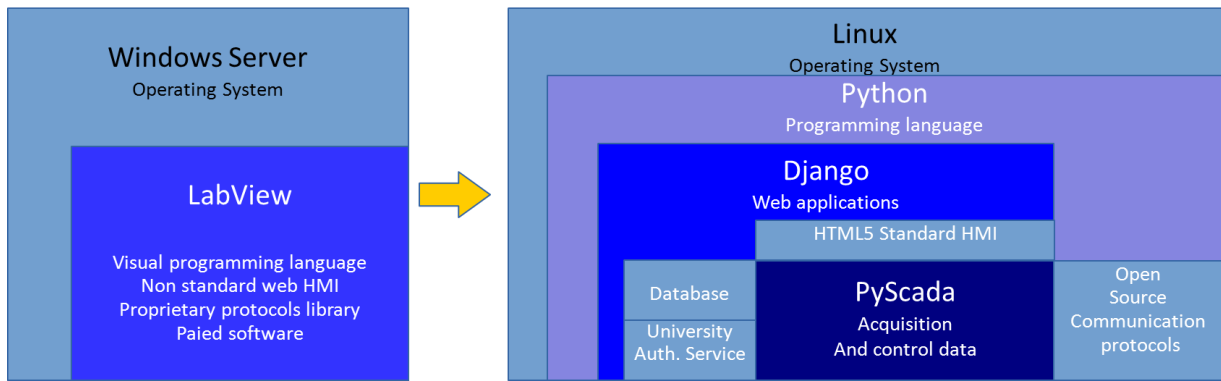

Figure 4. Diagram of the proprietary structure versus the open source structure

To ease the creation of complex, database-driven websites we use a Python framework called Django [8]. Communication with the instruments is done with the Django application PyScada. Running under Linux, the solution provides an HTML5 interface compatible with every client. Another advantage on the server side is to provide a solution which can be developed with a light and open software solution which enables to use as a server a single-board computer (SBC). The solution will be embedded in a Raspberry Pi like in [9].

The teacher can easily add the HMI web page in the learning management system (LMS) and receives real time results of the practical work: he can adapt and improve the pedagogical scenario. The authentication can be managed by the central authentication service (CAS) of the university or with Django. The integration of LaboREM is unnoticeable for students and enhances their immersion.

3.1.2 Instruments communication

The data acquisition system must be compatible with several communication protocols (VISA, Modbus, etc) and connections (serial, USB, ethernet, GPIB, etc).

To fulfill these requirements and go beyond the proprietary solutions, we can easily find in the Python community useful applications like PyUSB or PySerial. As shown in Figure 5, we have to develop the instrument commands part called by PyScada.

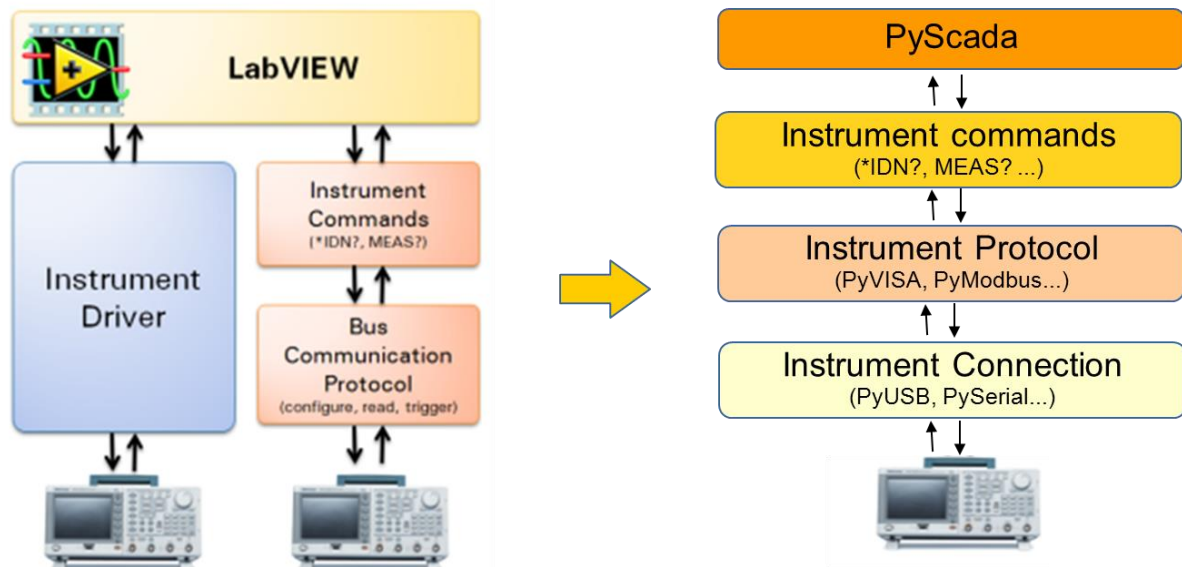

Figure 5. Instruments communication with the LabVIEW based solution and the open source proposed solution

The idea is to provide a bank of experiments scripts available for a list of instruments selected by PyScada. This bank of scripts can be filled-in by the teacher: he informs about the experiment which he wants to set-up and the instruments he has got.

3.1.3 Result and progress of the open source SCADA development

The SCADA system was developed and validated, the web HMI allows to sign in with the university ID and then to enter the values to control function generator, digital multimeter and oscilloscope. An algorithm which computes the frequency response of any filter was validated and presented on the Figure 6. It is a Bode plot of a Sallen-Key band-pass filter.

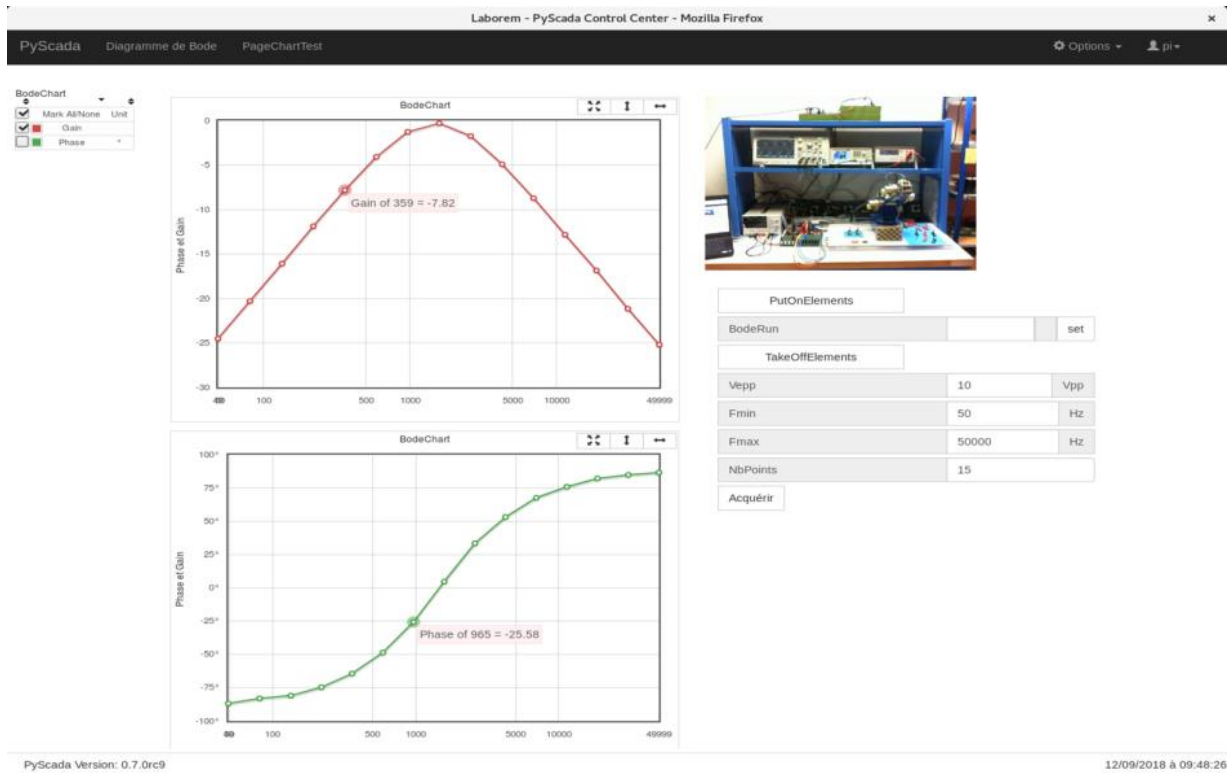

Figure 6. The Web HMI of Laborem developed under PyScada

3.2 Hardware Methodology

3.2.1 Data acquisition and control

Hardware development is also conducted. A modular motherboard where 16 different devices under test (DUT) can be plugged has been designed (

Figure 7). The motherboard receives and manages all the information of the experiment that the learner wants to work on. The learners will have access to 16 DUT to achieve their work. Each DUT can be easily replaced by the teacher to adapt the scenario to the learners. The DUT is connected to the motherboard with a generic plug, the schematic is illustrated in Fig. 8.

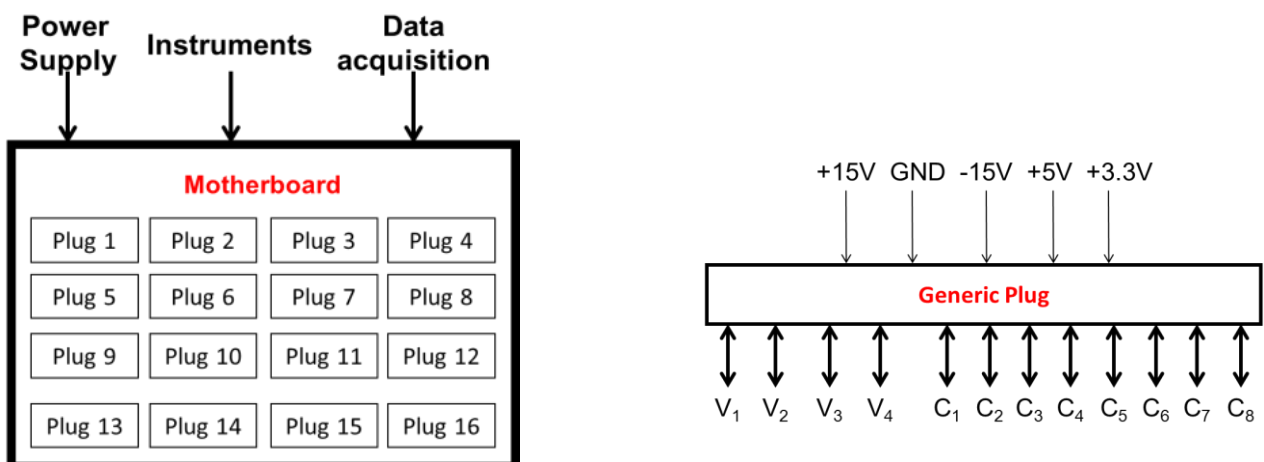

Figure 7. Block schematic of the modular motherboard

Figure 8. Pin mapping of the generic plug

Each plug is supplied with several voltages levels in order to deal with CMOS or TTL circuits and also circuits with symmetric supply. Twelve bidirectional input/outputs are present. The V_i are mainly used for voltage signals and the C_i for other connections like robot interconnection or logical signals if need by the DUT. As plugs are generic, it will be possible to interconnect different sources, multimeters and robot controller.

3.2.2 PCB design

The deployment of the new open source version of LaboREM needs the design of plugs and the motherboard. Connectors and plugs are designed in PCI Express logic because this is a well-known electronic standard. It simplifies PCB design, reduces the cost thanks to widely used connector types and assures a mechanical resistance that allows the teacher to change easily the plug on the motherboard. The modular motherboard is visible in Figure 9. A 4-wire bus and a multiplexer are used to select a plug among the 16 ones. All the different signals are isolated with switches operating by the multiplexer.

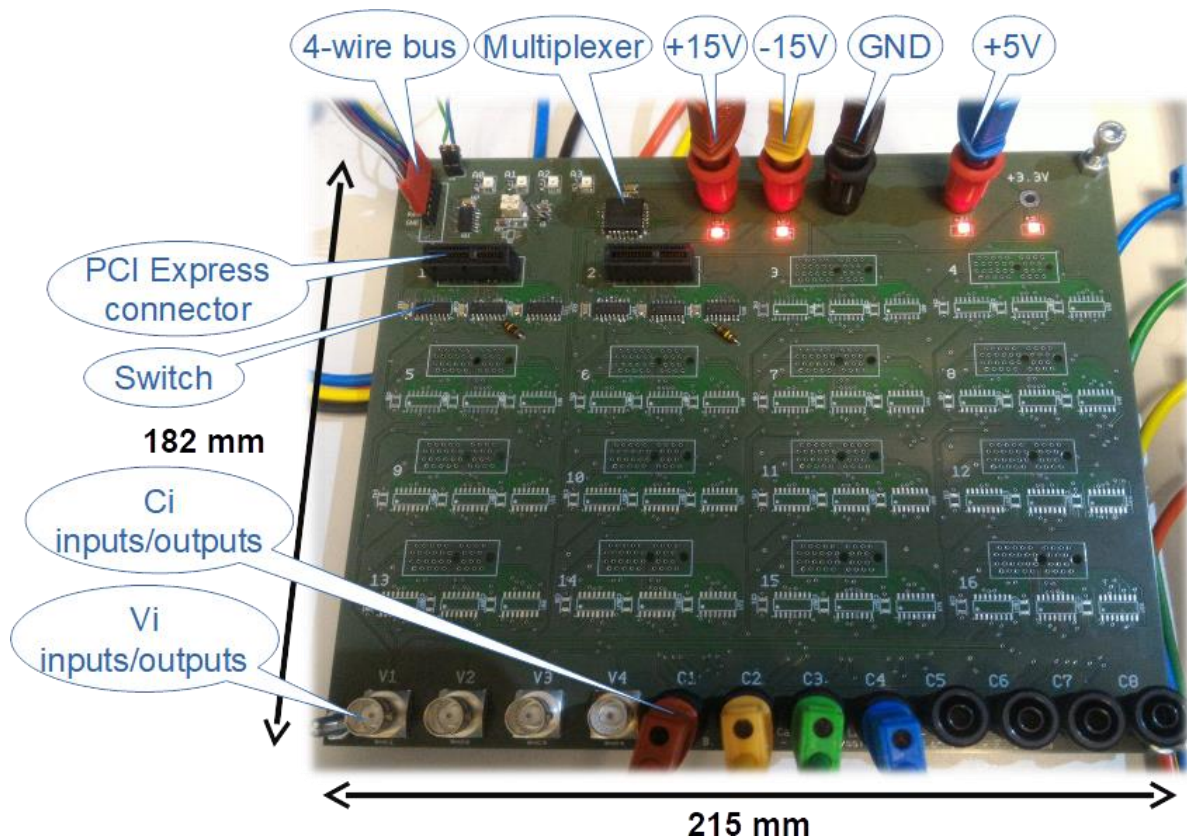

Figure 9. Top view of the motherboard; PCIe connectors are visible to interconnect plugs (only two connectors and switches are soldered on the picture)

Two examples of plugs are shown in the Figure 10.

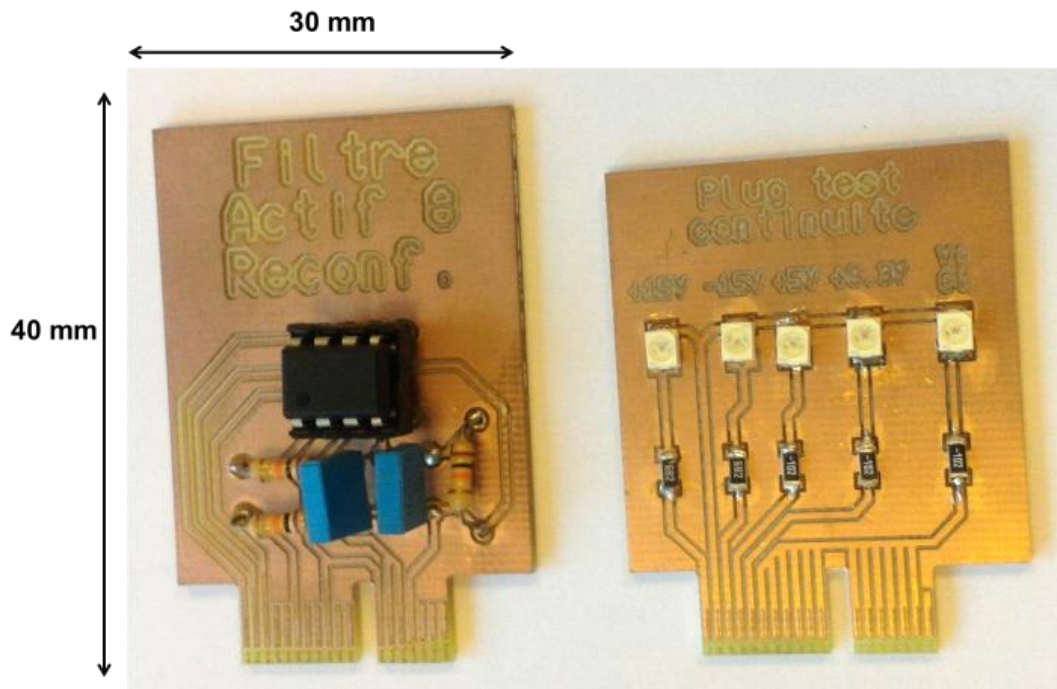

Figure 10. Plugs examples of an active filter remotely configurable by the robotic arm and a second test plug to check electrical continuity after components soldering

Finally, all the electronics parts will be stored in a “LaboREM Box” designed in our laboratory in University of Pau. The approximate size for practical works in electronics is $25 \times 25 \times 10 \text{ cm}^3$. The box will be composed of the motherboard, the different plugs, a relay to turn-off/on all the elements, a power supply and the SBC.

Moreover, PCB designs of each plug will be available as open hardware permitting community to create new DUT and to share it.

4 CONCLUSIONS

As we shown in this article, developments with open-source applications, standardized protocols and low-cost hardware set-up allow designing a solution easy to duplicate and favors interconnection of the remote labs to create a network. The solution will transfer to universities in Senegal, Burkina Faso and Germany. The second objective is to continue developments toward a full design of the “LaboREM Box” to control an easy application to applied sciences experimentation. As modular motherboard was designed, new practical DUT can be thought of in others fields in applied sciences like automatic control [7], [9], mechanics, optics [10] and renewable energies.

ACKNOWLEDGEMENTS

The authors would like to thank the staff of ISITE program E2S for financial support for the engineer fellowship of Camille Lavayssière.

REFERENCES

- [1] C. Araneda and L. Pedraja, “Massification Of Higher Education In Chile: Challenges For Chilean Universities,” *ICERI2017 Proceedings*, pp. 4356–4361, 2017.
- [2] F. Luthon and B. Larroque, “LaboREM: A Remote Laboratory for Game-Like Training in Electronics,” *IEEE Transactions on Learning Technologies*, vol. 8, no. 3, pp. 311–321, 2015.
- [3] I. Gustavsson, J. Zackrisson, L. Håkansson, I. Claesson, and T. L. Lagö, “The VISIR project – an Open Source Software Initiative for Distributed Online Laboratories,” in *DIVA*, 2007.

- [4] I. Gustavsson *et al.*, "On Objectives of Instructional Laboratories, Individual Assessment, and Use of Collaborative Remote Laboratories," *IEEE Transactions on Learning Technologies*, vol. 2, no. 4, pp. 263–274, Oct. 2009.
- [5] F. Khattar, F. Luthon, B. Larroque, and F. Dornaika, "Using Computer Vision For Student-Centred Remote Lab In Electronics," in *8th International Conference on Education and New Learning Technologies*, Barcelona, Spain, 2016, pp. 614–623.
- [6] D. F. Merchan, J. A. Peralta, A. Vazquez-Rodas, L. I. Minchala, and D. Astudillo-Salinas, "Open Source SCADA System for Advanced Monitoring of Industrial Processes," in *2017 International Conference on Information Systems and Computer Science (INCISCOS)*, Quito, 2017, pp. 160–165.
- [7] J. Sáenz, J. Chacón, L. D. L. Torre, A. Visioli, and S. Dormido, "Open and Low-Cost Virtual and Remote Labs on Control Engineering," *IEEE Access*, vol. 3, pp. 805–814, 2015.
- [8] M. Schröder, *PyScada is a open source scada system that uses the Django framework as backend: Retrieved from <https://github.com/trombastic/PyScada>*. 2018.
- [9] J. Bermúdez-Ortega, E. Besada-Portas, J. A. López-Orozco, J. A. Bonache-Seco, and J. M. de la Cruz, "Remote Web-based Control Laboratory for Mobile Devices based on EJS, Raspberry Pi and Node.js**This work has been supported by the Spanish National Research Project DPI2013-46665-C2-1-R.,," *IFAC-PapersOnLine*, vol. 48, no. 29, pp. 158–163, Jan. 2015.
- [10] D. Galan, O. Isaksson, M. Rostedt, J. Enger, D. Hanstorp, and L. de la Torre, "A remote laboratory for optical levitation of charged droplets," *European Journal of Physics*, vol. 39, no. 4, p. 045301, Jul. 2018.